

3950X SERIES
3.50mm HEADERS

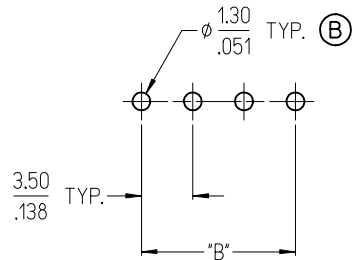

3952X & 3954X SERIES
5.00mm HEADERS
5.00mm FIXED

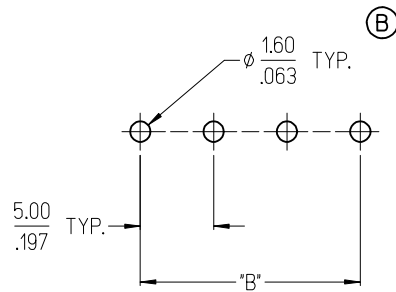

3953X SERIES
5.08mm HEADERS

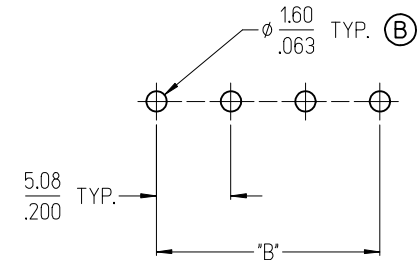

3951X SERIES
3.81mm HEADERS

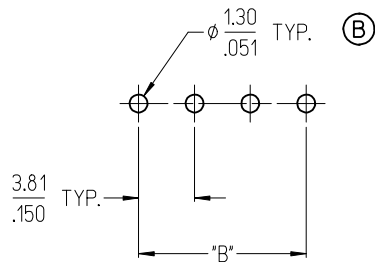

3954X SERIES
5.00mm FIXED

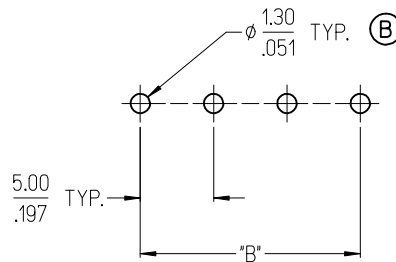

3954X SERIES
5.08mm FIXED

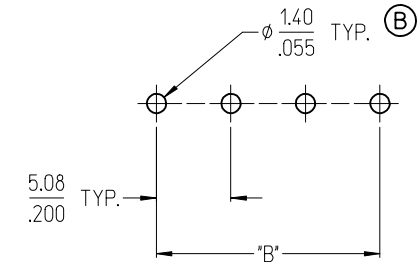

NOTES:

- REFER TO INDIVIDUAL PRODUCT SALES DRAWINGS FOR "B" DIMENSION.
- DOES NOT APPLY TO DUAL LEVEL HEADERS, SERIES 39528 AND 39538.
- TYP. = TYPICAL.

TOLERANCES			
MM	TOL	INCH	TOL
0-6	±0.25	0-.24	±.010
>6-30	±0.40	.24-1.18	±.016
>30-120	±0.50	1.18-4.76	±.020
>120	±0.80	>4.76	±.031

REVISED DOC TOL
EC NO: IPG2017-0881
DRAWN: VASUTHKARP 2017/03/23
CHKD:
APPR: BRUPERT 2017/04/18
REV DESCRIPTION

QUALITY SYMBOLS
▽=0
▽=0

GENERAL TOLERANCES (UNLESS SPECIFIED)

	mm	INCH
4 PLACES	±---	±---
3 PLACES	±---	±---
2 PLACES	±---	±---
1 PLACE	±---	±---
ANGULAR ±---°		

DRAFT WHERE APPLICABLE
MUST REMAIN
WITHIN DIMENSIONS

DIMENSION STYLE
MM/IN

DRAWN BY	DATE
C. YORK	2006/08/25
CHECKED BY	DATE
J. MACNEIL	2006/08/25
APPROVED BY	DATE
J. MACNEIL	2006/08/25

MATERIAL NO. --

SCALE DESIGN UNITS INCH

THIRD ANGLE PROJECTION

RECOMMENDED PCB LAYOUT FOR ESE TERMINAL BLOCKS

molex MOLEX INCORPORATED

DOCUMENT NO. SD-39501-002

SHEET NO. 1 OF 1

THIS DRAWING CONTAINS INFORMATION THAT IS PROPRIETARY TO MOLEX INCORPORATED AND SHOULD NOT BE USED WITHOUT WRITTEN PERMISSION

3950X SERIES
3.50mm HEADERS

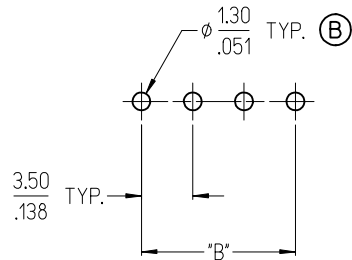

3952X & 3954X SERIES
5.00mm HEADERS
5.00mm FIXED

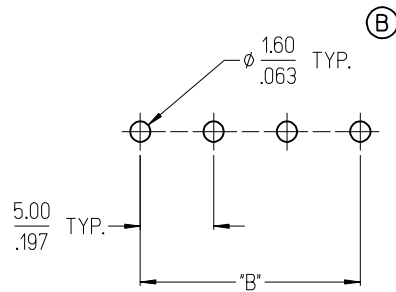

3953X SERIES
5.08mm HEADERS

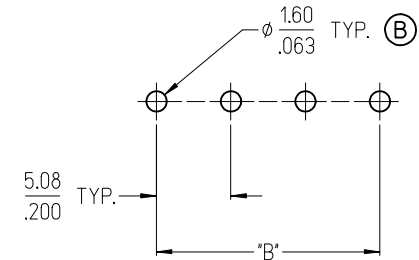

3951X SERIES
3.81mm HEADERS

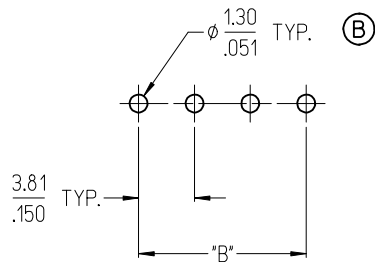

3954X SERIES
5.00mm FIXED

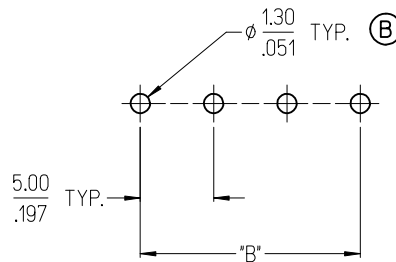

3954X SERIES
5.08mm FIXED

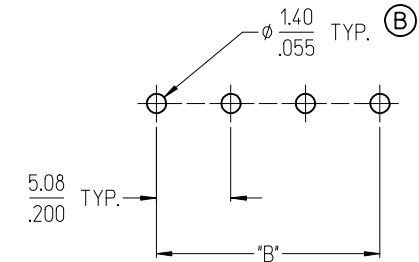

NOTES:

- REFER TO INDIVIDUAL PRODUCT SALES DRAWINGS FOR 'B' DIMENSION.
- DOES NOT APPLY TO DUAL LEVEL HEADERS, SERIES 39528 AND 39538.
- TYP. = TYPICAL.

TOLERANCES			
MM	TOL	INCH	TOL
0-6	±0.25	0-.24	±.010
>6-30	±0.40	.24-1.18	±.016
>30-120	±0.50	1.18-4.76	±.020
>120	±0.80	>4.76	±.031

REVISED DOC TOL
EC NO: IPG2017-0881
DRAWN: VASUTHKARP 2017/03/23
CHKD:
APPR: BRUPERT 2017/04/18
REV DESCRIPTION

QUALITY SYMBOLS
▽=0
▽=0

GENERAL TOLERANCES (UNLESS SPECIFIED)

	mm	INCH
4 PLACES	±---	±---
3 PLACES	±---	±---
2 PLACES	±---	±---
1 PLACE	±---	±---
ANGULAR ±---°		

DRAFT WHERE APPLICABLE
MUST REMAIN
WITHIN DIMENSIONS

DIMENSION STYLE
MM/IN

DRAWN BY	DATE
C. YORK	2006/08/25
CHECKED BY	DATE
J. MACNEIL	2006/08/25
APPROVED BY	DATE
J. MACNEIL	2006/08/25

MATERIAL NO. --

SCALE DESIGN UNITS INCH

THIRD ANGLE PROJECTION

RECOMMENDED PCB LAYOUT FOR ESE TERMINAL BLOCKS

molex MOLEX INCORPORATED

DOCUMENT NO. SD-39501-002

SHEET NO. 1 OF 1

THIS DRAWING CONTAINS INFORMATION THAT IS PROPRIETARY TO MOLEX INCORPORATED AND SHOULD NOT BE USED WITHOUT WRITTEN PERMISSION

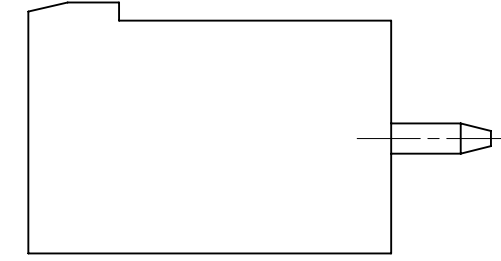
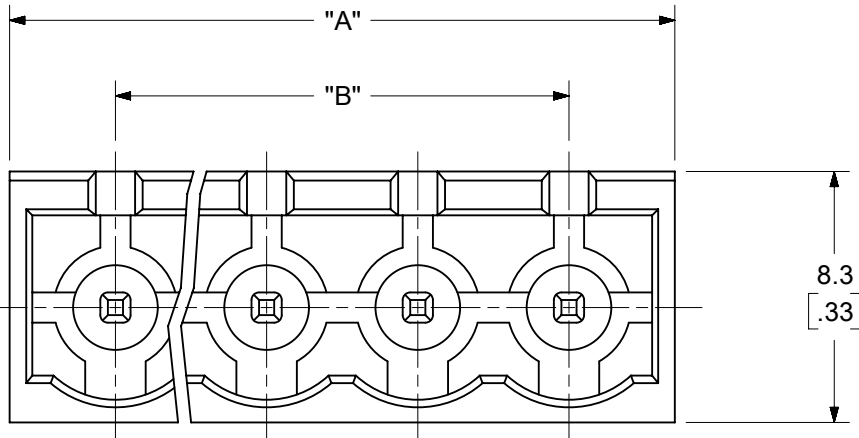
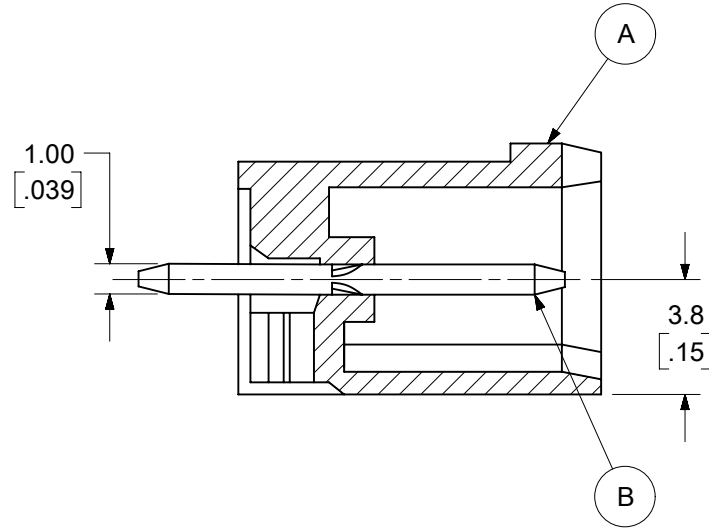
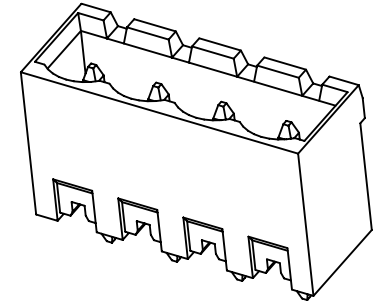
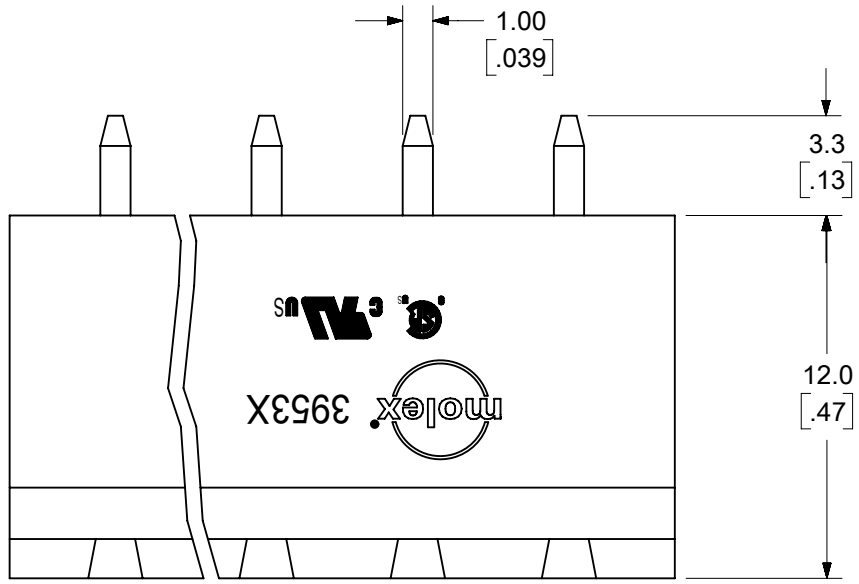
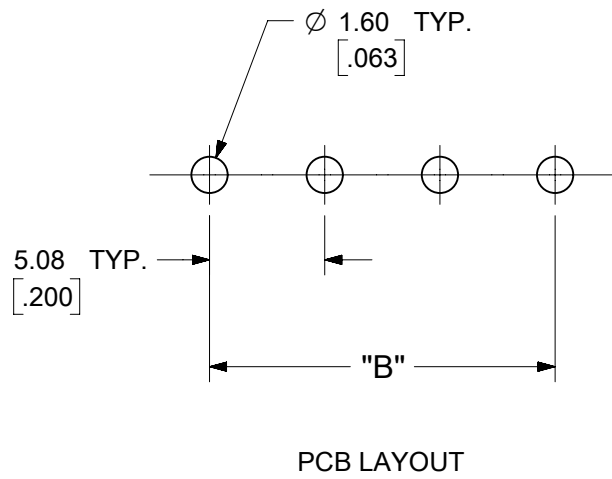

SPECIFICATIONS:

1. MATERIAL:
 - (A). BODY: PA66
 - (B). PIN: BRASS
2. WIRE RANGE: N/A
3. ELECTRICAL RATING: 300V, 15A.
4. WIRE STRIP LENGTH: N/A.
5. OPERATING TEMPERATURE: -40°C to +105°C.
6. MAX TORQUE: N/A.
7. INSULATION RESISTANCE: DC 500V, 500M.
8. DIELECTRIC WITHSTAND: AC 2500V FOR 1 MINUTE.
9. BREAKDOWN VOLTAGE : 4000V.
10. $A = (N \times P) + 2.0MM$
11. $B = (N - 1) \times P$
12. P (PITCH) = 5.08MM (.200").
13. N = NUMBER OF POSITIONS AVAILABLE 2 THROUGH 24.
14. DIMS SHOWN ARE FOR REFERENCE ONLY.

TOLERANCES			
MM	TOL	INCH	TOL
0-6	±0.25	0-.24	±.010
>6-30	±0.40	.24-1.18	±.016
>30-120	±0.50	1.18-4.76	±.020
>120	±0.80	>4.76	±.031

SYMBOLS DIMENSION UNITS: MM/INCH SCALE: 4:1 CURRENT REV DESC: MIGRATION TO ECTR/NX EC NO: 623382 DRWN: ABENJAMINLW 2019/07/18 CHK'D: DACHAMMER 2019/09/03 APPR: JFMURPHY 2019/09/26 INITIAL REVISION: DRWN: LROTHAUS 2006/01/09 APPR: JPAWLICK 2006/01/10			
	5.08MM, EURO HEADER, VERTICAL		
PRODUCT CUSTOMER DRAWING DOCUMENT NUMBER: SD-39531-002 DOC TYPE: PSD DOC PART: 001 REVISION: A2			
MATERIAL NUMBER: SEE SHEET-2 CUSTOMER: GENERAL MARKET SHEET NUMBER: 1 OF 2			

		MATERIAL NUMBERS				DIMENSIONAL INFORMATION												
		BLACK				GREEN				DIM. "A"				DIM. "B"				
		100% TIN		30 u" GOLD		100% TIN		30 u" GOLD		DIM. "A"		DIM. "B"						
		PRINTING OPTIONS			PRINTING OPTIONS			PRINTING OPTIONS			PRINTING OPTIONS			DIM. "A"		DIM. "B"		
		CIRCUIT SIZE	None	10AV	11AV	None	10AV	11AV	None	10AV	11AV	None	10AV	11AV	mm	inch	mm	inch
DESCRIPTION																		
	5.08 MM, EURO HEADER, VERTICAL	2	395311002	395311302	395311402	395311502	395311802	395311902	395316002	395316302	395316402	395316502	395316802	395316902	12.16	.479	5.08	.200
	5.08 MM, EURO HEADER, VERTICAL	3	395311003	395311303	395311403	395311503	395311803	395311903	395316003	395316303	395316403	395316503	395316803	395316903	17.24	.679	10.16	.400
	5.08 MM, EURO HEADER, VERTICAL	4	395311004	395311304	395311404	395311504	395311804	395311904	395316004	395316304	395316404	395316504	395316804	395316904	22.32	.879	15.24	.600
	5.08 MM, EURO HEADER, VERTICAL	5	395311005	395311305	395311405	395311505	395311805	395311905	395316005	395316305	395316405	395316505	395316805	395316905	27.40	1.079	20.32	.800
	5.08 MM, EURO HEADER, VERTICAL	6	395311006	395311306	395311406	395311506	395311806	395311906	395316006	395316306	395316406	395316506	395316806	395316906	32.48	1.279	25.40	1.000
	5.08 MM, EURO HEADER, VERTICAL	7	395311007	395311307	395311407	395311507	395311807	395311907	395316007	395316307	395316407	395316507	395316807	395316907	37.56	1.479	30.48	1.200
	5.08 MM, EURO HEADER, VERTICAL	8	395311008	395311308	395311408	395311508	395311808	395311908	395316008	395316308	395316408	395316508	395316808	395316908	42.64	1.679	35.56	1.400
	5.08 MM, EURO HEADER, VERTICAL	9	395311009	395311309	395311409	395311509	395311809	395311909	395316009	395316309	395316409	395316509	395316809	395316909	47.72	1.879	40.64	1.600
	5.08 MM, EURO HEADER, VERTICAL	10	395311010	395311310	395311410	395311510	395311810	395311910	395316010	395316310	395316410	395316510	395316810	395316910	52.80	2.079	45.72	1.800
	5.08 MM, EURO HEADER, VERTICAL	11	395311011	395311311	395311411	395311511	395311811	395311911	395316011	395316311	395316411	395316511	395316811	395316911	57.88	2.279	50.80	2.000
	5.08 MM, EURO HEADER, VERTICAL	12	395311012	395311312	395311412	395311512	395311812	395311912	395316012	395316312	395316412	395316512	395316812	395316912	62.96	2.479	55.88	2.200
	5.08 MM, EURO HEADER, VERTICAL	13	395311013	395311313	395311413	395311513	395311813	395311913	395316013	395316313	395316413	395316513	395316813	395316913	68.04	2.679	60.96	2.400
	5.08 MM, EURO HEADER, VERTICAL	14	395311014	395311314	395311414	395311514	395311814	395311914	395316014	395316314	395316414	395316514	395316814	395316914	73.12	2.879	66.04	2.600
	5.08 MM, EURO HEADER, VERTICAL	15	395311015	395311315	395311415	395311515	395311815	395311915	395316015	395316315	395316415	395316515	395316815	395316915	78.20	3.079	71.12	2.800
	5.08 MM, EURO HEADER, VERTICAL	16	395311016	395311316	395311416	395311516	395311816	395311916	395316016	395316316	395316416	395316516	395316816	395316916	83.28	3.279	76.20	3.000
	5.08 MM, EURO HEADER, VERTICAL	17	395311017	395311317	395311417	395311517	395311817	395311917	395316017	395316317	395316417	395316517	395316817	395316917	88.36	3.479	81.28	3.200
	5.08 MM, EURO HEADER, VERTICAL	18	395311018	395311318	395311418	395311518	395311818	395311918	395316018	395316318	395316418	395316518	395316818	395316918	93.44	3.679	86.36	3.400
	5.08 MM, EURO HEADER, VERTICAL	19	395311019	395311319	395311419	395311519	395311819	395311919	395316019	395316319	395316419	395316519	395316819	395316919	98.52	3.879	91.44	3.600
	5.08 MM, EURO HEADER, VERTICAL	20	395311020	395311320	395311420	395311520	395311820	395311920	395316020	395316320	395316420	395316520	395316820	395316920	103.60	4.079	96.52	3.800
	5.08 MM, EURO HEADER, VERTICAL	21	395311021	395311321	395311421	395311521	395311821	395311921	395316021	395316321	395316421	395316521	395316821	395316921	108.68	4.279	101.60	4.000
	5.08 MM, EURO HEADER, VERTICAL	22	395311022	395311322	395311422	395311522	395311822	395311922	395316022	395316322	395316422	395316522	395316822	395316922	113.76	4.479	106.68	4.200
	5.08 MM, EURO HEADER, VERTICAL	23	395311023	395311323	395311423	395311523	395311823	395311923	395316023	395316323	395316423	395316523	395316823	395316923	118.84	4.679	111.76	4.400
	5.08 MM, EURO HEADER, VERTICAL	24	395311024	395311324	395311424	395311524	395311824	395311924	395316024	395316324	395316424	395316524	395316824	395316924	123.92	4.879	116.84	4.600



TOLERANCES			
MM	TOL	INCH	TOL
0-6	±0.25	0-.24	±.010
>6-30	±0.40	.24-1.18	±.016
>30-120	±0.50	1.18-4.76	±.020
>120	±0.80	>4.76	±.031

SYMBOLS		THIS DRAWING CONTAINS INFORMATION THAT IS PROPRIETARY TO MOLEX ELECTRONIC TECHNOLOGIES, LLC AND SHOULD NOT BE USED WITHOUT WRITTEN PERMISSION	
▽ = 0	DIMENSION UNITS	SCALE	CURRENT REV DESC: MIGRATION TO ECTR/NX
▽ = 0	MM/INCH	4:1	
▽ = 0	GENERAL TOLERANCES (UNLESS SPECIFIED)		EC NO: 623382
▽ = 0	4 PLACES ± --- ± ---		DRWN: ABENJAMINLW 2019/07/18
▽ = 0	3 PLACES ± --- ± SEE CHART		CHK'D: DACHAMMER 2019/09/03
▽ = 0	2 PLACES ± SEE CHART ± SEE CHART		APPR: JFMURPHY 2019/09/26
▽ = 0	1 PLACE ± SEE CHART ± ---		INITIAL REVISION:
▽ = 0	0 PLACES ± --- ± ---		DRWN: LROTHAUS 2006/01/09
▽ = 0	ANGULAR TOL ± ---		APPR: JPAWLICK 2006/01/10
▽ = 0	DRAFT WHERE APPLICABLE MUST REMAIN WITHIN DIMENSIONS	THIRD ANGLE PROJECTION	DRAWING
▽ = 0			SERIES
		B-SIZE	39531
		MATERIAL NUMBER	CUSTOMER
		SEE TABLE	GENERAL MARKET
		DOCUMENT NUMBER	DOC TYPE DOC PART REVISION
		SD-39531-002	PSD 001 A2
			SHEET NUMBER
			2 OF 2

Description	Circuit size	Material Numbers										Dimensional Information					
		Black					Green										
		100% Tin			30 u" Gold			100% Tin			30 u" Gold			Dim. A		Dim B	
		Printing Options			Printing Options			Printing Options			Printing Options						
None	10AV	11AV	None	10AV	11AV	None	10AV	11AV	None	10AV	11AV	mm	inch	mm	inch		
5.08mm, Euro Header, Vertical	2	395311002	395311302	395311402	395311502	395311802	395311902	395316002	395316302	395316402	395316502	395316602	395316902	12.16	0.479	5.08	0.200
5.08mm, Euro Header, Vertical	3	395311003	395311303	395311403	395311503	395311803	395311903	395316003	395316303	395316403	395316503	395316603	395316903	17.24	0.679	10.16	0.400
5.08mm, Euro Header, Vertical	4	395311004	395311304	395311404	395311504	395311804	395311904	395316004	395316304	395316404	395316504	395316604	395316904	22.32	0.879	15.24	0.600
5.08mm, Euro Header, Vertical	5	395311005	395311305	395311405	395311505	395311805	395311905	395316005	395316305	395316405	395316505	395316605	395316905	27.40	1.079	20.32	0.800
5.08mm, Euro Header, Vertical	6	395311006	395311306	395311406	395311506	395311806	395311906	395316006	395316306	395316406	395316506	395316606	395316906	32.48	1.279	25.40	1.000
5.08mm, Euro Header, Vertical	7	395311007	395311307	395311407	395311507	395311807	395311907	395316007	395316307	395316407	395316507	395316607	395316907	37.56	1.479	30.48	1.200
5.08mm, Euro Header, Vertical	8	395311008	395311308	395311408	395311508	395311808	395311908	395316008	395316308	395316408	395316508	395316608	395316908	42.64	1.679	35.56	1.400
5.08mm, Euro Header, Vertical	9	395311009	395311309	395311409	395311509	395311809	395311909	395316009	395316309	395316409	395316509	395316609	395316909	47.72	1.879	40.64	1.600
5.08mm, Euro Header, Vertical	10	395311010	395311310	395311410	395311510	395311810	395311910	395316010	395316310	395316410	395316510	395316610	395316910	52.80	2.079	45.72	1.800
5.08mm, Euro Header, Vertical	11	395311011	395311311	395311411	395311511	395311811	395311911	395316011	395316311	395316411	395316511	395316611	395316911	57.88	2.279	50.80	2.000
5.08mm, Euro Header, Vertical	12	395311012	395311312	395311412	395311512	395311812	395311912	395316012	395316312	395316412	395316512	395316612	395316912	62.96	2.479	55.88	2.200
5.08mm, Euro Header, Vertical	13	395311013	395311313	395311413	395311513	395311813	395311913	395316013	395316313	395316413	395316513	395316613	395316913	68.04	2.679	60.96	2.400
5.08mm, Euro Header, Vertical	14	395311014	395311314	395311414	395311514	395311814	395311914	395316014	395316314	395316414	395316514	395316614	395316914	73.12	2.879	66.04	2.600
5.08mm, Euro Header, Vertical	15	395311015	395311315	395311415	395311515	395311815	395311915	395316015	395316315	395316415	395316515	395316615	395316915	78.20	3.079	71.12	2.800
5.08mm, Euro Header, Vertical	16	395311016	395311316	395311416	395311516	395311816	395311916	395316016	395316316	395316416	395316516	395316616	395316916	83.28	3.279	76.20	3.000
5.08mm, Euro Header, Vertical	17	395311017	395311317	395311417	395311517	395311817	395311917	395316017	395316317	395316417	395316517	395316617	395316917	88.36	3.479	81.28	3.200
5.08mm, Euro Header, Vertical	18	395311018	395311318	395311418	395311518	395311818	395311918	395316018	395316318	395316418	395316518	395316618	395316918	93.44	3.679	86.36	3.400
5.08mm, Euro Header, Vertical	19	395311019	395311319	395311419	395311519	395311819	395311919	395316019	395316319	395316419	395316519	395316619	395316919	98.52	3.879	91.44	3.600
5.08mm, Euro Header, Vertical	20	395311020	395311320	395311420	395311520	395311820	395311920	395316020	395316320	395316420	395316520	395316620	395316920	103.60	4.079	96.52	3.800
5.08mm, Euro Header, Vertical	21	395311021	395311321	395311421	395311521	395311821	395311921	395316021	395316321	395316421	395316521	395316621	395316921	108.68	4.279	101.60	4.000
5.08mm, Euro Header, Vertical	22	395311022	395311322	395311422	395311522	395311822	395311922	395316022	395316322	395316422	395316522	395316622	395316922	113.76	4.479	106.68	4.200
5.08mm, Euro Header, Vertical	23	395311023	395311323	395311423	395311523	395311823	395311923	395316023	395316323	395316423	395316523	395316623	395316923	118.84	4.679	111.76	4.400
5.08mm, Euro Header, Vertical	24	395311024	395311324	395311424	395311524	395311824	395311924	395316024	395316324	395316424	395316524	395316624	395316924	123.92	4.879	116.84	4.600

TOLERANCES			
MM	TOL	INCH	TOL
0-6	±0.25	0-.24	±.010
>6-30	±0.40	.24-1.18	±.016
>30-120	±0.50	1.18-4.76	±.020
>120	±0.80	>4.76	±.031

REVISED DOC TOL
 EC NO: IPG2017-0861
 DRAWN: CRADDREWS 2017/03/23
 CHKD:
 APPR: BRUPERT 2017/04/18

QUALITY SYMBOLS
 = 0
 = 0.05

GENERAL TOLERANCES (UNLESS SPECIFIED)

	mm	INCH
4 PLACES	± ---	± ---
3 PLACES	± ---	± ---
2 PLACES	± ---	± ---
1 PLACE	± ---	± ---

ANGULAR ± ---°

DRAFT WHERE APPLICABLE
 MUST REMAIN WITHIN DIMENSIONS

DIMENSION STYLE
MM/IN

DRAWN BY DATE
 LROTHAUS 12/6/05

CHECKED BY DATE
 C. YORK 01/04/06

APPROVED BY DATE

SCALE DESIGN UNITS
 INCH

THIRD ANGLE PROJECTION

TITLE
5.08MM, EURO HEADER, VERTICAL

 **MOLEX INCORPORATED**

MATERIAL NO. DOCUMENT NO.
SEE CHART SD-39531-002



SHEET NO.
 2 OF 2

THIS DRAWING CONTAINS INFORMATION THAT IS PROPRIETARY TO MOLEX INCORPORATED AND SHOULD NOT BE USED WITHOUT WRITTEN PERMISSION

Description	Circuit size	Material Numbers										Dimensional Information					
		Black					Green										
		100% Tin			30 u" Gold			100% Tin			30 u" Gold			Dim. A		Dim B	
		Printing Options			Printing Options			Printing Options			Printing Options						
None	10AV	11AV	None	10AV	11AV	None	10AV	11AV	None	10AV	11AV	mm	inch	mm	inch		
5.08mm, Euro Header, Vertical	2	395311002	395311302	395311402	395311502	395311802	395311902	395316002	395316302	395316402	395316502	395316802	395316902	12.18	0.479	5.08	0.200
5.08mm, Euro Header, Vertical	3	395311003	395311303	395311403	395311503	395311803	395311903	395316003	395316303	395316403	395316503	395316803	395316903	17.24	0.679	10.16	0.400
5.08mm, Euro Header, Vertical	4	395311004	395311304	395311404	395311504	395311804	395311904	395316004	395316304	395316404	395316504	395316804	395316904	22.30	0.879	15.24	0.600
5.08mm, Euro Header, Vertical	5	395311005	395311305	395311405	395311505	395311805	395311905	395316005	395316305	395316405	395316505	395316805	395316905	27.40	1.079	20.32	0.800
5.08mm, Euro Header, Vertical	6	395311006	395311306	395311406	395311506	395311806	395311906	395316006	395316306	395316406	395316506	395316806	395316906	32.48	1.279	25.40	1.000
5.08mm, Euro Header, Vertical	7	395311007	395311307	395311407	395311507	395311807	395311907	395316007	395316307	395316407	395316507	395316807	395316907	37.56	1.479	30.48	1.200
5.08mm, Euro Header, Vertical	8	395311008	395311308	395311408	395311508	395311808	395311908	395316008	395316308	395316408	395316508	395316808	395316908	42.64	1.679	35.56	1.400
5.08mm, Euro Header, Vertical	9	395311009	395311309	395311409	395311509	395311809	395311909	395316009	395316309	395316409	395316509	395316809	395316909	47.72	1.879	40.64	1.600
5.08mm, Euro Header, Vertical	10	395311010	395311310	395311410	395311510	395311810	395311910	395316010	395316310	395316410	395316510	395316810	395316910	52.80	2.079	45.72	1.800
5.08mm, Euro Header, Vertical	11	395311011	395311311	395311411	395311511	395311811	395311911	395316011	395316311	395316411	395316511	395316811	395316911	57.88	2.279	50.80	2.000
5.08mm, Euro Header, Vertical	12	395311012	395311312	395311412	395311512	395311812	395311912	395316012	395316312	395316412	395316512	395316812	395316912	62.96	2.479	55.88	2.200
5.08mm, Euro Header, Vertical	13	395311013	395311313	395311413	395311513	395311813	395311913	395316013	395316313	395316413	395316513	395316813	395316913	68.04	2.679	60.96	2.400
5.08mm, Euro Header, Vertical	14	395311014	395311314	395311414	395311514	395311814	395311914	395316014	395316314	395316414	395316514	395316814	395316914	73.12	2.879	66.04	2.600
5.08mm, Euro Header, Vertical	15	395311015	395311315	395311415	395311515	395311815	395311915	395316015	395316315	395316415	395316515	395316815	395316915	78.20	3.079	71.12	2.800
5.08mm, Euro Header, Vertical	16	395311016	395311316	395311416	395311516	395311816	395311916	395316016	395316316	395316416	395316516	395316816	395316916	83.28	3.279	76.20	3.000
5.08mm, Euro Header, Vertical	17	395311017	395311317	395311417	395311517	395311817	395311917	395316017	395316317	395316417	395316517	395316817	395316917	88.36	3.479	81.28	3.200
5.08mm, Euro Header, Vertical	18	395311018	395311318	395311418	395311518	395311818	395311918	395316018	395316318	395316418	395316518	395316818	395316918	93.44	3.679	86.36	3.400
5.08mm, Euro Header, Vertical	19	395311019	395311319	395311419	395311519	395311819	395311919	395316019	395316319	395316419	395316519	395316819	395316919	98.52	3.879	91.44	3.600
5.08mm, Euro Header, Vertical	20	395311020	395311320	395311420	395311520	395311820	395311920	395316020	395316320	395316420	395316520	395316820	395316920	103.60	4.079	96.52	3.800
5.08mm, Euro Header, Vertical	21	395311021	395311321	395311421	395311521	395311821	395311921	395316021	395316321	395316421	395316521	395316821	395316921	108.68	4.279	101.60	4.000
5.08mm, Euro Header, Vertical	22	395311022	395311322	395311422	395311522	395311822	395311922	395316022	395316322	395316422	395316522	395316822	395316922	113.76	4.479	106.68	4.200
5.08mm, Euro Header, Vertical	23	395311023	395311323	395311423	395311523	395311823	395311923	395316023	395316323	395316423	395316523	395316823	395316923	118.84	4.679	111.76	4.400
5.08mm, Euro Header, Vertical	24	395311024	395311324	395311424	395311524	395311824	395311924	395316024	395316324	395316424	395316524	395316824	395316924	123.92	4.879	116.84	4.600

TOLERANCES			
MM	TOL	INCH	TOL
0-6	±0.25	0-.24	±.010
>6-30	±0.40	.24-1.18	±.016
>30-120	±0.50	1.18-4.76	±.020
>120	±0.80	>4.76	±.031

REVISED DOC TOL
 EC NO: IPG2017-0861
 DRAWN: CRADDREWS 2017/03/23
 CHKD:
 APPR: BRUPERT 2017/04/18

QUALITY SYMBOLS
 = 0
 = 0.05

GENERAL TOLERANCES (UNLESS SPECIFIED)

	mm	INCH
4 PLACES	± ---	± ---
3 PLACES	± ---	± ---
2 PLACES	± ---	± ---
1 PLACE	± ---	± ---

ANGULAR ± ---°

DRAFT WHERE APPLICABLE
 MUST REMAIN WITHIN DIMENSIONS

DIMENSION STYLE
MM/IN

DRAWN BY DATE
 LROTHAUS 12/6/05

CHECKED BY DATE
 C. YORK 01/04/06

APPROVED BY DATE

SCALE DESIGN UNITS
 INCH

THIRD ANGLE PROJECTION

TITLE
5.08MM, EURO HEADER, VERTICAL

 **MOLEX INCORPORATED**

MATERIAL NO. DOCUMENT NO.
SEE CHART SD-39531-002

SHEET NO.
 2 OF 2

THIS DRAWING CONTAINS INFORMATION THAT IS PROPRIETARY TO MOLEX INCORPORATED AND SHOULD NOT BE USED WITHOUT WRITTEN PERMISSION