

## 300 mA low quiescent current very low noise LDO (automotive for SOT23-5L package)

Datasheet - production data

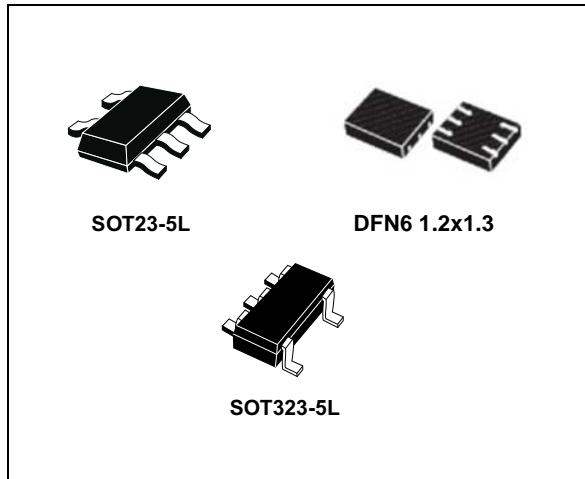

### Applications

- Mobile phones
- Portable consumer and industrial devices
- Cordless phones and similar battery-powered systems
- Automotive P.O.L.
- A.D.A.S.

### Description

The LDK130 low drop voltage regulator provides 300 mA of maximum current from an input supply voltage in the range of 1.9 V to 5.5 V, with a typical dropout voltage of 100 mV.

It is stabilized with a ceramic capacitor on the output.

The very low drop voltage, low quiescent current and low-noise features make it suitable for low-power battery-powered applications.

An enable logic control function puts the LDK130 in shutdown mode allowing a total current consumption lower than 1  $\mu$ A.

The device also includes short-circuit constant current limiting and thermal protection.

### Features



- AEC-Q100 qualified (automotive grade 1, SOT23-5L package)
- Input voltage from 1.9 to 5.5 V
- Very low-dropout voltage (100 mV typ. at 100 mA load)
- Low quiescent current (typ. 30  $\mu$ A, 1  $\mu$ A in OFF mode)
- Very low noise
- Output voltage tolerance:  $\pm 2.0\%$  at 25  $^{\circ}$ C
- 300 mA guaranteed output current
- Wide range of fixed output voltages available on request: from 0.8 V to 3.5 V with 100 mV step
- Adjustable version: from 0.8 V to  $V_{IN} - V_{drop}$
- Logic-controlled electronic shutdown
- Compatible with ceramic capacitor  $C_{OUT} = 1 \mu$ F
- Internal current and thermal limit
- Available in SOT23-5L, SOT323-5L and DFN6 1.2x1.3 packages
- Temperature range: -40  $^{\circ}$ C to 125  $^{\circ}$ C

# Contents

- 1      Block diagram ..... 5**
- 2      Pin configuration ..... 6**
- 3      Typical application ..... 7**
- 4      Maximum ratings ..... 8**
- 5      Electrical characteristics ..... 9**
- 6      Typical performance characteristics ..... 11**
- 7      Package information ..... 17**
  - 7.1 SOT23-5L package information ..... 17
  - 7.2 DFN6 1.2 x 1.3 package information ..... 19
  - 7.3 SOT323-5L package information ..... 21
  - 7.4 Packing information ..... 23
  - 7.5 SOT23-5L and SOT323-5L packing information ..... 23
- 8      Order code ..... 25**
- 9      Revision history ..... 26**



## List of tables

Table 1.	Pin description (SOT23-5L, SOT323-5L) . . . . .	6
Table 2.	Absolute maximum ratings . . . . .	8
Table 3.	Thermal data . . . . .	8
Table 4.	Electrical characteristics for LDK130 (fixed version). . . . .	9
Table 5.	Electrical characteristics for LDK130 (adjustable version) . . . . .	10
Table 6.	SOT23-5L package mechanical data . . . . .	18
Table 7.	DFN6 1.2 x 1.3 package mechanical data . . . . .	20
Table 8.	SOT323-5L mechanical data . . . . .	22
Table 9.	SOT23-5L tape and reel mechanical data . . . . .	24
Table 10.	SOT323-5L tape and reel mechanical data . . . . .	24
Table 11.	Order code . . . . .	25
Table 12.	Marking . . . . .	25
Table 13.	Document revision history . . . . .	26

## List of figures

Figure 1.	Block diagram . . . . .	5
Figure 2.	Pin connections (top view) . . . . .	6
Figure 3.	Typical application circuits for fixed version . . . . .	7
Figure 4.	Typical application circuits for adjustable version . . . . .	7
Figure 5.	Output voltage vs. temp. for adjustable ( $I_O = 1 \text{ mA}$ ) . . . . .	11
Figure 6.	Output voltage vs. temp. for adjustable version ( $I_O = 300 \text{ mA}$ ) . . . . .	11
Figure 7.	Output voltage vs. temp. for fixed version ( $I_O = 1 \text{ mA}$ ) . . . . .	11
Figure 8.	Output voltage vs. temp. for fixed version ( $I_O = 300 \text{ mA}$ ) . . . . .	11
Figure 9.	Line regulation vs. temp. for adjustable version . . . . .	12
Figure 10.	Short-circuit current vs. temp. for adjustable version . . . . .	12
Figure 11.	Load regulation vs. temp. for adjustable version . . . . .	12
Figure 12.	Load regulation vs. temp. for fixed version . . . . .	12
Figure 13.	Enable pin thresholds vs. temp. ( $V_{IN} = 1.9 \text{ V}$ ) . . . . .	12
Figure 14.	Enable pin thresholds vs. temp. . . . .	12
Figure 15.	Quiescent current vs. temp. for adjustable version ( $I_O = 0 \text{ mA}$ ) . . . . .	13
Figure 16.	Quiescent current vs. temp. for adjustable version ( $I_O = 300 \text{ mA}$ ) . . . . .	13
Figure 17.	Quiescent current vs. temp. for fixed version ( $I_O = 0 \text{ mA}$ ) . . . . .	13
Figure 18.	Quiescent current vs. temp. for fixed version ( $I_O = 300 \text{ mA}$ ) . . . . .	13
Figure 19.	Shutdown current vs. temperature . . . . .	13
Figure 20.	SVR vs. frequency ( $V_O = 2.5 \text{ V}$ ) . . . . .	13
Figure 21.	SVR vs. frequency ( $V_O = V_{ADJ}$ ) . . . . .	14
Figure 22.	Output noise vs. frequency ( $V_O = 3.3 \text{ V}$ ) . . . . .	14
Figure 23.	Output noise vs. frequency ( $V_O = V_{ADJ}$ ) . . . . .	14
Figure 24.	Stability region vs. $C_{OUT}$ (fixed) . . . . .	14
Figure 25.	Stability region vs $C_{OUT}$ (adjust.) . . . . .	14
Figure 26.	Line transient ( $V_{OUT} = V_{ADJ}$ ) . . . . .	14
Figure 27.	Line transient ( $V_{OUT} = 3 \text{ V}$ ) . . . . .	15
Figure 28.	Load transient ( $V_{OUT} = 3 \text{ V}$ ) . . . . .	15
Figure 29.	Load transient ( $V_{OUT} = V_{ADJ}$ ) . . . . .	15
Figure 30.	Startup transient . . . . .	15
Figure 31.	Enable transient ( $V_{OUT} = V_{ADJ}$ ) . . . . .	16
Figure 32.	Enable transient ( $V_{OUT} = 3 \text{ V}$ ) . . . . .	16
Figure 33.	Dropout voltage vs. temperature ( $I_{OUT} = 100 \text{ mA}$ ) . . . . .	16
Figure 34.	Dropout voltage vs. temperature ( $I_{OUT} = 300 \text{ mA}$ ) . . . . .	16
Figure 35.	SOT23-5L package outline . . . . .	17
Figure 36.	SOT23-5L footprint (dimensions in mm) . . . . .	18
Figure 37.	DFN6 1.2 x 1.3 package outline . . . . .	19
Figure 38.	DFN6 1.2 x 1.3 recommended footprint (dimensions in mm) . . . . .	20
Figure 39.	SOT323-5L package outline . . . . .	21
Figure 40.	SOT23-5L and SOT323-5L tape and reel outline . . . . .	23

# 1 Block diagram

Figure 1. Block diagram

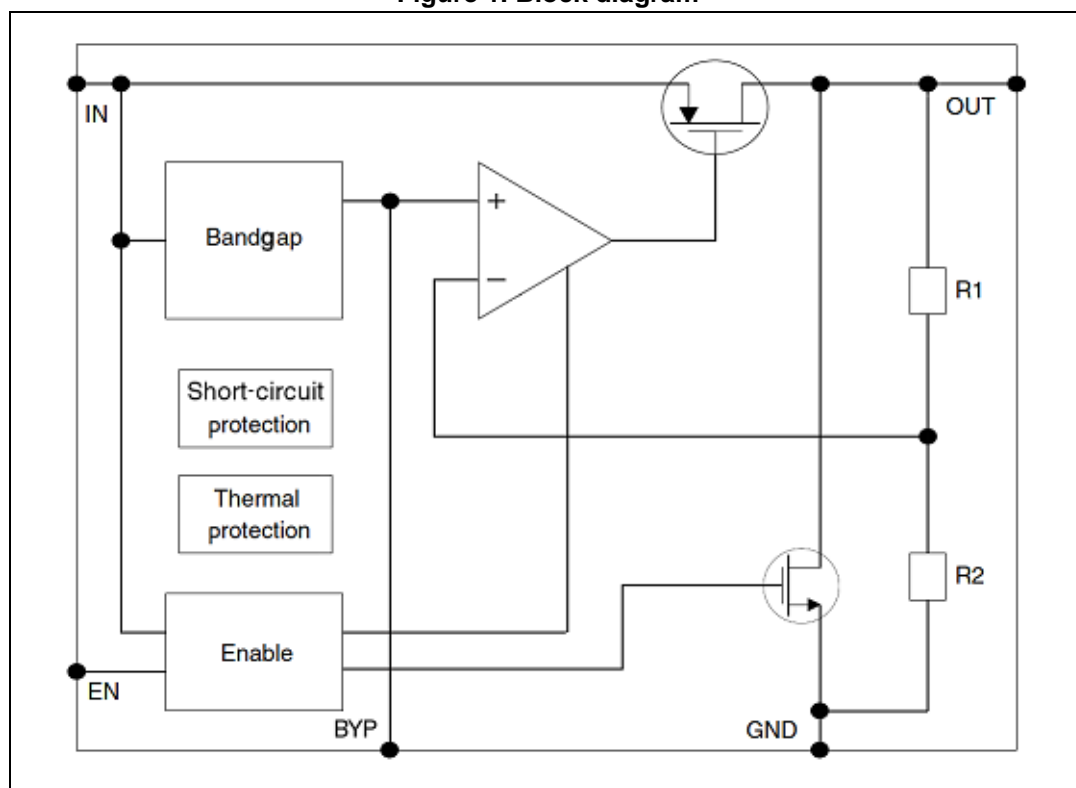

## 2 Pin configuration

Figure 2. Pin connections (top view)

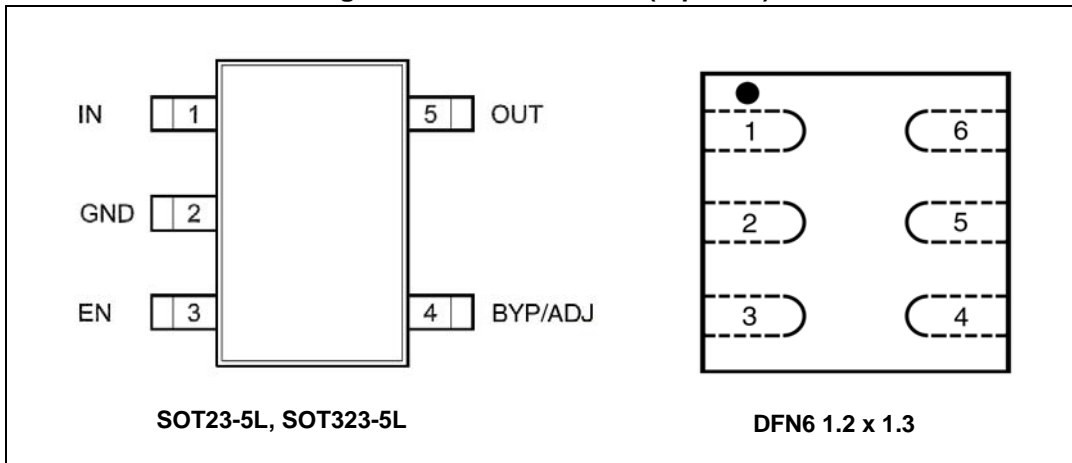

Table 1. Pin description (SOT23-5L, SOT323-5L)

Pin		Symbol	Function
SOT23/ SOT323	DFN6		
1	6	IN	Input voltage of the LDO
2	2	GND	Common ground
3	4	EN	Enable pin logic input: low = shutdown, high = active
4	3	BYP <sup>(1)</sup> /ADJ	Bypass capacitor on fixed versions, adjustable pin on ADJ versions
5	1	OUT	Output voltage of the LDO
-	5	N/C	Not connected. This pin should be connected to GND

1. Bypass capacitor for noise reduction on fixed version is optional, if not used the relevant pin must be left floating with no routing on the board.

### 3 Typical application

Figure 3. Typical application circuits for fixed version

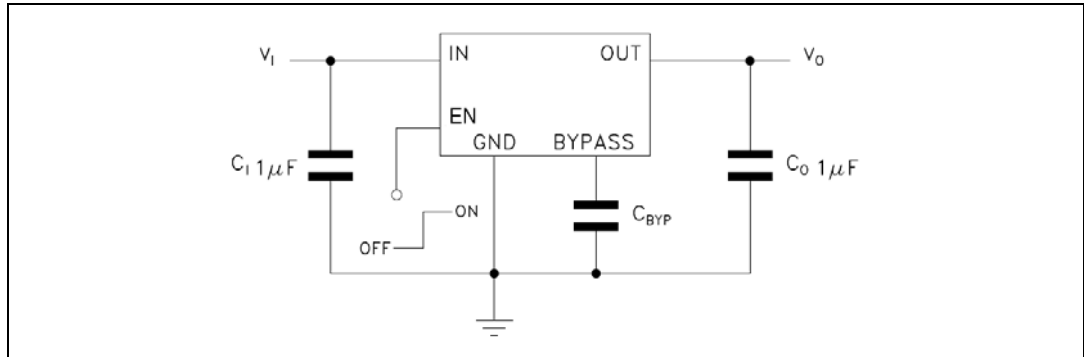
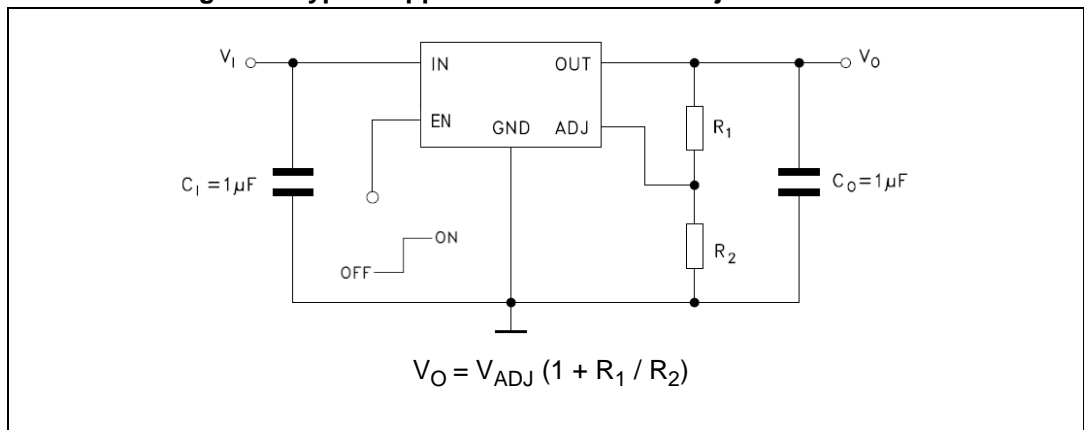

Figure 4. Typical application circuits for adjustable version



## 4 Maximum ratings

**Table 2. Absolute maximum ratings**

Symbol	Parameter	Value	Unit
$V_{IN}$	DC input voltage	- 0.3 to 7	V
$V_{OUT}$	DC output voltage	- 0.3 to $V_I + 0.3$	V
$V_{EN}$	Enable input voltage	- 0.3 to $V_I + 0.3$	V
$V_{BYP/ADJ}$	ADJ/bypass pin voltage	2	V
$I_{OUT}$	Output current	Internally limited	mA
$P_D$	Power dissipation	Internally limited	mW
$T_{STG}$	Storage temperature range	- 65 to 150	°C
$T_{OP}$	Operating junction temperature range	- 40 to 125	°C

*Note:* Absolute maximum ratings are those values beyond which damage to the device may occur. Functional operation under these conditions is not implied. All values are referred to GND.

**Table 3. Thermal data**

Symbol	Parameter	SOT23-5L	SOT323-5L	DFN6	Unit
$R_{thJA}$	Thermal resistance junction ambient	160	246	237	°C/W
$R_{thJC}$	Thermal resistance junction case	68	134	104	°C/W



## 5 Electrical characteristics

$T_J = 25\text{ °C}$ ,  $V_{IN} = V_{OUT(NOM)} + 1\text{ V}$ ,  $C_{IN} = C_{OUT} = 1\text{ }\mu\text{F}$ ,  $I_{OUT} = 1\text{ mA}$ ,  $V_{EN} = V_{IN}$ , unless otherwise specified.

**Table 4. Electrical characteristics for LDK130 (fixed version)**

Symbol	Parameter	Test conditions	Min.	Typ.	Max.	Unit
$V_{IN}$	Operating input voltage	-	1.9	-	5.5	V
$V_{OUT}$	$V_{OUT}$ accuracy	$I_{OUT} = 1\text{ mA}$ , $T_J = 25\text{ °C}$	-2.0	-	2.0	%
		$I_{OUT} = 1\text{ mA}$ , $-40\text{ °C} < T_J < 125\text{ °C}$	-3.0	-	3.0	%
$\Delta V_{OUT}$	Static line regulation	$V_{OUT} + 1\text{ V} \leq V_{IN} \leq 5.5\text{ V}$ , $I_{OUT} = 1\text{ mA}$	-	0.05	-	%/V
$\Delta V_{OUT}$	Static load regulation	$I_{OUT} = 1\text{ mA}$ to 300 mA	-	0.006	-	%/mA
$V_{DROP}$	Dropout voltage <sup>(1)</sup>	$I_{OUT} = 100\text{ mA}$ , $V_{OUT} = 2.5\text{ V}$	-	100	-	mV
		$I_{OUT} = 300\text{ mA}$ , $V_{OUT} = 2.5\text{ V}$ $40\text{ °C} < T_J < 125\text{ °C}$	-	200	400	
$e_N$	Output noise voltage	10 Hz to 100 kHz, $I_{OUT} = 10\text{ mA}$ , $V_{OUT} = 2.5\text{ V}$ , $C_{BYP} = 10\text{ nF}$	-	51	-	$\mu\text{V}_{RMS}/\text{V}$
SVR	Supply voltage rejection	$V_{IN} = V_{OUTNOM} + 0.5\text{ V} \pm V_{RIPPLE}$ $V_{RIPPLE} = 0.1\text{ V}$ freq. = 120 Hz to 10 kHz $I_{OUT} = 10\text{ mA}$	-	55	-	dB
$I_Q$	Quiescent current	$I_{OUT} = 0\text{ mA}$ , $-40\text{ °C} < T_J < 125\text{ °C}$	-	30	60	$\mu\text{A}$
		$I_{OUT} = 300\text{ mA}$ , $-40\text{ °C} < T_J < 125\text{ °C}$	-	70	120	
		$V_{IN}$ input current in OFF mode: $V_{EN} = \text{GND}$	-	-	1	
$I_{SC}$	Short-circuit current	$R_L = 0$	-	450	-	mA
$V_{EN}$	Enable input logic low	$V_{IN} = 1.9\text{ V}$ to $5.5\text{ V}$ , $-40\text{ °C} < T_J < 125\text{ °C}$	-	-	0.4	V
	Enable input logic high	$V_{IN} = 1.9\text{ V}$ to $5.5\text{ V}$ , $-40\text{ °C} < T_J < 125\text{ °C}$	1.2	-	-	
$I_{EN}$	Enable pin input current	$V_{SHDN} = V_{IN}$	-	-	100	nA
$T_{SHDN}$	Thermal shutdown	-	-	160	-	$^{\circ}\text{C}$
	Hysteresis	-	-	20	-	
$C_{OUT}$	Output capacitor	Capacitance (see <a href="#">Section 6: Typical performance characteristics</a> )	1	-	22	$\mu\text{F}$

1. Dropout voltage is the input-to-output voltage difference at which the output voltage is 100 mV below its nominal value.

$T_J = 25\text{ °C}$ ,  $V_{IN} = V_{OUT(NOM)} + 1\text{ V}$ ,  $C_{IN} = C_{OUT} = 1\text{ }\mu\text{F}$ ,  $I_{OUT} = 1\text{ mA}$ ,  $V_{EN} = V_{IN}$ , unless otherwise specified.

**Table 5. Electrical characteristics for LDK130 (adjustable version)**

Symbol	Parameter	Test conditions	Min.	Typ.	Max.	Unit
$V_{IN}$	Operating input voltage		1.9	-	5.5	V
$V_{ADJ}$	$V_{ADJ}$ accuracy	$I_{OUT} = 1\text{ mA}$ , $T_J = 25\text{ °C}$	784	800	816	mV
		$I_{OUT} = 1\text{ mA}$ , $-40\text{ °C} < T_J < 125\text{ °C}$	-3.0		3.0	%
$\Delta V_{OUT}$	Static line regulation	$V_{OUT} + 1\text{ V} \leq V_{IN} \leq 5.5\text{ V}$ , $I_{OUT} = 1\text{ mA}$	-	0.05	-	%/V
$\Delta V_{OUT}$	Static load regulation	$I_{OUT} = 1\text{ mA}$ to 300 mA	-	0.006	-	%/mA
$V_{DROP}$	Dropout voltage <sup>(1)</sup>	$I_{OUT} = 100\text{ mA}$ , $V_{OUT} = 2.5\text{ V}$	-	100	-	mV
		$I_{OUT} = 300\text{ mA}$ , $V_{OUT} = 2.5\text{ V}$ $40\text{ °C} < T_J < 125\text{ °C}$	-	200	400	
$e_N$	Output noise voltage	10 Hz to 100 kHz, $I_{OUT} = 10\text{ mA}$	-	130	-	$\mu\text{V}_{RMS}/\text{V}$
$I_{ADJ}$	Adjust pin current	-	-		1	$\mu\text{A}$
SVR	Supply voltage rejection	$V_{IN} = V_{OUTNOM} + 0.5\text{ V} \pm V_{RIPPLE}$ $V_{RIPPLE} = 0.1\text{ V}$ freq. = 120 Hz to 10 kHz $I_{OUT} = 10\text{ mA}$	-	55		dB
$I_Q$	Quiescent current	$I_{OUT} = 0\text{ mA}$ , $-40\text{ °C} < T_J < 125\text{ °C}$	-	30	60	$\mu\text{A}$
		$I_{OUT} = 300\text{ mA}$ , $-40\text{ °C} < T_J < 125\text{ °C}$	-	70	120	
		$V_{IN}$ input current in OFF mode: $V_{EN} = \text{GND}$	-	-	1	
$I_{SC}$	Short-circuit current	$R_L = 0$	-	450	-	mA
$V_{EN}$	Enable input logic low	$V_{IN} = 1.9\text{ V}$ to 5.5 V, $-40\text{ °C} < T_J < 125\text{ °C}$	-	-	0.4	V
	Enable input logic high	$V_{IN} = 1.9\text{ V}$ to 5.5 V, $-40\text{ °C} < T_J < 125\text{ °C}$	1.2	-	-	
$I_{EN}$	Enable pin input current	$V_{SHDN} = V_{IN}$	-		100	nA
$T_{SHDN}$	Thermal shutdown	-	-	160	-	$^{\circ}\text{C}$
	Hysteresis	-	-	20	-	
$C_{OUT}$	Output capacitor	Capacitance (see <a href="#">Section 6: Typical performance characteristics</a> )	1		22	$\mu\text{F}$

1. Dropout voltage is the input-to-output voltage difference at which the output voltage is 100 mV below its nominal value.



## 6 Typical performance characteristics

$C_{IN} = C_{OUT} = 1 \mu F$ ,  $V_{EN}$  to  $V_{IN}$ , unless otherwise specified.

**Figure 5. Output voltage vs. temp. for adjustable ( $I_O = 1 \text{ mA}$ )**

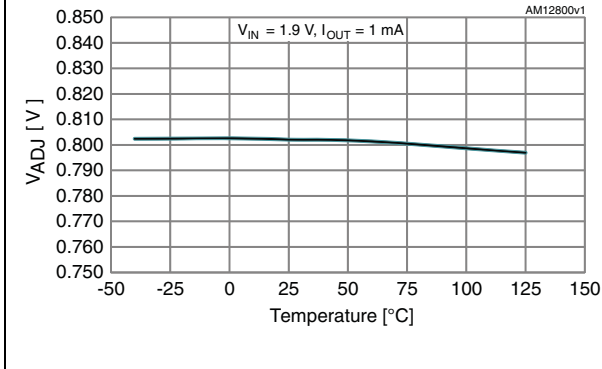

**Figure 6. Output voltage vs. temp. for adjustable version ( $I_O = 300 \text{ mA}$ )**

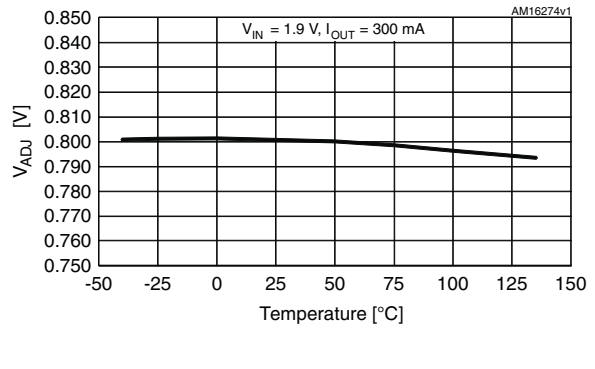

**Figure 7. Output voltage vs. temp. for fixed version ( $I_O = 1 \text{ mA}$ )**

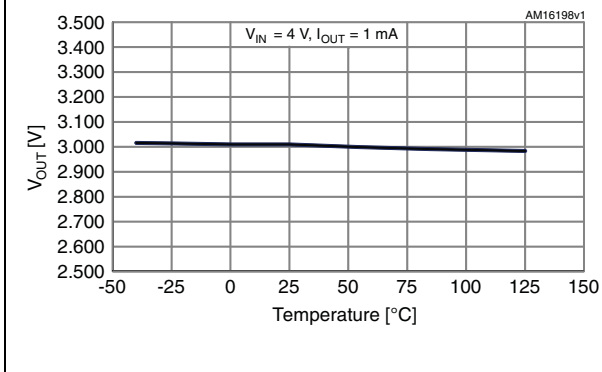

**Figure 8. Output voltage vs. temp. for fixed version ( $I_O = 300 \text{ mA}$ )**

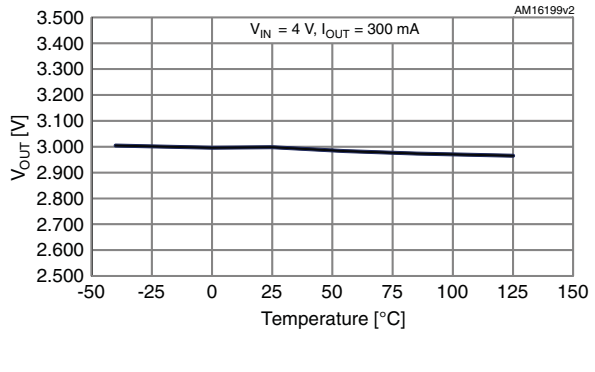

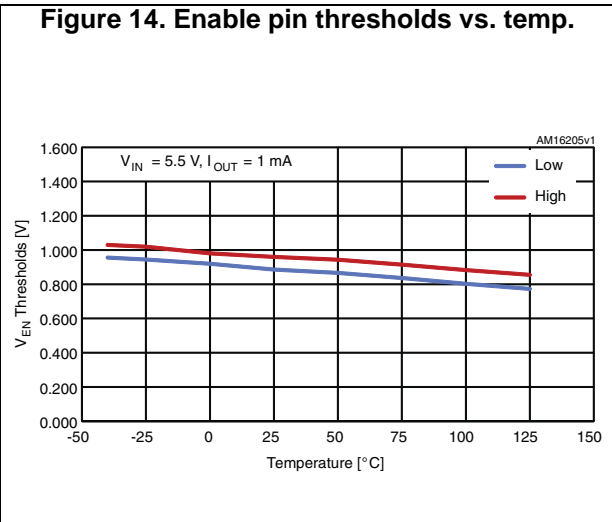
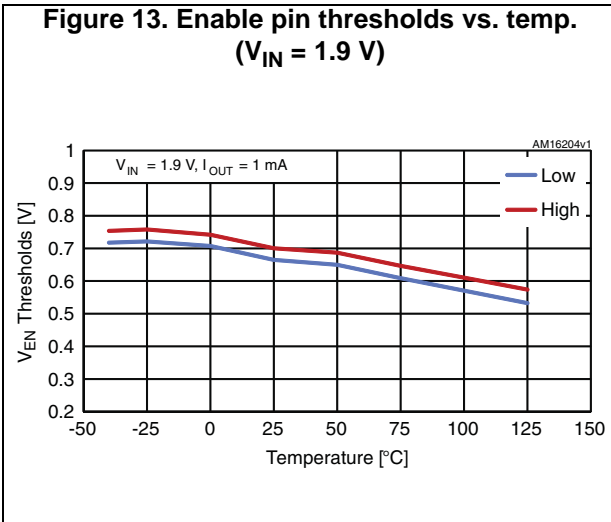
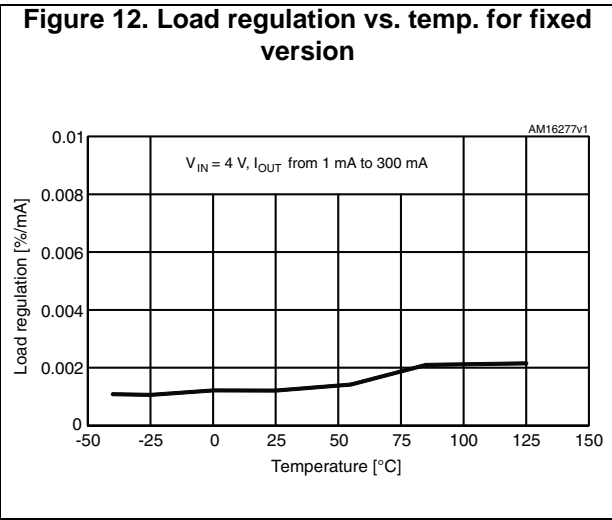
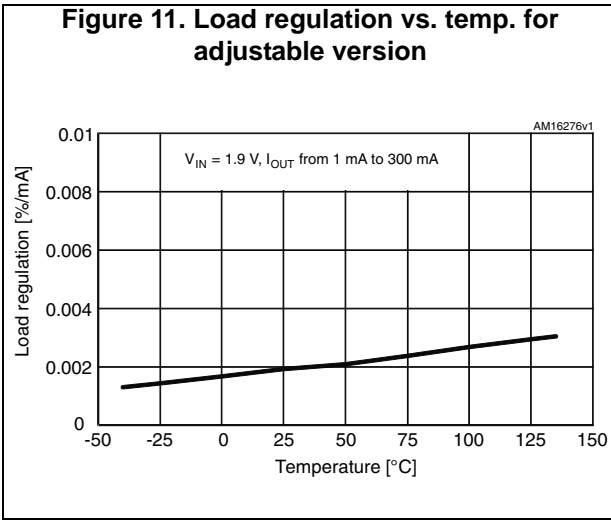
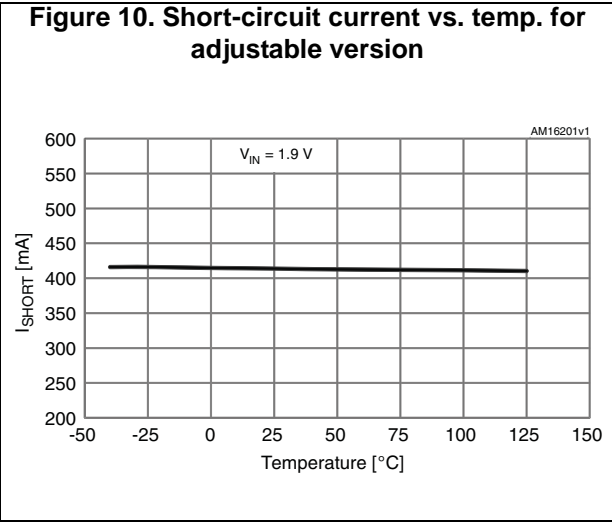
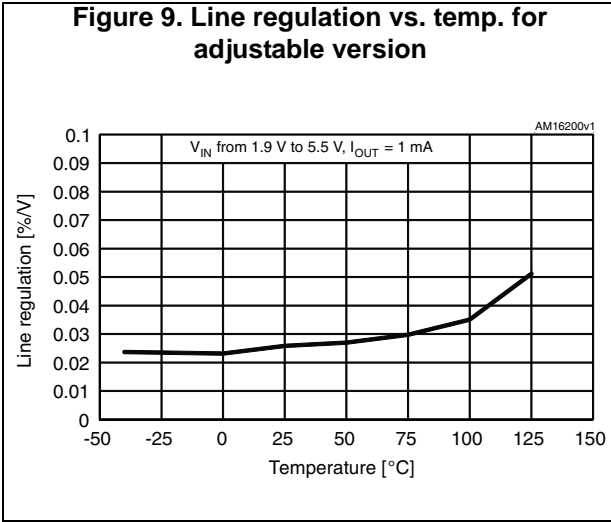

Figure 15. Quiescent current vs. temp. for adjustable version ( $I_O = 0$  mA)

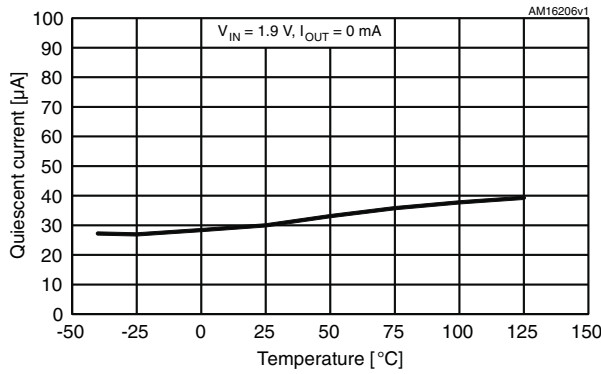

Figure 16. Quiescent current vs. temp. for adjustable version ( $I_O = 300$  mA)

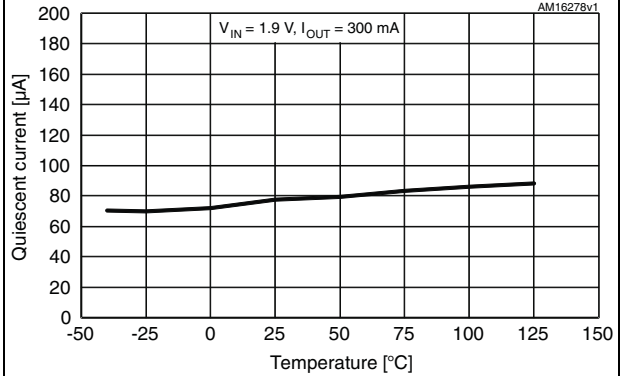

Figure 17. Quiescent current vs. temp. for fixed version ( $I_O = 0$  mA)

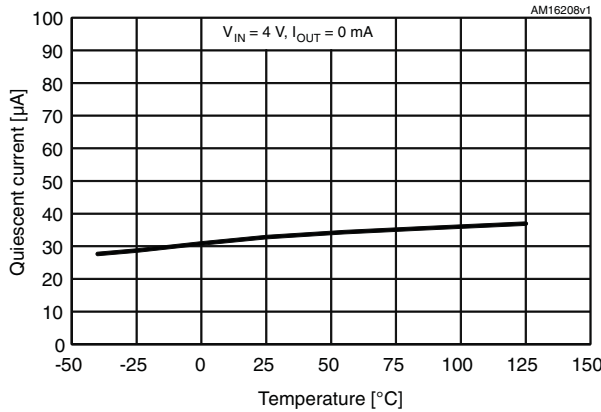

Figure 18. Quiescent current vs. temp. for fixed version ( $I_O = 300$  mA)

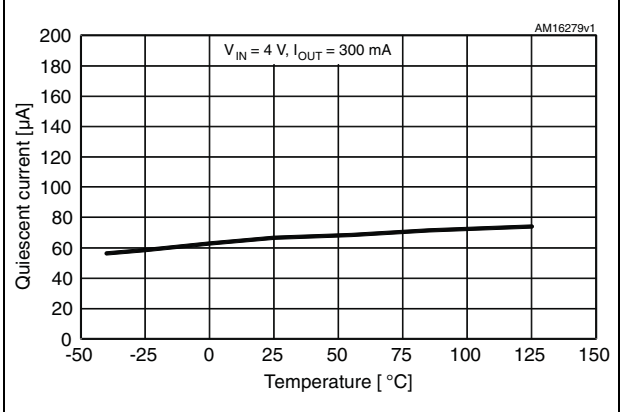

Figure 19. Shutdown current vs. temperature

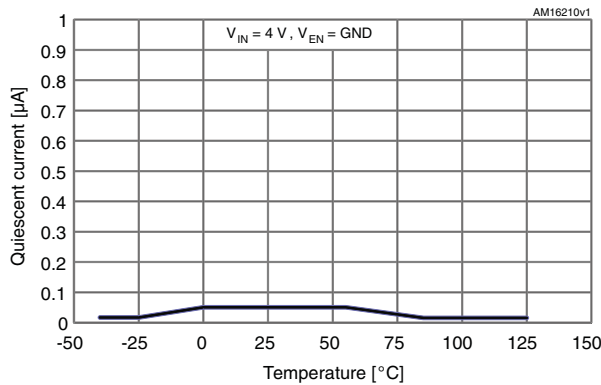
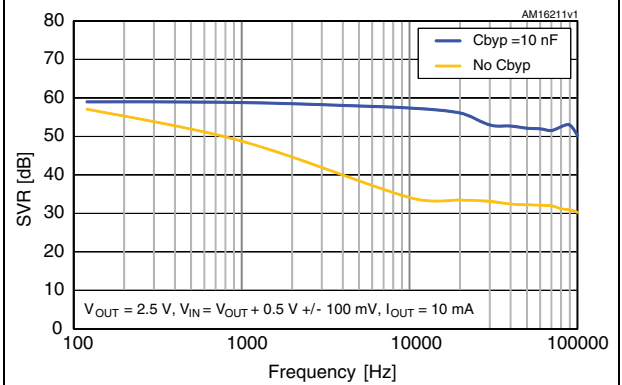

Figure 20. SVR vs. frequency ( $V_O = 2.5$  V)



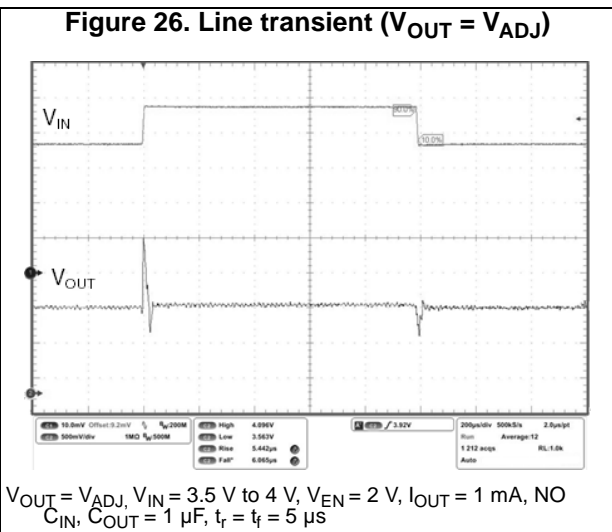
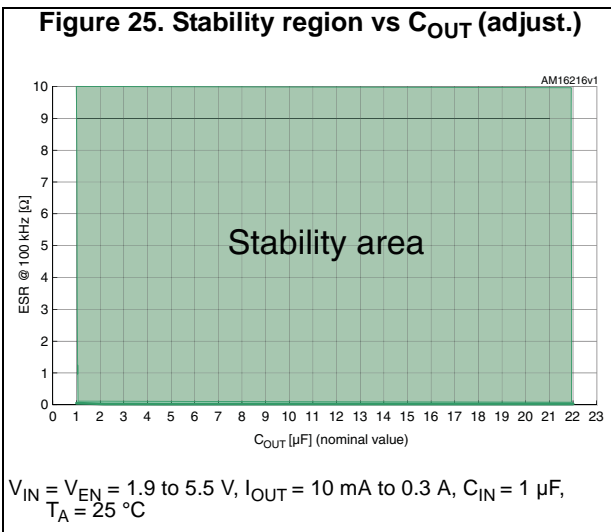
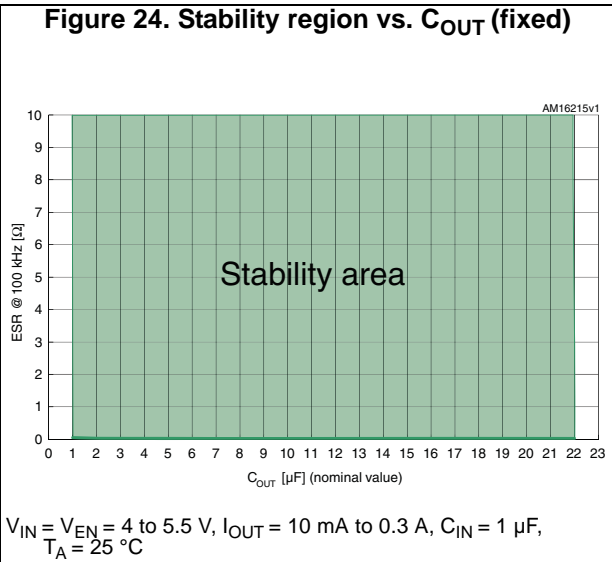
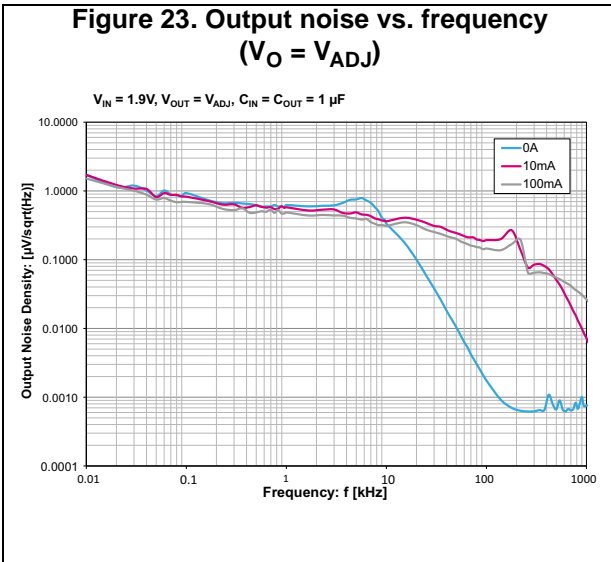
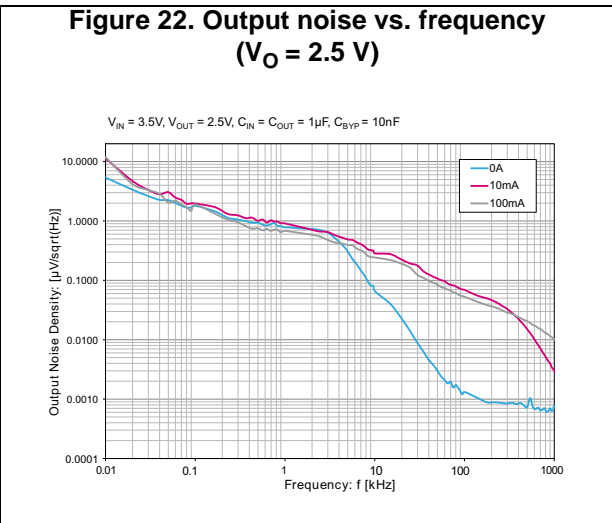
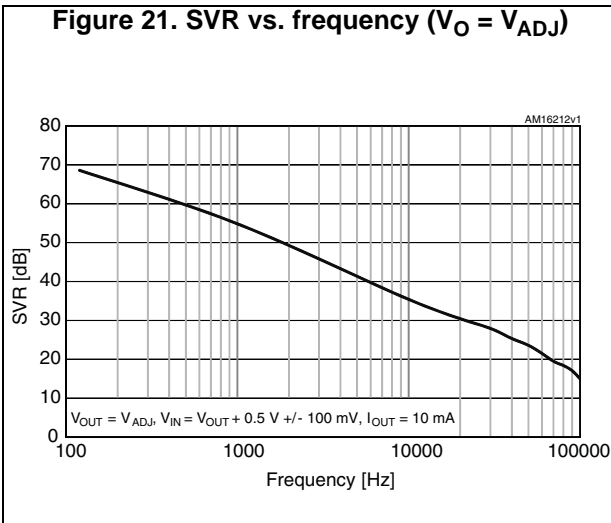
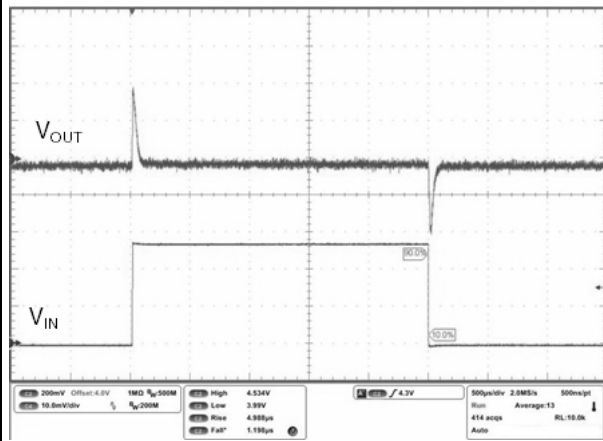
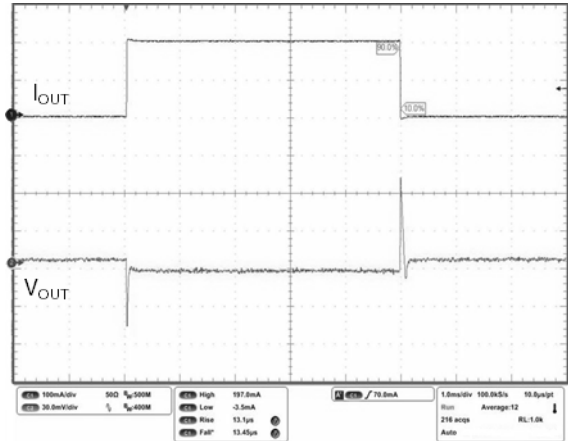

Figure 27. Line transient ( $V_{OUT} = 3\text{ V}$ )



$V_{OUT} = 3\text{ V}$ ,  $V_{IN} = 4\text{ V}$  to  $4.5\text{ V}$ ,  $V_{EN} = 2\text{ V}$ ,  $I_{OUT} = 1\text{ mA}$ , NO  $C_{IN}$ ,  $C_{OUT} = 1\text{ }\mu\text{F}$ ,  $t_r = t_f = 5\text{ }\mu\text{s}$

Figure 28. Load transient ( $V_{OUT} = 3\text{ V}$ )



$V_{OUT} = 3\text{ V}$ ,  $V_{IN} = V_{EN} = 3.5\text{ V}$ ,  $I_{OUT} = 1\text{ mA}$  to  $200\text{ mA}$ ,  $C_{OUT} = 1\text{ }\mu\text{F}$ ,  $t_r = t_f = 5\text{ }\mu\text{s}$

Figure 29. Load transient ( $V_{OUT} = V_{ADJ}$ )

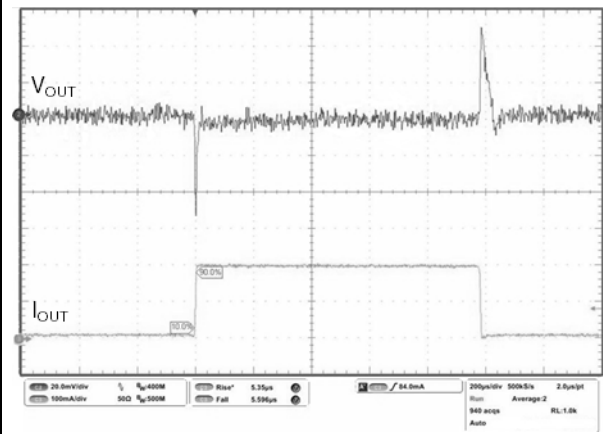

$V_{OUT} = V_{ADJ}$ ,  $V_{IN} = V_{EN} = 3.5\text{ V}$ ,  $I_{OUT} = 1\text{ mA}$  to  $200\text{ mA}$ ,  $C_{OUT} = 1\text{ }\mu\text{F}$ ,  $t_r = t_f = 5\text{ }\mu\text{s}$

Figure 30. Startup transient

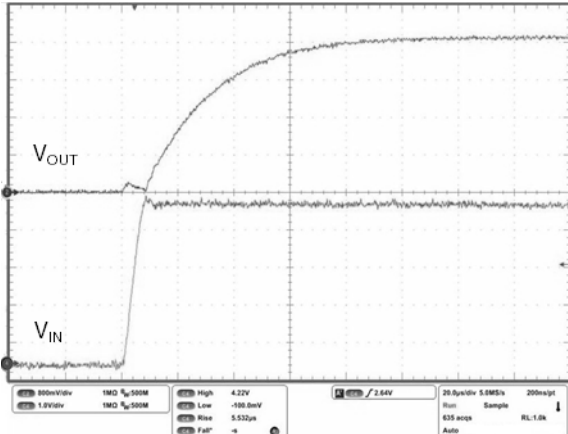

$V_{OUT} = 3\text{ V}$ ,  $V_{IN} = V_{EN} = 0$  to  $4.2\text{ V}$ ,  $I_{OUT} = 1\text{ mA}$ ,  $C_{IN} = C_{OUT} = 1\text{ }\mu\text{F}$ ,  $t_r = t_f = 5\text{ }\mu\text{s}$

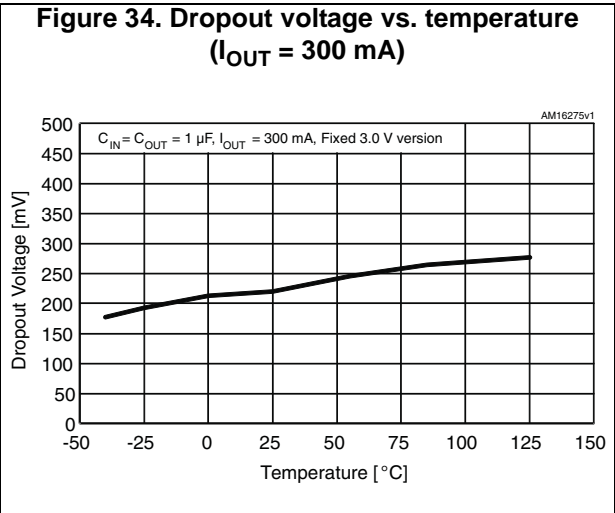
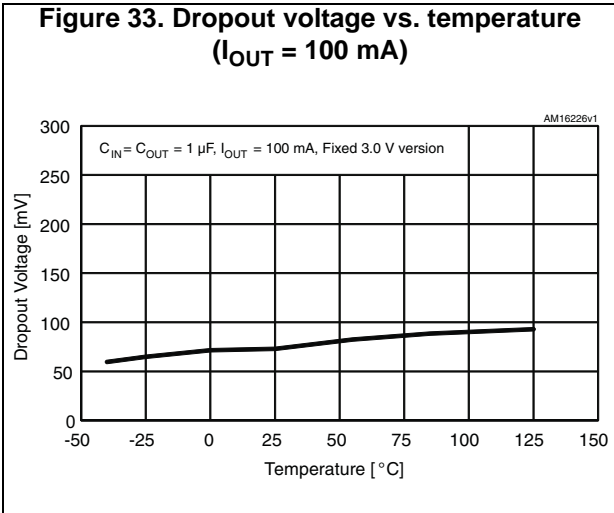
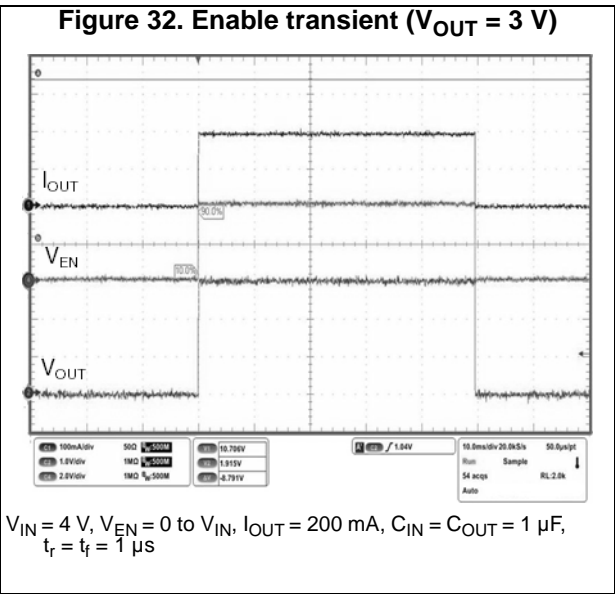
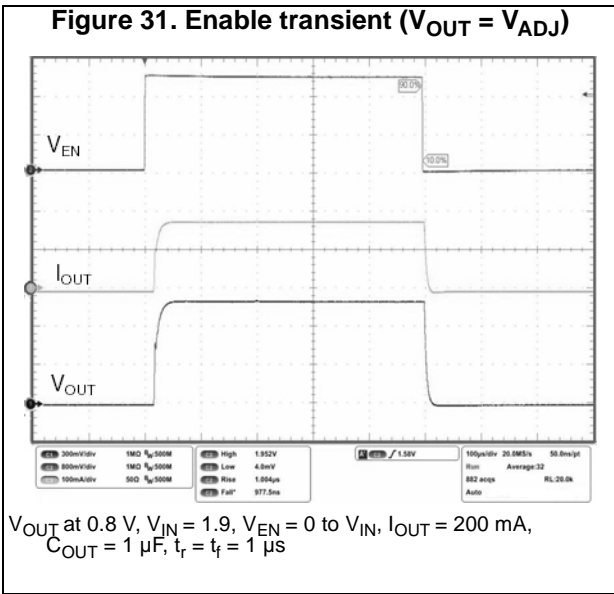



## 7 Package information

In order to meet environmental requirements, ST offers these devices in different grades of ECOPACK® packages, depending on their level of environmental compliance. ECOPACK specifications, grade definitions and product status are available at: [www.st.com](http://www.st.com). ECOPACK is an ST trademark.

### 7.1 SOT23-5L package information

Figure 35. SOT23-5L package outline

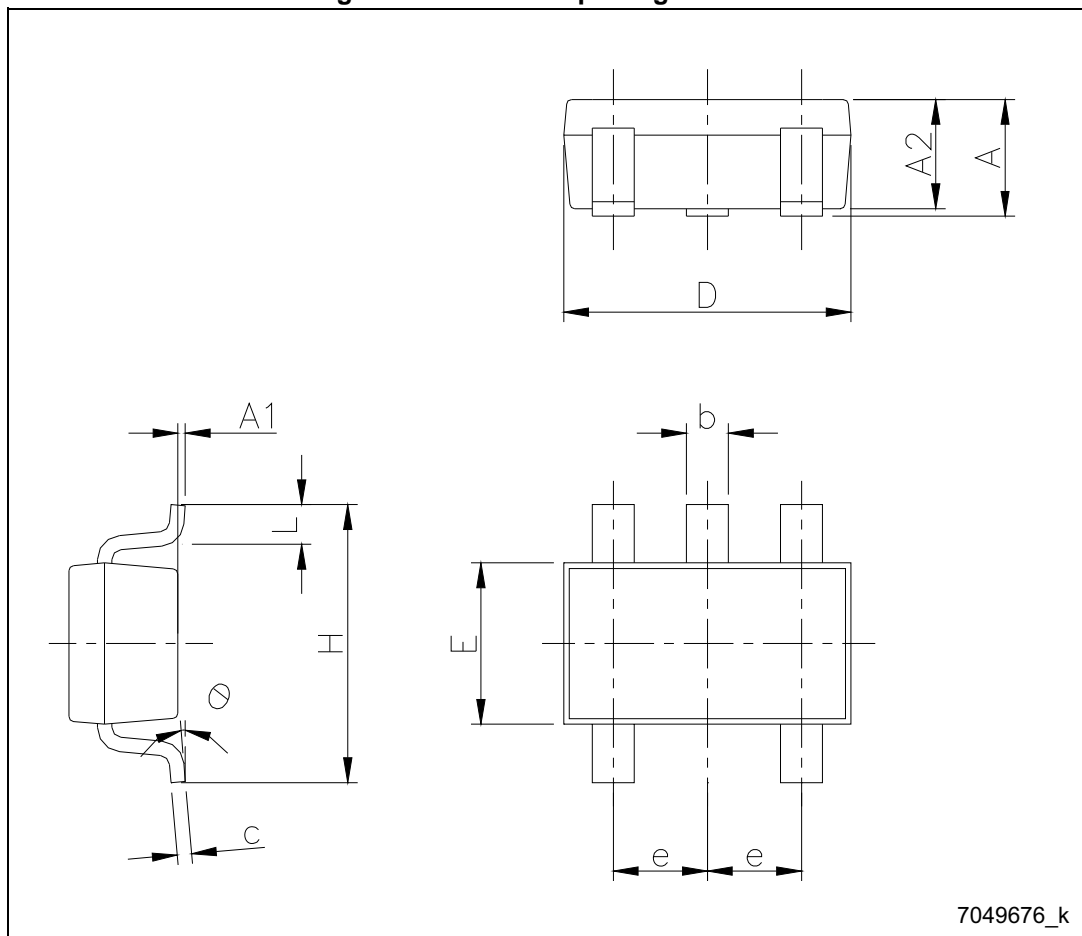
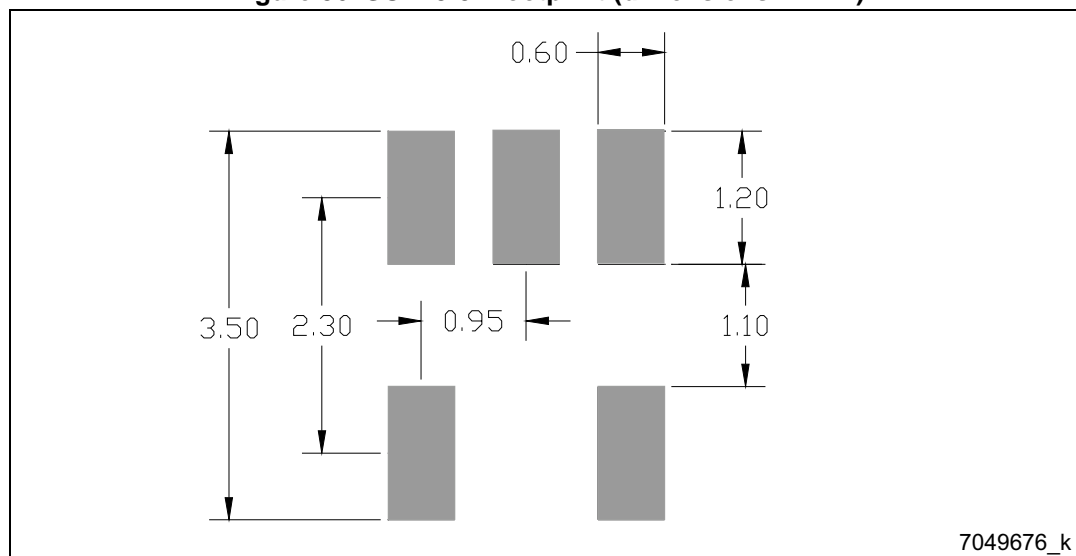

Table 6. SOT23-5L package mechanical data

Symbol	Dimensions (mm)		
	Min.	Typ.	Max.
A	0.90	-	1.45
A1	0	-	0.15
A2	0.90	-	1.30
b	0.30	-	0.50
c	2.09	-	0.20
D	-	2.95	-
E	-	1.60	-
e	-	0.95	-
H	-	2.80	-
L	0.30	-	0.60
$\theta$	0	-	8

Figure 36. SOT23-5L footprint (dimensions in mm)



## 7.2 DFN6 1.2 x 1.3 package information

Figure 37. DFN6 1.2 x 1.3 package outline

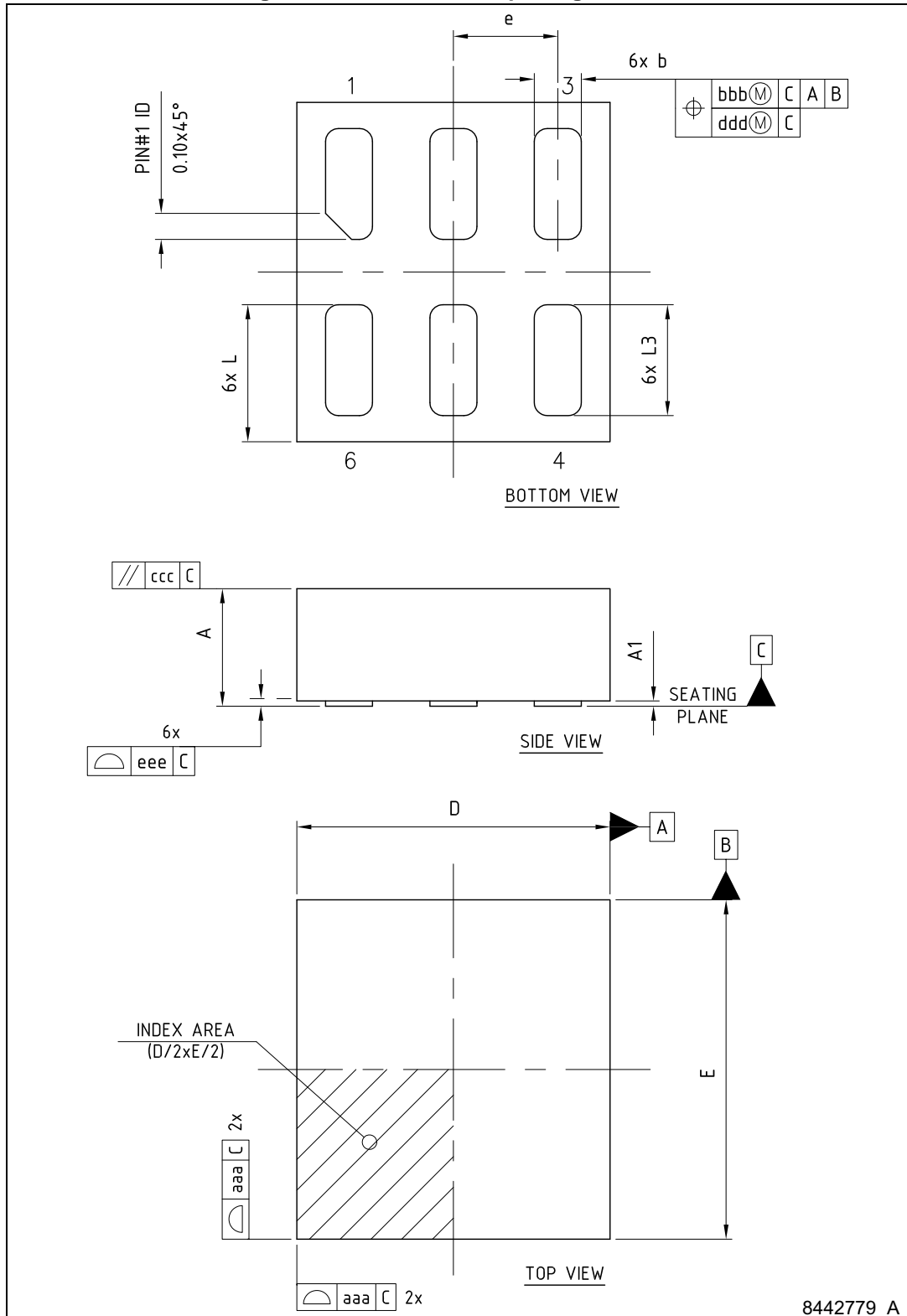

8442779 A

Table 7. DFN6 1.2 x 1.3 package mechanical data

Symbol	Dimensions (mm)		
	Min.	Typ.	Max.
A	0.41	0.45	0.50
A1	0.00	0.02	0.05
D	-	1.20	-
E	-	1.30	-
e	-	0.40	-
b	0.15	0.18	0.25
L	0.475	0.525	0.575
L3	0.375	0.425	0.475
aaa	-	0.05	-

Figure 38. DFN6 1.2 x 1.3 recommended footprint (dimensions in mm)

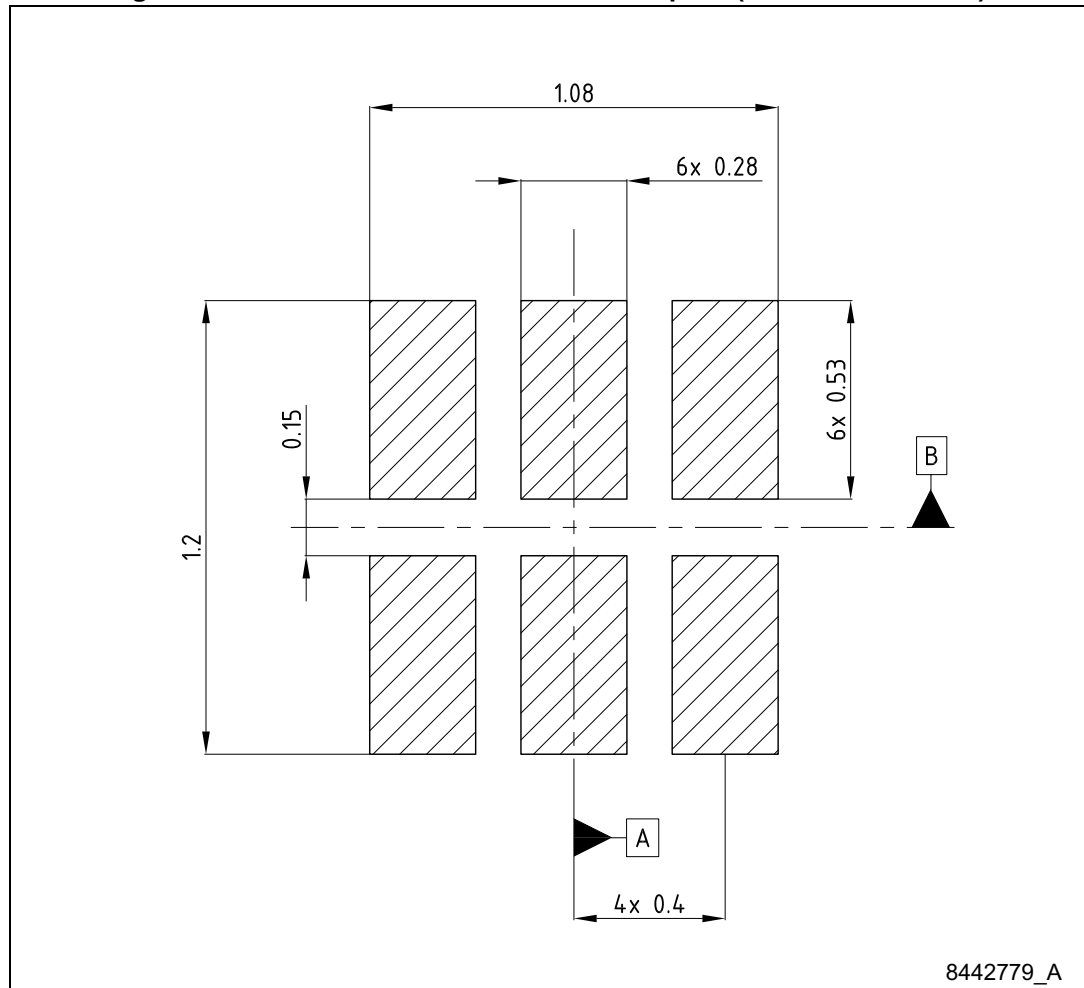

8442779\_A

### 7.3 SOT323-5L package information

Figure 39. SOT323-5L package outline

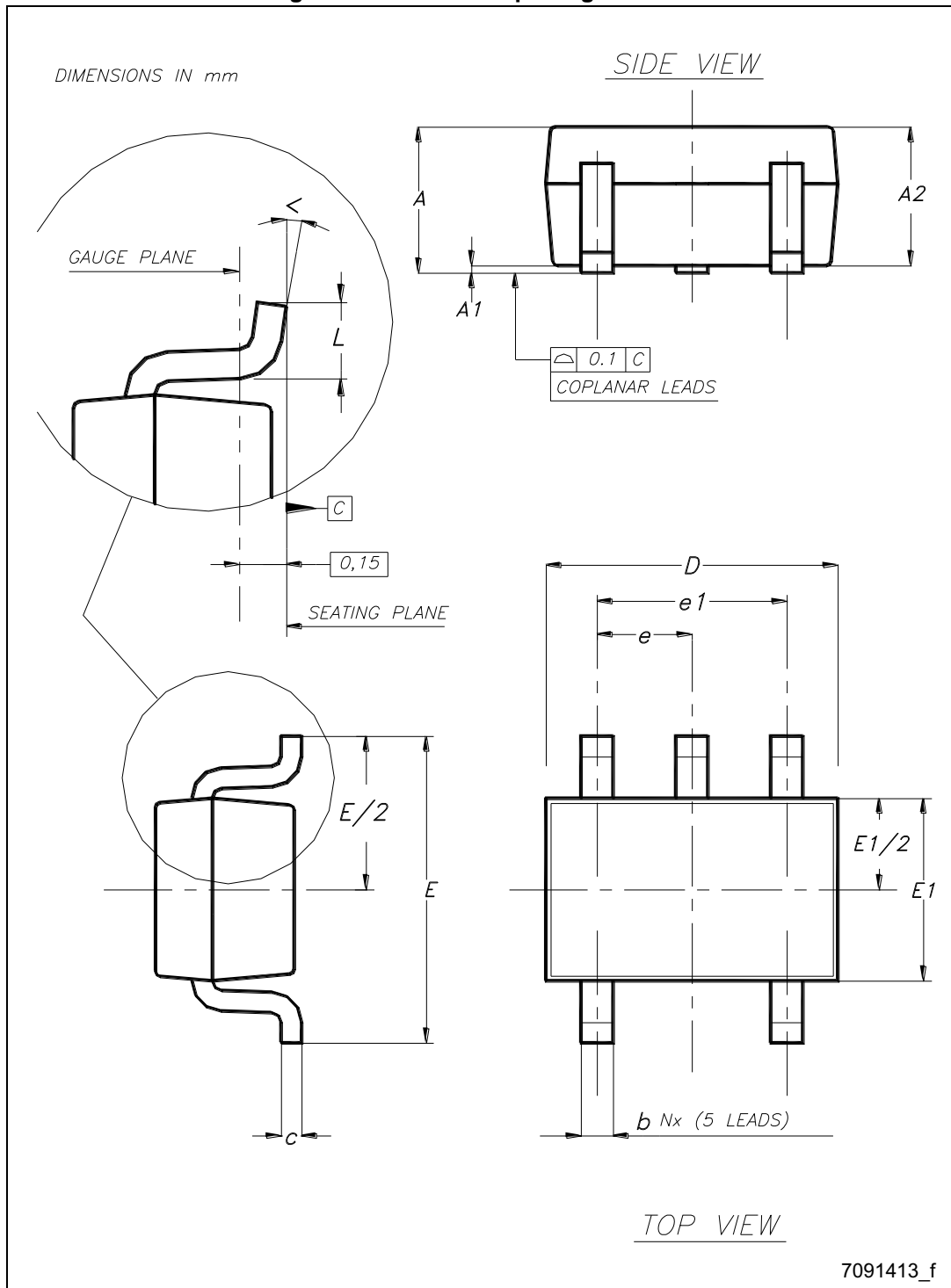

Table 8. SOT323-5L mechanical data

Symbol	Dimensions (mm)		
	Min.	Typ.	Max.
A	0.80	-	1.10
A1	0	-	0.10
A2	0.80	0.90	1
b	0.15	-	0.30
c	0.10	-	0.22
D	1.80	2	2.20
E	1.80	2.10	2.40
E1	1.15	1.25	1.35
e	-	0.65	-
e1	-	1.30	-
L	0.26	0.36	0.46
<	0°	-	8°

7.4 Packing information

7.5 SOT23-5L and SOT323-5L packing information

Figure 40. SOT23-5L and SOT323-5L tape and reel outline

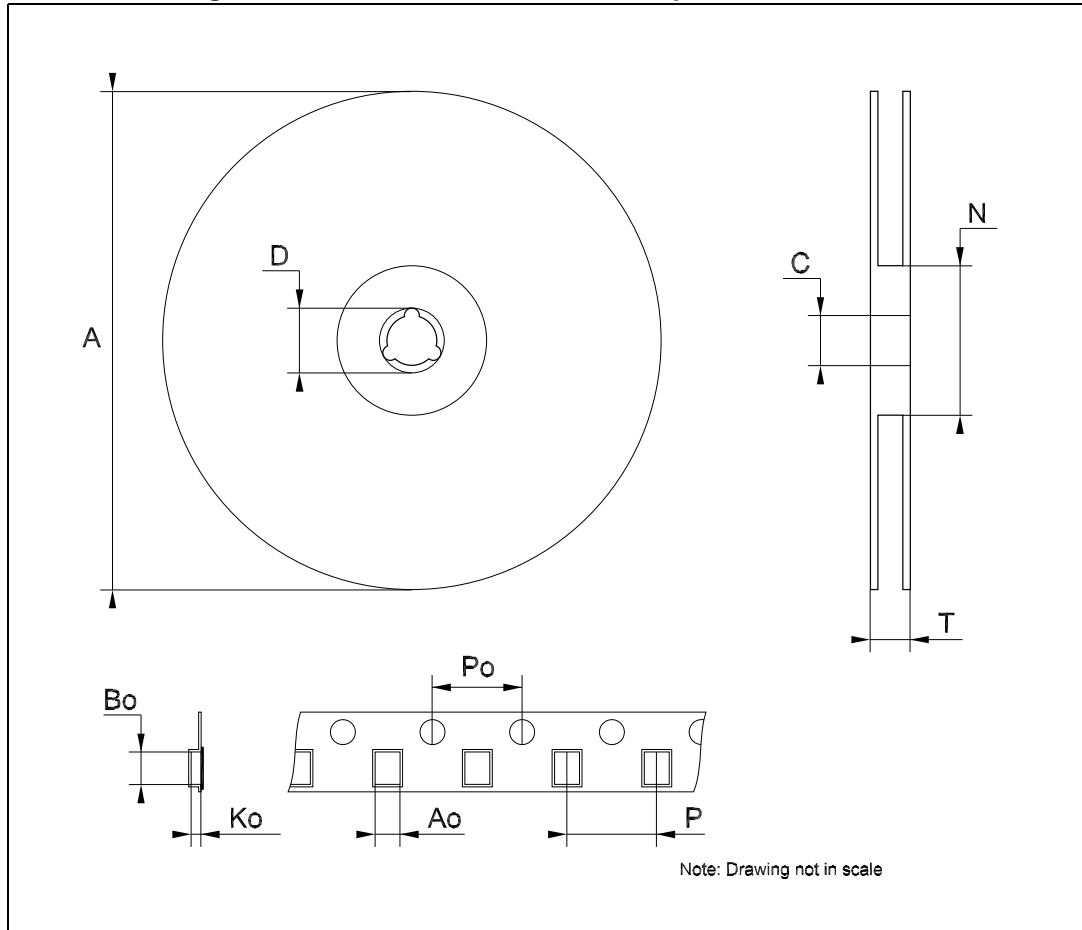

Table 9. SOT23-5L tape and reel mechanical data

Symbol	Dimensions (mm)		
	Min.	Typ.	Max.
A	-	-	180
C	12.8	13.0	13.2
D	20.2	-	-
N	60	-	-
T	-	-	14.4
Ao	3.13	3.23	3.33
Bo	3.07	3.17	3.27
Ko	1.27	1.37	1.47
Po	3.9	4.0	4.1
P	3.9	4.0	4.1

Table 10. SOT323-5L tape and reel mechanical data

Symbol	Dimensions (mm)		
	Min.	Typ.	Max.
A	175	180	185
C	12.8	13	13.2
D	20.2	-	-
N	59.5	60	60.5
T	-	-	14.4
Ao	-	2.25	-
Bo	-	3.17	-
Ko	-	1.2	-
Po	3.9	4.0	4.1
P	3.9	4.0	4.2



## 8 Order code

Table 11. Order code

Packages				Output voltages
SOT323-5L	SOT23-5L	SOT23-5L <sup>(1)</sup>	DFN6L	
LDK130C-R	LDK130M-R	-	LDK130PU-R	ADJ
LDK130C08R	LDK130M08R	-	LDK130PU08R	0.8 V
LDK130C10R	LDK130M10R	-	LDK130PU10R	1 V
LDK130C12R	LDK130M12R	-	LDK130PU12R	1.2 V
LDK130C15R	LDK130M15R	LDK130M15RY	LDK130PU15R	1.5 V
LDK130C18R	LDK130M18R	LDK130M18RY	LDK130PU18R	1.8 V
-	LDK130M25R	-	LDK130PU25R	2.5 V
-	-	LDK130M28RY	-	2.8 V
LDK130C29R	LDK130M29R	-	LDK130PU29R	2.9 V
-	-	-	LDK130PU30R	3 V
LDK130C32R	LDK130M32R	-	LDK130PU32R	3.2 V
LDK130C33R	LDK130M33R	LDK130M33RY	LDK130PU33R	3.3 V

1. Automotive grade according to AEC-Q100 level 1.

Table 12. Marking

Order code	Package	Output voltage	Marking
LDK130MxxR	SOT23-5L	x.x V	Kxx
LDK130CxxR	SOT323-5L	x.x V	Kxx
LDK130PUxxR	DFN-6L	x.x V	xx
LDK130M-R	SOT23-5L	Adj	KAD
LDK130C-R	SOT323-5L	Adj	KAD
LDK130PU-R	DFN-6L	Adj	AD
LDK130MxxRY	SOT23-5L	x.x V	KxxY

## 9 Revision history

**Table 13. Document revision history**

Date	Revision	Changes
31-Jan-2013	1	Initial release
25-Oct-2013	2	RPN LDK130xx changed to LDK130. Updated the Features and the Description in cover page. Canceled Table1: Device summary. Updated <i>Section 7: Package mechanical data</i> , <i>Table 2: Absolute maximum ratings</i> and <i>Table 11: Order codes</i> . Added <i>Section 8: Packaging mechanical data</i> . Minor text changes.
10-Mar-2014	3	Updated <i>Table 11: Order codes</i> .
07-Sep-2017	4	Updated main title <i>on page 1</i> , <i>Section : Features on page 1</i> , <i>Table 11 on page 25</i> and <i>Table 12 on page 25</i> (added "automotive grade level 1" - AEC-Q100 qualified). Updated <i>Features</i> (replaced "max. 120 $\mu$ A" by "typ. 30 $\mu$ A"). Updated <i>Section : Applications on page 1</i> . Minor modifications throughout document.
26-Oct-2017	5	Updated LDK130M28RY in <i>Table 11: Order codes</i>
17-Jan-2018	6	Updated <a href="#">Figure 22</a> and <a href="#">Figure 23</a> .

**IMPORTANT NOTICE – PLEASE READ CAREFULLY**

STMicroelectronics NV and its subsidiaries ("ST") reserve the right to make changes, corrections, enhancements, modifications, and improvements to ST products and/or to this document at any time without notice. Purchasers should obtain the latest relevant information on ST products before placing orders. ST products are sold pursuant to ST's terms and conditions of sale in place at the time of order acknowledgement.

Purchasers are solely responsible for the choice, selection, and use of ST products and ST assumes no liability for application assistance or the design of Purchasers' products.

No license, express or implied, to any intellectual property right is granted by ST herein.

Resale of ST products with provisions different from the information set forth herein shall void any warranty granted by ST for such product.

ST and the ST logo are trademarks of ST. All other product or service names are the property of their respective owners.

Information in this document supersedes and replaces information previously supplied in any prior versions of this document.

© 2018 STMicroelectronics – All rights reserved

# Mouser Electronics

Authorized Distributor

Click to View Pricing, Inventory, Delivery & Lifecycle Information:

## STMicroelectronics:

[LDK130C12R](#) [LDK130C18R](#) [LDK130C33R](#) [LDK130M33R](#) [LDK130M-R](#) [LDK130C-R](#) [LDK130M25R](#) [LDK130M32R](#)  
[LDK130C32R](#) [LDK130M18R](#) [LDK130M12R](#) [LDK130C10R](#) [LDK130PU32R](#) [LDK130M08R](#) [LDK130PU08R](#)  
[LDK130M15R](#) [LDK130PU-R](#) [LDK130M29R](#) [LDK130C15R](#) [LDK130M10R](#) [LDK130PU29R](#) [LDK130C08R](#)  
[LDK130PU15R](#) [LDK130C29R](#) [LDK130PU30R](#) [LDK130PU12R](#) [LDK130PU10R](#) [LDK130PU25R](#) [LDK130PU33R](#)  
[LDK130PU18R](#) [LDK130M28RY](#) [LDK130M15RY](#) [LDK130M18RY](#) [LDK130M33RY](#)