

# Wire Wound Inductors (Ferrite Base)

AISC-1210HS

MSL level: 2 (This part is packed with dry packaging)



RoHS  
Compliant

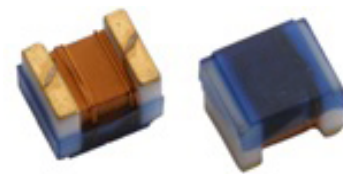

3.20 x 3.05 x 1.30 mm

## FEATURES:

- Excellent solderability and resistance soldering heat.
- Suitable for RoHS compliant reflow.
- High reliability and suitable for surface mount assembly.
- Wide range of inductance value are available.
- Small in tolerance from  $\pm 10\%$ .

## APPLICATIONS:

- Notebooks, PC's,
- Cellular phone backlight, Inverter and etc.

## ELECTRICAL SPECIFICATIONS:

### PARAMETERS

ABRACON P/N:	AISC-01210HS Series
Operating temperature:	-40°C to +85°C
Storage temperature:	-10°C to +40°C, 20% to 70% RH

Abracon Part Number	L ( $\mu$ H)	Tolerance (K. M)	Q Min	L, Q Test Freq (kHz/MHz)	SRF Min (MHz)	DCR Max ( $\Omega$ )	I <sub>SAT</sub> Max (mA)	I <sub>DC</sub> Max (mA)
AISC-1210HS-2R2	2.2	K. M	10	100 / 1	150	0.5	850	800
AISC-1210HS-2R7	2.7	K. M	10	100 / 1	120	0.6	750	700
AISC-1210HS-3R3	3.3	K. M	10	100 / 1	100	0.75	700	650
AISC-1210HS-3R9	3.9	K. M	10	100 / 1	90	0.8	650	600
AISC-1210HS-4R7	4.7	K. M	10	100 / 1	80	0.95	600	550
AISC-1210HS-5R6	5.6	K. M	10	100 / 1	65	1	550	520
AISC-1210HS-6R8	6.8	K. M	10	100 / 1	55	1.1	500	480
AISC-1210HS-8R2	8.2	K. M	10	100 / 1	40	1.3	480	450
AISC-1210HS-100	10	K. M	10	100 / 1	36	1.5	450	430
AISC-1210HS-120	12	K. M	10	100 / 1	34	1.6	420	400
AISC-1210HS-150	15	K. M	10	100 / 1	32	1.9	400	350
AISC-1210HS-180	18	K. M	10	100 / 1	30	2.9	350	320
AISC-1210HS-220	22	K. M	10	100 / 1	30	3.5	320	300
AISC-1210HS-270	27	K. M	10	100 / 1	25	4.2	280	250
AISC-1210HS-330	33	K. M	10	100 / 1	20	5	250	220

### Test Equipment:

1. Inductance is measured in HP-4284A precision LCR meter with SMD-A fixture.
2. Q factor is measured in HP-4284A precision LCR meter with SMD-A fixture.
3. SRF is measured in Agilent E-5071B Network Analyzer.
4. RDC is measured in HP-4338B milliohm meter.
5. I<sub>sat</sub>: Based on inductance change ( $\Delta L/L_0 : \leq -10\%$ )
6. I<sub>DC</sub>: Based on temperature rise ( $\Delta T : 25^\circ\text{C TYP.}$ )

Unless otherwise specified, the standard range of atmospheric condition for making measurement and test are as follows:

Ambient Temperature : 25°C (20°C)  $\pm$  2°C

Relative Humidity : 60% to 70%

Air Pressure : 86Kpa to 106Kpa

ABRACON IS  
ISO 9001:2008  
CERTIFIED

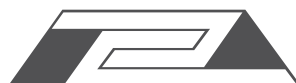

**ABRACON**  
CORPORATION

Visit [www.abracon.com](http://www.abracon.com) for Terms & Conditions of Sale

30332 Esperanza, Rancho Santa Margarita, California 92688  
tel 949-546-8000 fax 949-546-8001 [www.abracon.com](http://www.abracon.com)

Revised: 12.08.11

# Wire Wound Inductors (Ferrite Base)

AISC-1210HS



RoHS  
Compliant

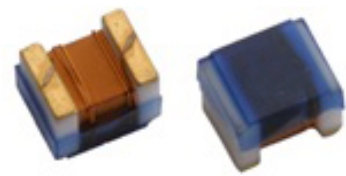

3.20 x 3.05 x 1.30 mm

## ELECTRICAL CHARACTERISTICS

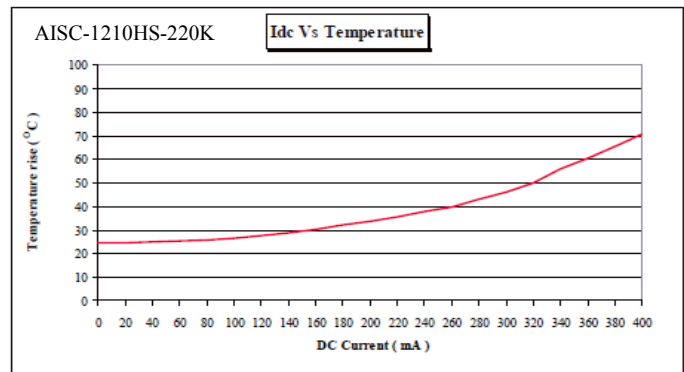
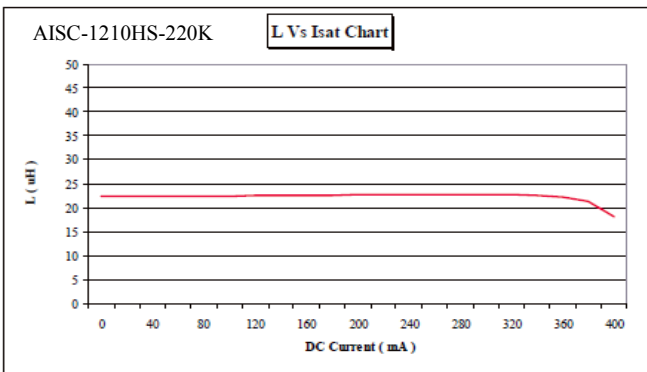
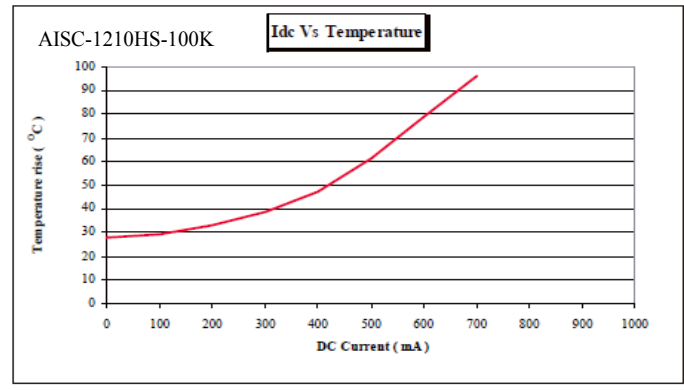
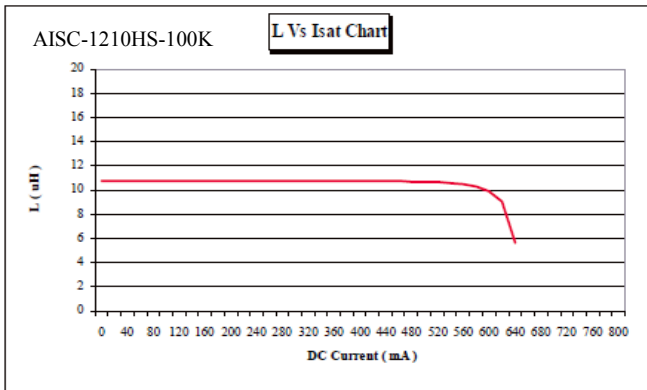
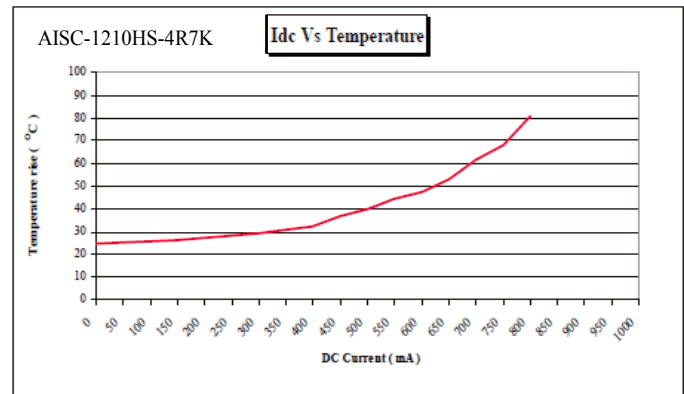
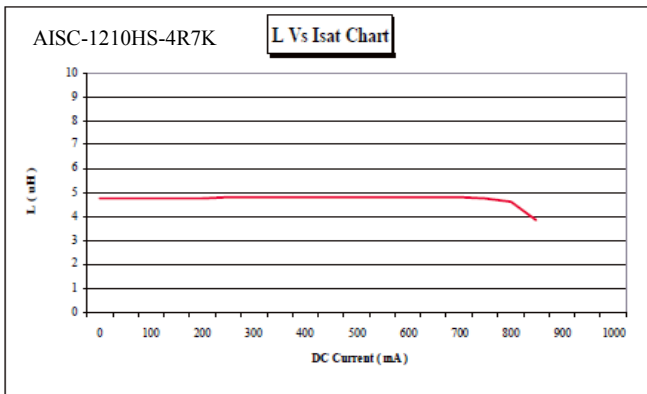
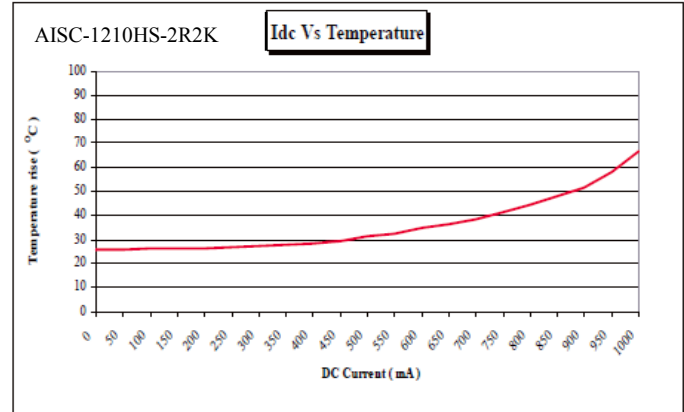
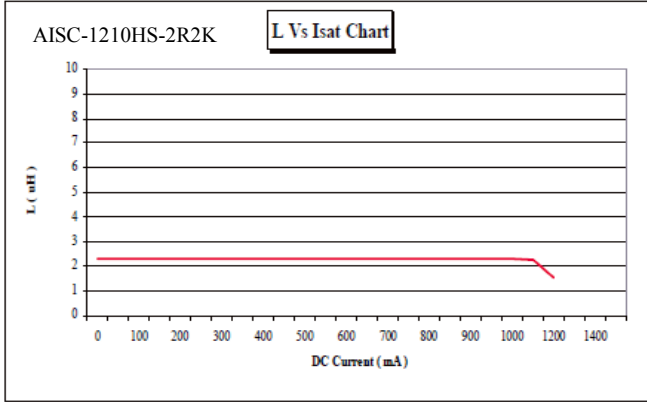

# Wire Wound Inductors (Ferrite Base)

AISC-1210HS



RoHS  
Compliant

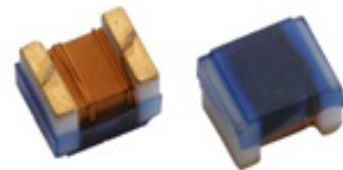

3.20 x 3.05 x 1.30 mm

## PART NUMBER IDENTIFICATION

AISC-1210HS-  -

Inductance Code
Please refer to the table

Tolerance Code
K: ±10%
M: ±20%

Packaging
T2: Tape & Reel (2k pcs/Reel)

## OUTLINE DIMENSIONS

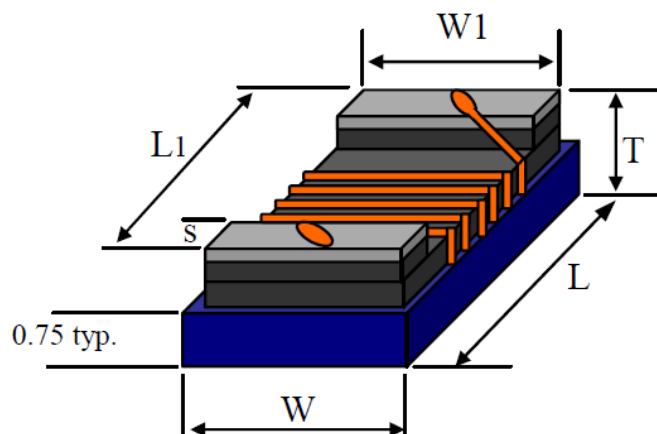

L	L1	W	W1	T	s
3.20±0.30 [0.126±0.012]	3.05±0.10 [0.12±0.004]	2.50±0.30 [0.098±0.012]	2.40±0.10 [0.094±0.004]	1.30 Max. [0.051 Max.]	0.50±0.10 [0.02±0.004]

### Recommended Land Pattern

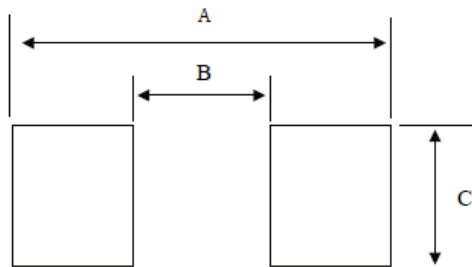

A	B	C
4.00	1.70	2.82

Dimension: mm [inch]

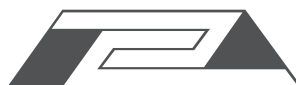

# Wire Wound Inductors (Ferrite Base)

AISC-1210HS



RoHS  
Compliant

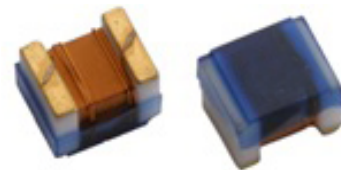

3.20 x 3.05 x 1.30 mm

## REFLOW PROFILE

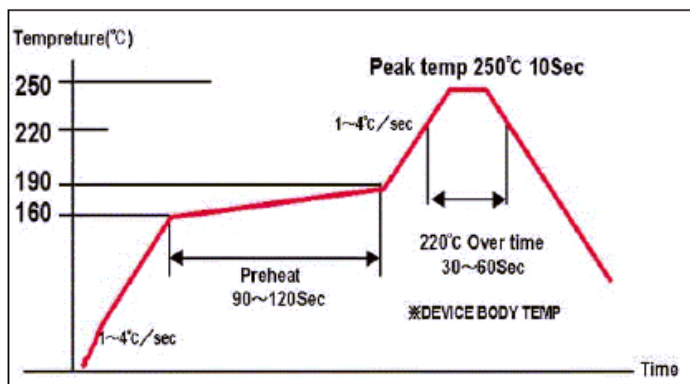

## TAPE & REEL: T2= tape and reel (2,000pcs/reel)

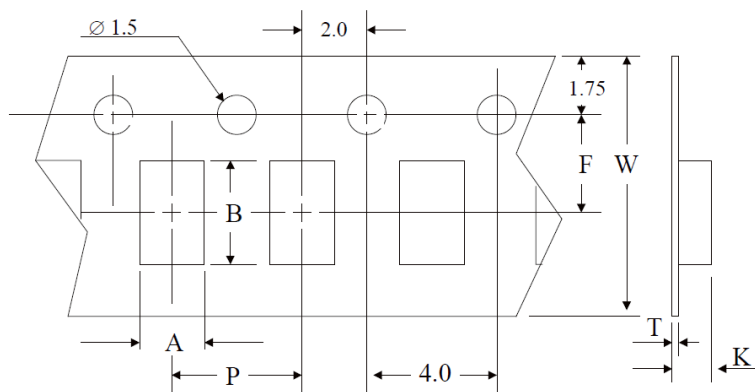

A	B	P	F	K	T	W
2.69	3.56	4.00	3.50	1.42	0.22	8.00

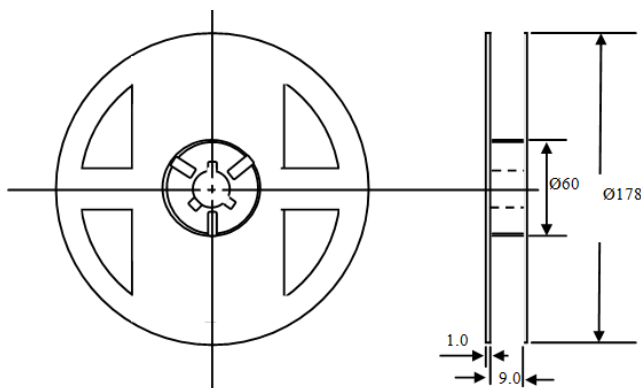

Dimension: mm

**ATTENTION:** Abracon Corporation's products are COTS – Commercial-Off-The-Shelf products; suitable for Commercial, Industrial and, where designated, Automotive Applications. Abracon's products are not specifically designed for Military, Aviation, Aerospace, Life-dependant Medical applications or any application requiring high reliability where component failure could result in loss of life and/or property. For applications requiring high reliability and/or presenting an extreme operating environment, written consent and authorization from Abracon Corporation is required. Please contact Abracon Corporation for more information.

ABRACON IS  
ISO 9001:2008  
CERTIFIED

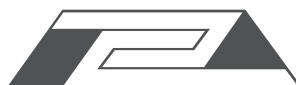

**ABRACON**  
CORPORATION

Visit [www.abracon.com](http://www.abracon.com) for Terms & Conditions of Sale  
30332 Esperanza, Rancho Santa Margarita, California 92688  
tel 949-546-8000 fax 949-546-8001 [www.abracon.com](http://www.abracon.com)

Revised: 12.08.11

# Mouser Electronics

Authorized Distributor

Click to View Pricing, Inventory, Delivery & Lifecycle Information:

## ABRACON:

[AISC-1210HS-100K-T2](#) [AISC-1210HS-120K-T2](#) [AISC-1210HS-150K-T2](#) [AISC-1210HS-180K-T2](#) [AISC-1210HS-220K-T2](#) [AISC-1210HS-270K-T2](#) [AISC-1210HS-2R2K-T2](#) [AISC-1210HS-2R7K-T2](#) [AISC-1210HS-330K-T2](#) [AISC-1210HS-3R3K-T2](#) [AISC-1210HS-3R9K-T2](#) [AISC-1210HS-4R7K-T2](#) [AISC-1210HS-5R6K-T2](#) [AISC-1210HS-6R8K-T2](#) [AISC-1210HS-8R2K-T2](#)