



Is Now Part of



**ON Semiconductor®**

To learn more about ON Semiconductor, please visit our website at  
[www.onsemi.com](http://www.onsemi.com)

Please note: As part of the Fairchild Semiconductor integration, some of the Fairchild orderable part numbers will need to change in order to meet ON Semiconductor's system requirements. Since the ON Semiconductor product management systems do not have the ability to manage part nomenclature that utilizes an underscore (\_), the underscore (\_) in the Fairchild part numbers will be changed to a dash (-). This document may contain device numbers with an underscore (\_). Please check the ON Semiconductor website to verify the updated device numbers. The most current and up-to-date ordering information can be found at [www.onsemi.com](http://www.onsemi.com). Please email any questions regarding the system integration to [Fairchild\\_questions@onsemi.com](mailto:Fairchild_questions@onsemi.com).

ON Semiconductor and the ON Semiconductor logo are trademarks of Semiconductor Components Industries, LLC dba ON Semiconductor or its subsidiaries in the United States and/or other countries. ON Semiconductor owns the rights to a number of patents, trademarks, copyrights, trade secrets, and other intellectual property. A listing of ON Semiconductor's product/patent coverage may be accessed at [www.onsemi.com/site/pdf/Patent-Marking.pdf](http://www.onsemi.com/site/pdf/Patent-Marking.pdf). ON Semiconductor reserves the right to make changes without further notice to any products herein. ON Semiconductor makes no warranty, representation or guarantee regarding the suitability of its products for any particular purpose, nor does ON Semiconductor assume any liability arising out of the application or use of any product or circuit, and specifically disclaims any and all liability, including without limitation special, consequential or incidental damages. Buyer is responsible for its products and applications using ON Semiconductor products, including compliance with all laws, regulations and safety requirements or standards, regardless of any support or applications information provided by ON Semiconductor. "Typical" parameters which may be provided in ON Semiconductor data sheets and/or specifications can and do vary in different applications and actual performance may vary over time. All operating parameters, including "Typicals" must be validated for each customer application by customer's technical experts. ON Semiconductor does not convey any license under its patent rights nor the rights of others. ON Semiconductor products are not designed, intended, or authorized for use as a critical component in life support systems or any FDA Class 3 medical devices or medical devices with a same or similar classification in a foreign jurisdiction or any devices intended for implantation in the human body. Should Buyer purchase or use ON Semiconductor products for any such unintended or unauthorized application, Buyer shall indemnify and hold ON Semiconductor and its officers, employees, subsidiaries, affiliates, and distributors harmless against all claims, costs, damages, and expenses, and reasonable attorney fees arising out of, directly or indirectly, any claim of personal injury or death associated with such unintended or unauthorized use, even if such claim alleges that ON Semiconductor was negligent regarding the design or manufacture of the part. ON Semiconductor is an Equal Opportunity/Affirmative Action Employer. This literature is subject to all applicable copyright laws and is not for resale in any manner.



March 2015



# FNB40560 / FNB40560B2

## Motion SPM<sup>®</sup> 45 Series

### Features

- UL Certified No. E209204 (UL1557)
- 600 V - 5 A 3-Phase IGBT Inverter with Integral Gate Drivers and Protection
- Low Thermal Resistance Using Ceramic Substrate
- Low-Loss, Short-Circuit Rated IGBTs
- Built-In Bootstrap Diodes and Dedicated Vs Pins Simplify PCB Layout
- Built-In NTC Thermistor for Temperature Monitoring
- Separate Open-Emitter Pins from Low-Side IGBTs for Three-Phase Current Sensing
- Single-Grounded Power Supply
- Isolation Rating: 2000 V<sub>rms</sub> / min.

### Applications

- Motion Control - Home Appliance / Industrial Motor

### Related Resources

- [AN-9070 - Motion SPM<sup>®</sup> 45 Series Users Guide](#)
- [AN-9071 - Motion SPM<sup>®</sup> 45 Series Thermal Performance Information](#)
- [AN-9072 - Motion SPM<sup>®</sup> 45 Series Mounting Guidance](#)
- [RD-344 - Reference Design \(Three Shunt Solution\)](#)
- [RD-345 - Reference Design \(One Shunt Solution\)](#)

### General Description

FNB40560 / FNB40560B2 is a Motion SPM<sup>®</sup> 45 module providing a fully-featured, high-performance inverter output stage for AC Induction, BLDC, and PMSM motors. These modules integrate optimized gate drive of the built-in IGBTs to minimize EMI and losses, while also providing multiple on-module protection features including under-voltage lockouts, over-current shutdown, thermal monitoring, and fault reporting. The built-in, high-speed HVIC requires only a single supply voltage and translates the incoming logic-level gate inputs to the high-voltage, high-current drive signals required to properly drive the module's robust short-circuit-rated IGBTs. Separate negative IGBT terminals are available for each phase to support the widest variety of control algorithms.

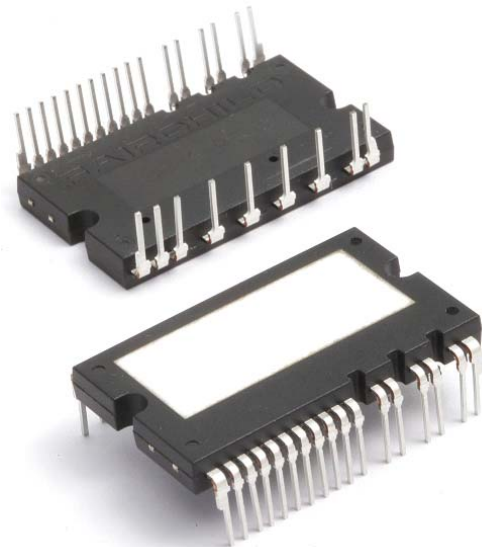

Figure 1. Package Overview

### Package Marking and Ordering Information

Device	Device Marking	Package	Packing Type	Quantity
FNB40560	FNB40560	SPMAA-A26	Rail	12
FNB40560B2	FNB40560B2	SPMAA-C26	Rail	12

### Integrated Power Functions

- 600 V - 5 A IGBT inverter for three-phase DC / AC power conversion (please refer to Figure 3)

### Integrated Drive, Protection, and System Control Functions

- For inverter high-side IGBTs: gate drive circuit, high-voltage isolated high-speed level shifting control circuit Under-Voltage Lock-Out (UVLO) protection
- For inverter low-side IGBTs: gate drive circuit, Short-Circuit Protection (SCP) control supply circuit Under-Voltage Lock-Out (UVLO) protection
- Fault signaling: corresponding to UVLO (low-side supply) and SC faults
- Input interface: active-HIGH interface, works with 3.3 / 5 V logic, Schmitt trigger input

### Pin Configuration



Figure 2. Top View

## Pin Descriptions

Pin Number	Pin Name	Pin Description
1	$V_{TH}$	Thermistor Bias Voltage
2	$R_{TH}$	Series Resistor for the Use of Thermistor (Temperature Detection)
3	P	Positive DC-Link Input
4	U	Output for U-Phase
5	V	Output for V-Phase
6	W	Output for W-Phase
7	$N_U$	Negative DC-Link Input for U-Phase
8	$N_V$	Negative DC-Link Input for V-Phase
9	$N_W$	Negative DC-Link Input for W-Phase
10	$C_{SC}$	Capacitor (Low-Pass Filter) for Short-circuit Current Detection Input
11	$V_{FO}$	Fault Output
12	$IN_{(WL)}$	Signal Input for Low-Side W-Phase
13	$IN_{(VL)}$	Signal Input for Low-Side V-Phase
14	$IN_{(UL)}$	Signal Input for Low-Side U-Phase
15	COM	Common Supply Ground
16	$V_{CC(L)}$	Low-Side Common Bias Voltage for IC and IGBTs Driving
17	$V_{CC(H)}$	High-Side Common Bias Voltage for IC and IGBTs Driving
18	$IN_{(WH)}$	Signal Input for High-Side W-Phase
19	$IN_{(VH)}$	Signal Input for High-Side V-Phase
20	$IN_{(UH)}$	Signal Input for High-Side U-Phase
21	$V_{S(W)}$	High-Side Bias Voltage Ground for W-Phase IGBT Driving
22	$V_{B(W)}$	High-Side Bias Voltage for W-Phase IGBT Driving
23	$V_{S(V)}$	High-Side Bias Voltage Ground for V-Phase IGBT Driving
24	$V_{B(V)}$	High-Side Bias Voltage for V-Phase IGBT Driving
25	$V_{S(U)}$	High-Side Bias Voltage Ground for U-Phase IGBT Driving
26	$V_{B(U)}$	High-Side Bias Voltage for U-Phase IGBT Driving

## Internal Equivalent Circuit and Input/Output Pins



**Figure 3. Internal Block Diagram**

**1st Notes:**

1. Inverter high-side is composed of three IGBTs, freewheeling diodes, and one control IC for each IGBT.
2. Inverter low-side is composed of three IGBTs, freewheeling diodes, and one control IC for each IGBT. It has gate drive and protection functions.
3. Inverter power side is composed of four inverter DC-link input terminals and three inverter output terminals.

## Absolute Maximum Ratings ( $T_J = 25^\circ\text{C}$ , unless otherwise specified.)

### Inverter Part

Symbol	Parameter	Conditions	Rating	Unit
$V_{PN}$	Supply Voltage	Applied between P - $N_U$ , $N_V$ , $N_W$	450	V
$V_{PN(\text{Surge})}$	Supply Voltage (Surge)	Applied between P - $N_U$ , $N_V$ , $N_W$	500	V
$V_{CES}$	Collector - Emitter Voltage		600	V
$I_{O,25}$	Output Phase Current	$T_C = 25^\circ\text{C}$ , $T_J < 150^\circ\text{C}$ (2nd Note 1)	5	A
$I_{O,100}$	Output Phase Current	$T_C = 100^\circ\text{C}$ , $T_J < 150^\circ\text{C}$ (2nd Note 1)	2.5	A
$I_{pk}$	Output Peak Phase Current	$T_C = 25^\circ\text{C}$ , $T_J < 150^\circ\text{C}$ , Under 1 ms Pulse Width	7.5	A
$P_C$	Collector Dissipation	$T_C = 25^\circ\text{C}$ per Chip	29	W
$T_J$	Operating Junction Temperature	(2nd Note 2)	-40 ~ 150	$^\circ\text{C}$

#### 2nd Notes:

- Sinusoidal PWM at  $V_{PN} = 300\text{ V}$ ,  $V_{CC} = V_{BS} = 15\text{ V}$ ,  $T_J < 150^\circ\text{C}$ ,  $F_{SW} = 20\text{ kHz}$ ,  $MI = 0.9$ ,  $PF = 0.8$
- The maximum junction temperature rating of the power chips integrated within the Motion SPM® 45 product is  $150^\circ\text{C}$ .

### Control Part

Symbol	Parameter	Conditions	Rating	Unit
$V_{CC}$	Control Supply Voltage	Applied between $V_{CC(H)}$ , $V_{CC(L)}$ - COM	20	V
$V_{BS}$	High - Side Control Bias Voltage	Applied between $V_{B(U)} - V_{S(U)}$ , $V_{B(V)} - V_{S(V)}$ , $V_{B(W)} - V_{S(W)}$	20	V
$V_{IN}$	Input Signal Voltage	Applied between $IN_{(UH)}$ , $IN_{(VH)}$ , $IN_{(WH)}$ , $IN_{(UL)}$ , $IN_{(VL)}$ , $IN_{(WL)}$ - COM	-0.3 ~ $V_{CC} + 0.3$	V
$V_{FO}$	Fault Output Supply Voltage	Applied between $V_{FO}$ - COM	-0.3 ~ $V_{CC} + 0.3$	V
$I_{FO}$	Fault Output Current	Sink Current at $V_{FO}$ pin	1	mA
$V_{SC}$	Current-Sensing Input Voltage	Applied between $C_{SC}$ - COM	-0.3 ~ $V_{CC} + 0.3$	V

### Bootstrap Diode Part

Symbol	Parameter	Conditions	Rating	Unit
$V_{RRM}$	Maximum Repetitive Reverse Voltage		600	V
$I_F$	Forward Current	$T_C = 25^\circ\text{C}$ , $T_J < 150^\circ\text{C}$	0.50	A
$I_{FP}$	Forward Current (Peak)	$T_C = 25^\circ\text{C}$ , $T_J < 150^\circ\text{C}$ , Under 1 ms Pulse Width	1.50	A
$T_J$	Operating Junction Temperature		-40 ~ 150	$^\circ\text{C}$

### Total System

Symbol	Parameter	Conditions	Rating	Unit
$V_{PN(\text{PROT})}$	Self-Protection Supply Voltage Limit (Short-Circuit Protection Capability)	$V_{CC} = V_{BS} = 13.5 \sim 16.5\text{ V}$ $T_J = 150^\circ\text{C}$ , Non-Repetitive, $< 2\ \mu\text{s}$	400	V
$T_{STG}$	Storage Temperature		-40 ~ 125	$^\circ\text{C}$
$V_{ISO}$	Isolation Voltage	60 Hz, Sinusoidal, AC 1 Minute, Connect Pins to Heat Sink Plate	2000	$V_{rms}$

### Thermal Resistance

Symbol	Parameter	Conditions	Min.	Typ.	Max.	Unit
$R_{th(j-c)Q}$	Junction to Case Thermal Resistance	Inverter IGBT Part (per 1 / 6 module)	-	-	4.2	$^\circ\text{C} / \text{W}$
$R_{th(j-c)F}$		Inverter FWDi Part (per 1 / 6 module)	-	-	5.9	$^\circ\text{C} / \text{W}$

#### 2nd Notes:

- For the measurement point of case temperature ( $T_C$ ), please refer to Figure 2.

### Electrical Characteristics ( $T_J = 25^\circ\text{C}$ , unless otherwise specified.)

#### Inverter Part

Symbol	Parameter	Conditions	Min.	Typ.	Max.	Unit	
$V_{CE(SAT)}$	Collector - Emitter Saturation Voltage	$V_{CC} = V_{BS} = 15\text{ V}$ $V_{IN} = 5\text{ V}$ $I_C = 2.5\text{ A}, T_J = 25^\circ\text{C}$	-	1.4	1.9	V	
$V_F$	FWDI Forward Voltage	$V_{IN} = 0\text{ V}$ $I_F = 2.5\text{ A}, T_J = 25^\circ\text{C}$	-	1.4	1.9	V	
HS	Switching Times	$V_{PN} = 300\text{ V}, V_{CC} = V_{BS} = 15\text{ V}, I_C = 2.5\text{ A}$ $T_J = 25^\circ\text{C}$ $V_{IN} = 0\text{ V} \leftrightarrow 5\text{ V}$ , Inductive Load (2nd Note 4)	$t_{ON}$	0.35	0.65	1.15	$\mu\text{s}$
			$t_{C(ON)}$	-	0.10	0.35	$\mu\text{s}$
			$t_{OFF}$	-	0.70	1.20	$\mu\text{s}$
			$t_{C(OFF)}$	-	0.20	0.45	$\mu\text{s}$
			$t_{rr}$	-	0.15	-	$\mu\text{s}$
LS	Switching Times	$V_{PN} = 300\text{ V}, V_{CC} = V_{BS} = 15\text{ V}, I_C = 2.5\text{ A}$ $T_J = 25^\circ\text{C}$ $V_{IN} = 0\text{ V} \leftrightarrow 5\text{ V}$ , Inductive Load (2nd Note 4)	$t_{ON}$	0.35	0.65	1.15	$\mu\text{s}$
			$t_{C(ON)}$	-	0.10	0.35	$\mu\text{s}$
			$t_{OFF}$	-	0.70	1.20	$\mu\text{s}$
			$t_{C(OFF)}$	-	0.20	0.45	$\mu\text{s}$
			$t_{rr}$	-	0.15	-	$\mu\text{s}$
$I_{CES}$	Collector - Emitter Leakage Current	$V_{CE} = V_{CES}$	-	-	1	mA	

**2nd Notes:**

4.  $t_{ON}$  and  $t_{OFF}$  include the propagation delay of the internal drive IC.  $t_{C(ON)}$  and  $t_{C(OFF)}$  are the switching time of IGBT itself under the given gate driving condition internally. For the detailed information, please see Figure 4.

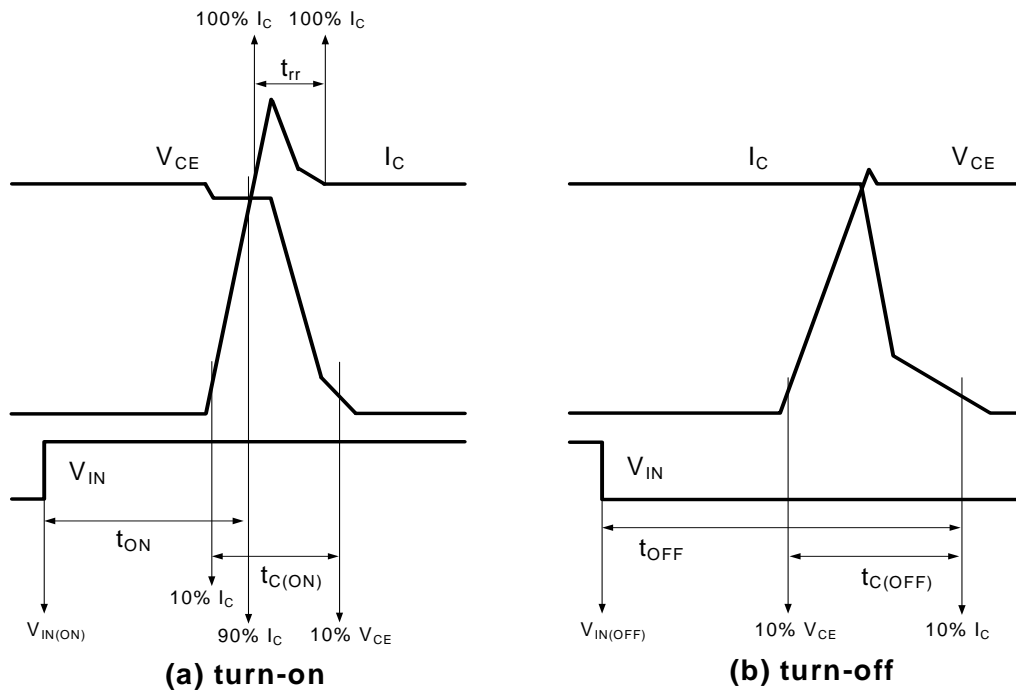

**Figure 4. Switching Time Definition**

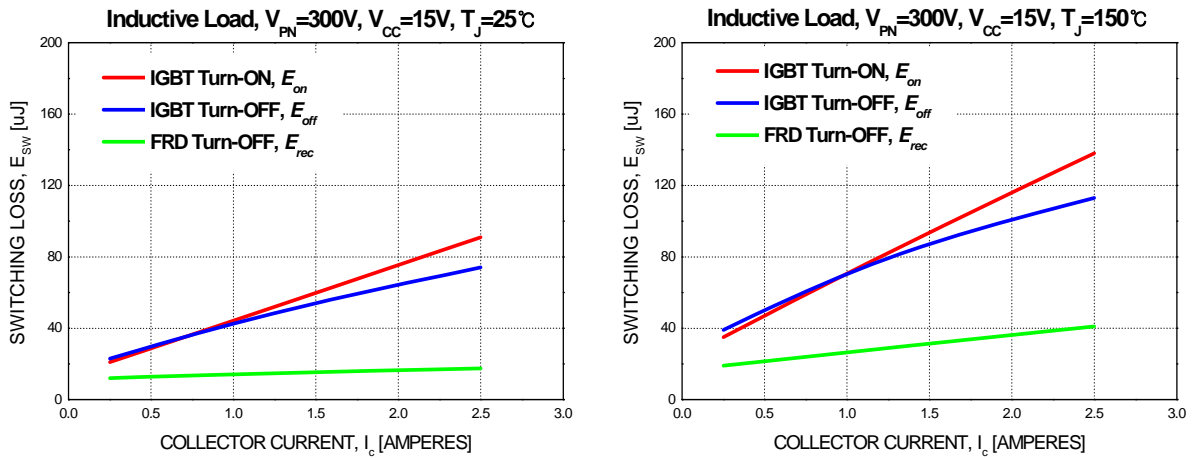

**Figure 5. Switching Loss Characteristics (Typical)**

**Control Part**

Symbol	Parameter	Conditions	Min.	Typ.	Max.	Unit	
I <sub>QCCH</sub>	Quiescent V <sub>CC</sub> Supply Current	V <sub>CC(H)</sub> = 15 V, I <sub>N(UH, VH, WH)</sub> = 0 V	V <sub>CC(H)</sub> - COM	-	-	0.10	mA
I <sub>QCCL</sub>		V <sub>CC(L)</sub> = 15 V, I <sub>N(UL, VL, WL)</sub> = 0 V	V <sub>CC(L)</sub> - COM	-	-	2.65	mA
I <sub>PCCH</sub>	Operating V <sub>CC</sub> Supply Current	V <sub>CC(L)</sub> = 15 V, f <sub>PWM</sub> = 20 kHz, duty = 50%, Applied to One PWM Signal Input for High-Side	V <sub>CC(H)</sub> - COM	-	-	0.15	mA
I <sub>PCCL</sub>		V <sub>CC(L)</sub> = 15 V, f <sub>PWM</sub> = 20 kHz, duty = 50%, Applied to One PWM Signal Input for Low-Side	V <sub>CC(L)</sub> - COM	-	-	3.65	mA
I <sub>QBS</sub>	Quiescent V <sub>BS</sub> Supply Current	V <sub>BS</sub> = 15 V, I <sub>N(UH, VH, WH)</sub> = 0 V	V <sub>B(U)</sub> - V <sub>S(U)</sub> , V <sub>B(V)</sub> - V <sub>S(V)</sub> , V <sub>B(W)</sub> - V <sub>S(W)</sub>	-	-	0.30	mA
I <sub>PBS</sub>	Operating V <sub>BS</sub> Supply Current	V <sub>CC</sub> = V <sub>BS</sub> = 15 V, f <sub>PWM</sub> = 20 kHz, Duty = 50%, Applied to One PWM Signal Input for High-Side	V <sub>B(U)</sub> - V <sub>S(U)</sub> , V <sub>B(V)</sub> - V <sub>S(V)</sub> , V <sub>B(W)</sub> - V <sub>S(W)</sub>	-	-	2.00	mA
V <sub>FOH</sub>	Fault Output Voltage	V <sub>SC</sub> = 0 V, V <sub>FO</sub> Circuit: 10 kΩ to 5 V Pull-up		4.5	-	-	V
V <sub>FOL</sub>		V <sub>SC</sub> = 1 V, V <sub>FO</sub> Circuit: 10 kΩ to 5 V Pull-up		-	-	0.5	V
V <sub>SC(ref)</sub>	Short-Circuit Current Trip Level	V <sub>CC</sub> = 15 V (2nd Note 5)		0.45	0.50	0.55	V
UV <sub>CCD</sub>	Supply Circuit Under-Voltage Protection	Detection level		10.5	-	13.0	V
UV <sub>CCR</sub>		Reset level		11.0	-	13.5	V
UV <sub>BSD</sub>		Detection level		10.0	-	12.5	V
UV <sub>BSR</sub>		Reset level		10.5	-	13.0	V
t <sub>FOD</sub>	Fault-Out Pulse Width			30	-	-	μs
V <sub>IN(ON)</sub>	ON Threshold Voltage	Applied between I <sub>N(UH)</sub> , I <sub>N(VH)</sub> , I <sub>N(WH)</sub> , I <sub>N(UL)</sub> , I <sub>N(VL)</sub> , I <sub>N(WL)</sub> - COM		-	-	2.6	V
V <sub>IN(OFF)</sub>	OFF Threshold Voltage			0.8	-	-	V
R <sub>TH</sub>	Resistance of Thermister	@ T <sub>TH</sub> = 25°C, (2nd Note 6)		-	47	-	kΩ
		@ T <sub>TH</sub> = 100°C		-	2.9	-	kΩ

**2nd Notes:**

- Short-circuit protection is functioning only at the low-sides.
- T<sub>TH</sub> is the temperature of thermister itself. To know case temperature (T<sub>C</sub>), please make the experiment considering your application.





Figure. 6. R-T Curve of The Built-In Thermistor

**Bootstrap Diode Part**

Symbol	Parameter	Conditions	Min.	Typ.	Max.	Unit
$V_F$	Forward Voltage	$I_F = 0.1 \text{ A}, T_C = 25^\circ\text{C}$	-	2.5	-	V
$t_{rr}$	Reverse-Recovery Time	$I_F = 0.1 \text{ A}, T_C = 25^\circ\text{C}$	-	80	-	ns

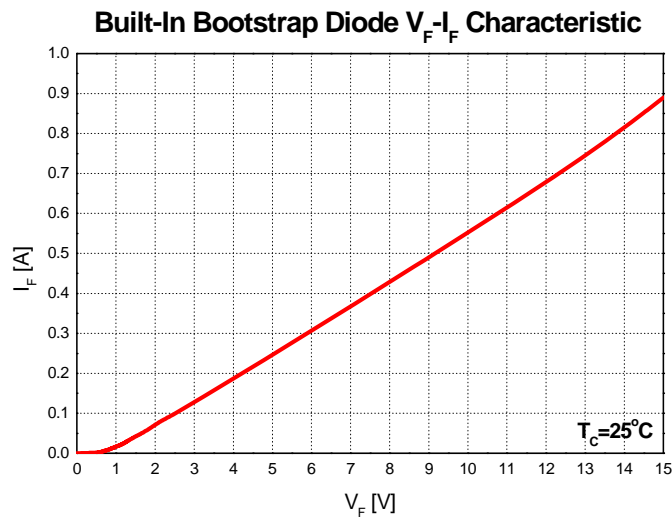

Figure 7. Built-In Bootstrap Diode Characteristic

**2nd Notes:**

7. Built-in bootstrap diode includes around 15  $\Omega$  resistance characteristic.

### Recommended Operating Conditions

Symbol	Parameter	Conditions	Min.	Typ.	Max.	Unit
$V_{PN}$	Supply Voltage	Applied between P - $N_U, N_V, N_W$	-	300	400	V
$V_{CC}$	Control Supply Voltage	Applied between $V_{CC(H)}, V_{CC(L)}$ - COM	13.5	15	16.5	V
$V_{BS}$	High-Side Bias Voltage	Applied between $V_{B(U)} - V_{S(U)}, V_{B(V)} - V_{S(V)}, V_{B(W)} - V_{S(W)}$	13.0	15	18.5	V
$dV_{CC}/dt, dV_{BS}/dt$	Control Supply Variation		- 1	-	1	V / $\mu$ s
$t_{dead}$	Blanking Time for Preventing Arm-Short	For each input signal	1.5	-	-	$\mu$ s
$f_{PWM}$	PWM Input Signal	$- 40^\circ\text{C} < T_J < 150^\circ\text{C}$	-	-	20	kHz
$V_{SEN}$	Voltage for Current Sensing	Applied between $N_U, N_V, N_W$ - COM (Including Surge-Voltage)	- 4		4	V
$P_{WIN(ON)}$	Minimum Input Pulse Width	(2nd Note 8)	0.5	-	-	$\mu$ s
$P_{WIN(OFF)}$			0.5	-	-	

**2nd Notes:**

8. This product might not make response if input pulse width is less than the recommended value.

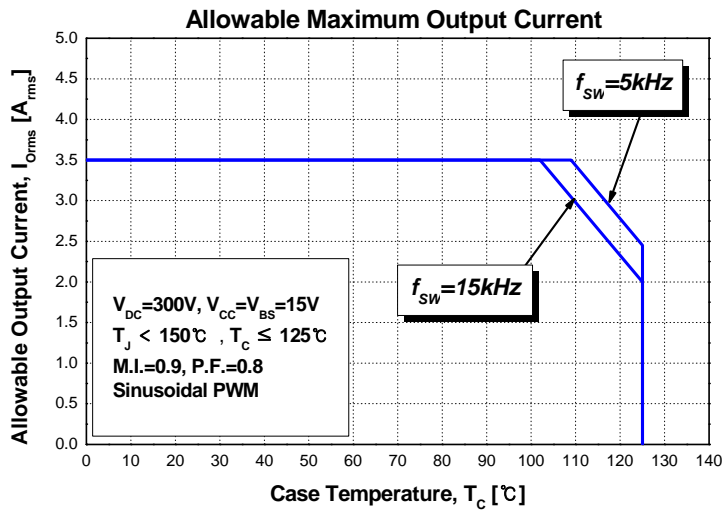

**Figure 8. Allowable Maximum Output Current**

**2nd Notes:**

9. This allowable output current value is the reference data for the safe operation of this product. This may be different from the actual application and operating condition.

## Mechanical Characteristics and Ratings

Parameter	Conditions	Min.	Typ.	Max.	Unit	
Device Flatness	See Figure 9	0	-	+ 120	μm	
Mounting Torque	Mounting Screw: M3	Recommended 0.7 N • m	0.6	0.7	0.8	N • m
	See Figure 10	Recommended 7.1 kg • cm	6.2	7.1	8.1	kg • cm
Weight		-	11	-	g	



Figure 9. Flatness Measurement Position

**Pre - Screwing : 1→2**

**Final Screwing : 2→1**

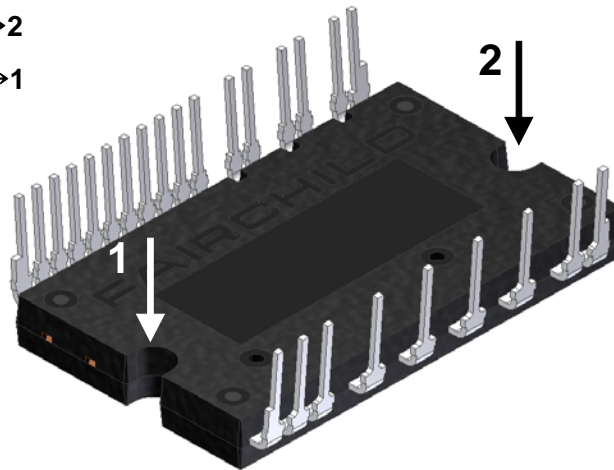
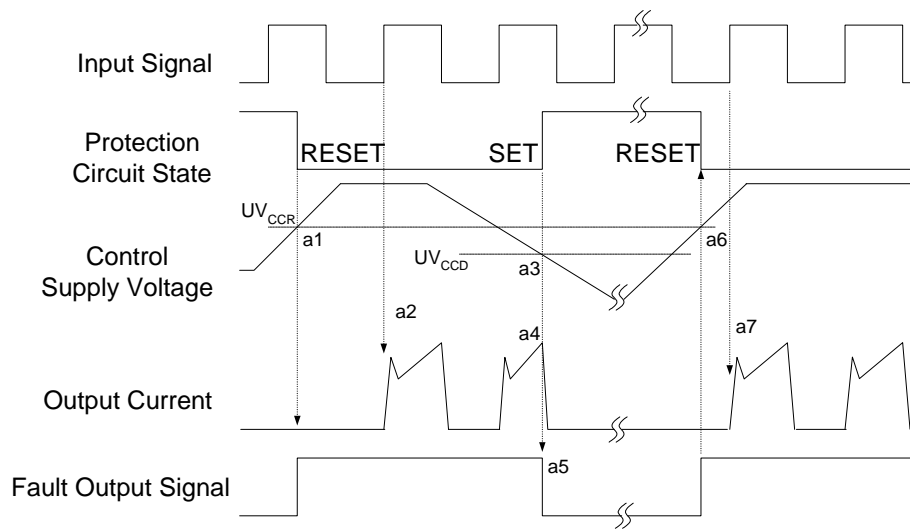

Figure 10. Mounting Screws Torque Order

**2nd Notes:**

- 10. Do not make over torque when mounting screws. Much mounting torque may cause ceramic cracks, as well as bolts and Al heat-sink destruction.
- 11. Avoid one side tightening stress. Figure 10 shows the recommended torque order for mounting screws. Uneven mounting can cause the ceramic substrate of the SPM® 45 package to be damaged. The pre-screwing torque is set to 20 ~ 30% of maximum torque rating.

### Time Charts of Protective Function



- a1 : Control supply voltage rises: after the voltage rises  $UV_{CCR}$ , the circuits start to operate when next input is applied.
- a2 : Normal operation: IGBT ON and carrying current.
- a3 : Under-voltage detection ( $UV_{CCD}$ ).
- a4 : IGBT OFF in spite of control input condition.
- a5 : Fault output operation starts.
- a6 : Under-voltage reset ( $UV_{CCR}$ ).
- a7 : Normal operation: IGBT ON and carrying current.

**Figure 11. Under-Voltage Protection (Low-Side)**

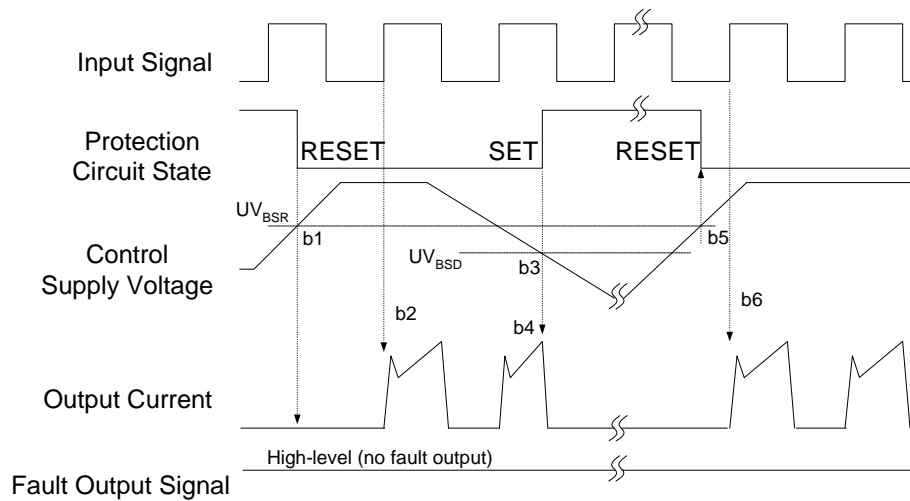

- b1 : Control supply voltage rises: after the voltage reaches  $UV_{BSR}$ , the circuits start to operate when next input is applied.
- b2 : Normal operation: IGBT ON and carrying current.
- b3 : Under-voltage detection ( $UV_{BSD}$ ).
- b4 : IGBT OFF in spite of control input condition, but there is no fault output signal.
- b5 : Under-voltage reset ( $UV_{BSR}$ ).
- b6 : Normal operation: IGBT ON and carrying current.

**Figure 12. Under-Voltage Protection (High-Side)**



(with the external shunt resistance and CR connection)

- c1 : Normal operation: IGBT ON and carrying current.
- c2 : Short-circuit current detection (SC trigger).
- c3 : Hard IGBT gate interrupt.
- c4 : IGBT turns OFF.
- c5 : Input "LOW": IGBT OFF state.
- c6 : Input "HIGH": IGBT ON state, but during the active period of fault output, the IGBT doesn't turn ON.
- c7 : IGBT OFF state.

**Figure 13. Short-Circuit Protection (Low-Side Operation Only)**

### Input/Output Interface Circuit



**Figure 14. Recommended MCU I/O Interface Circuit**

**2nd Notes:**

12. RC coupling at each input (parts shown dotted) might change depending on the PWM control scheme in the application and the wiring impedance of the application's printed circuit board. The input signal section of the Motion SPM® 45 product integrates a 5 kΩ (typ.) pull-down resistor. Therefore, when using an external filtering resistor, pay attention to the signal voltage drop at input terminal.

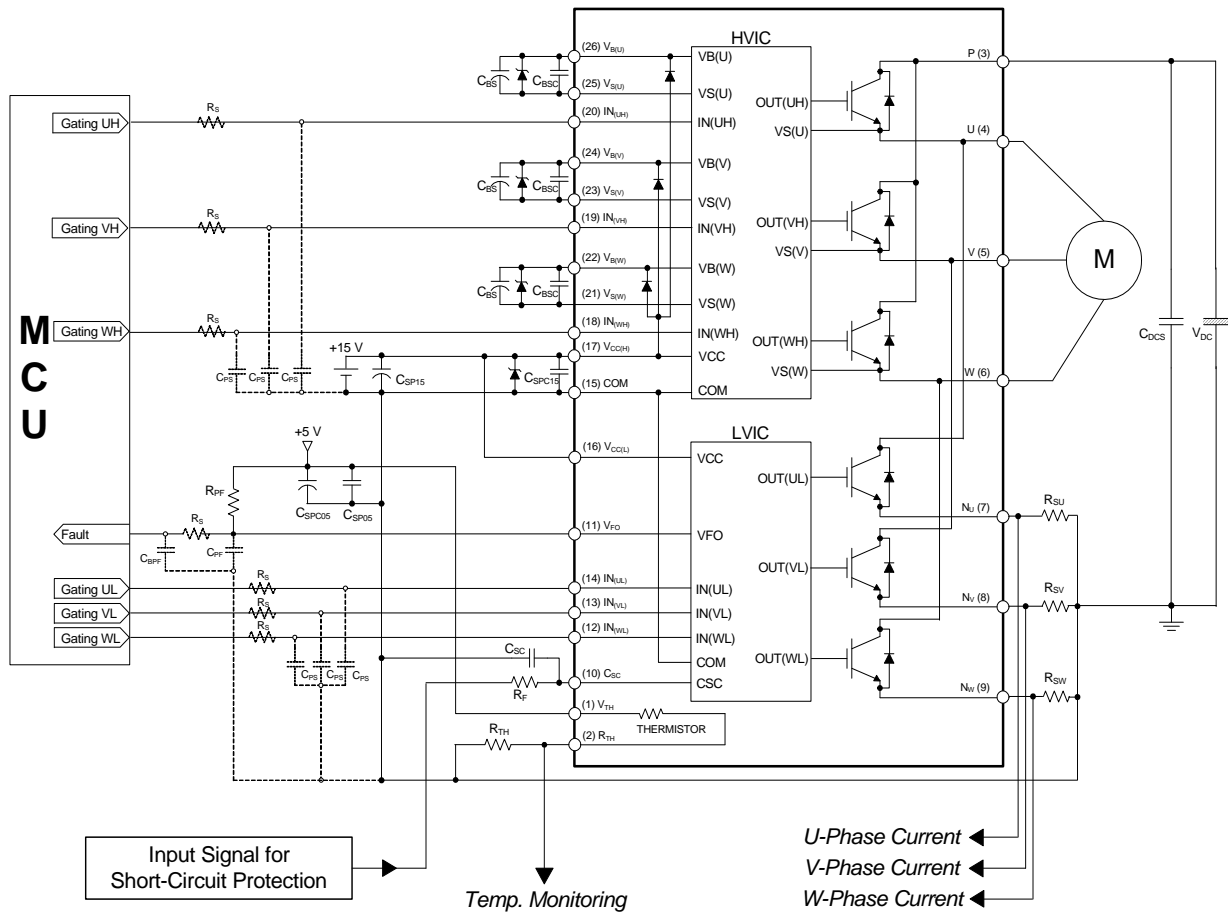
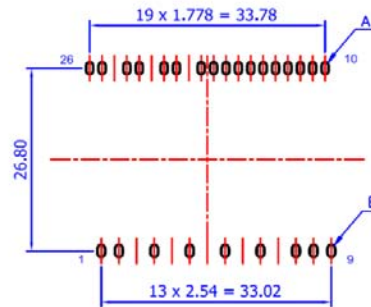
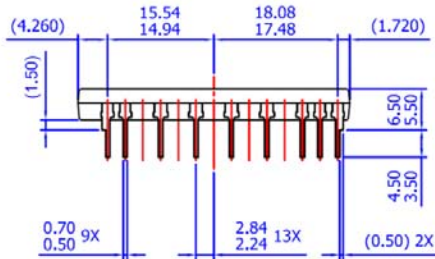
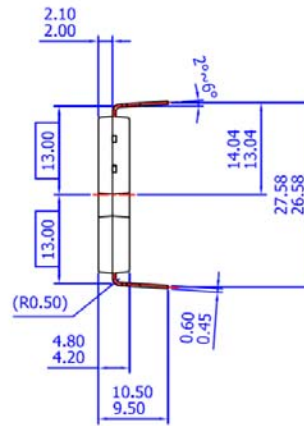
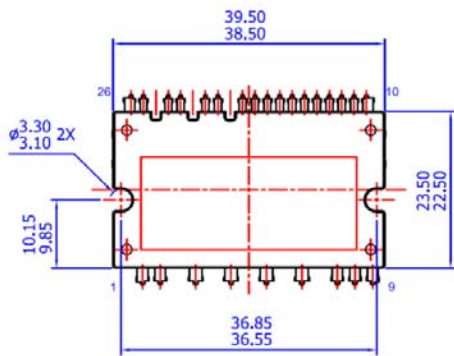
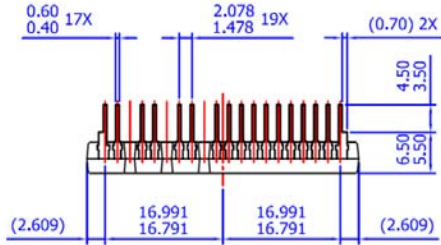

**Figure 15. Typical Application Circuit**

**3rd Notes:**

- 1) To avoid malfunction, the wiring of each input should be as short as possible (less than 2 - 3 cm).
- 2) By virtue of integrating an application-specific type of HVIC inside the Motion SPM® 45 product, direct coupling to MCU terminals without any optocoupler or transformer isolation is possible.
- 3) V<sub>FO</sub> output is open-drain type. This signal line should be pulled up to the positive side of the MCU or control power supply with a resistor that makes I<sub>FO</sub> up to 1 mA (please refer to Figure 14).
- 4) C<sub>SP15</sub> of around seven times larger than bootstrap capacitor C<sub>BS</sub> is recommended.
- 5) Input signal is active-HIGH type. There is a 5 kΩ resistor inside the IC to pull down each input signal line to GND. RC coupling circuits is recommended for the prevention of input signal oscillation. R<sub>SPS</sub> time constant should be selected in the range 50 ~ 150 ns (recommended R<sub>S</sub> = 100 Ω, C<sub>PS</sub> = 1 nF).
- 6) To prevent errors of the protection function, the wiring around R<sub>F</sub> and C<sub>SC</sub> should be as short as possible.
- 7) In the short-circuit protection circuit, please select the R<sub>F</sub>C<sub>SC</sub> time constant in the range 1.5 ~ 2 μs.
- 8) The connection between control GND line and power GND line which includes the N<sub>U</sub>, N<sub>V</sub>, N<sub>W</sub> must be connected to only one point. Please do not connect the control GND to the power GND by the broad pattern. Also, the wiring distance between control GND and power GND should be as short as possible.
- 9) Each capacitor should be mounted as close to the pins of the Motion SPM 45 product as possible.
- 10) To prevent surge destruction, the wiring between the smoothing capacitor and the P & GND pins should be as short as possible. The use of a high-frequency non-inductive capacitor of around 0.1 ~ 0.22 μF between the P and GND pins is recommended.
- 11) Relays are used in almost every systems of electrical equipment in home appliances. In these cases, there should be sufficient distance between the MCU and the relays.
- 12) The zener diode or transient voltage suppressor should be adopted for the protection of ICs from the surge destruction between each pair of control supply terminals (recommended zener diode is 22 V / 1 W, which has the lower zener impedance characteristic than about 15 Ω).
- 13) Please choose the electrolytic capacitor with good temperature characteristic in C<sub>BS</sub>. Also, choose 0.1 ~ 0.2 μF R-category ceramic capacitors with good temperature and frequency characteristics in C<sub>BSC</sub>.
- 14) For the detailed information, please refer to the AN-9070, AN-9071, AN-9072, RD-344, and RD-345.

### Detailed Package Outline Drawings (FNB40560)



LAND PATTERN RECOMMENDATIONS

- NOTES: UNLESS OTHERWISE SPECIFIED  
 A) THIS PACKAGE DOES NOT COMPLY TO ANY CURRENT PACKAGING STANDARD  
 B) ALL DIMENSIONS ARE IN MILLIMETERS  
 C) DIMENSIONS ARE EXCLUSIVE OF BURRS, MOLD FLASH, AND TIE BAR EXTRUSIONS  
 D) ( ) IS REFERENCE  
 E) [ ] IS ASS'Y QUALITY  
 F) DRAWING FILENAME: MOD26AAREV2.0

Package drawings are provided as a service to customers considering Fairchild components. Drawings may change in any manner without notice. Please note the revision and/or data on the drawing and contact a Fairchild Semiconductor representative to verify or obtain the most recent revision. Package specifications do not expand the terms of Fairchild's worldwide terms and conditions, specifically the the warranty therein, which covers Fairchild products.

Always visit Fairchild Semiconductor's online packaging area for the most recent package drawings:

<http://www.fairchildsemi.com/dwg/MO/MOD26AA.pdf>

### Detailed Package Outline Drawings (FNB40560B2, Long Terminal Type)

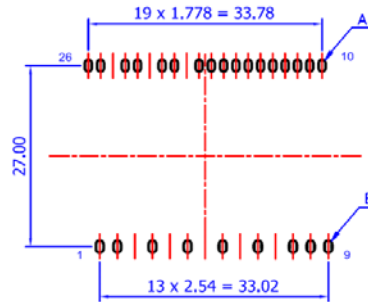
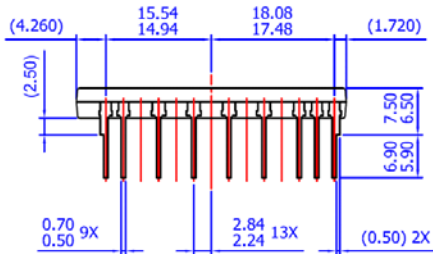
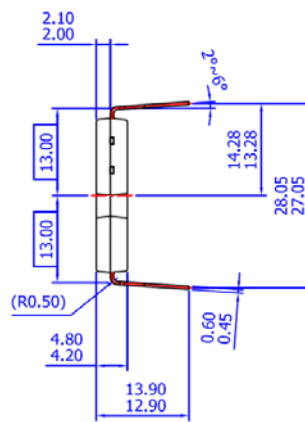
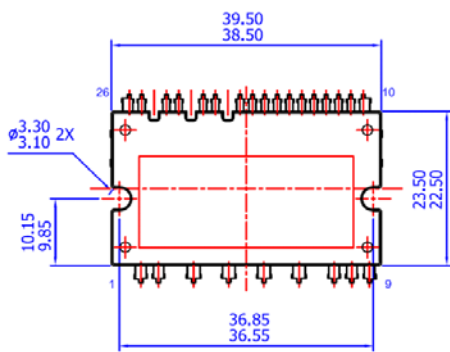
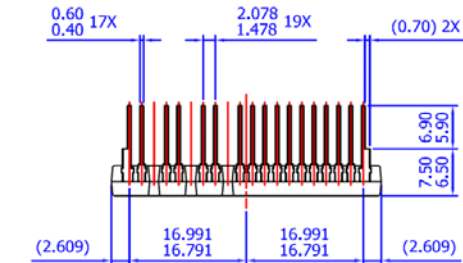

- NOTES: UNLESS OTHERWISE SPECIFIED
- A) THIS PACKAGE DOES NOT COMPLY TO ANY CURRENT PACKAGING STANDARD
  - B) ALL DIMENSIONS ARE IN MILLIMETERS
  - C) DIMENSIONS ARE EXCLUSIVE OF BURRS, MOLD FLASH, AND TIE BAR EXTRUSIONS
  - D) ( ) IS REFERENCE
  - E) [ ] IS ASS'Y QUALITY
  - F) DRAWING FILENAME: MOD26ACREV2.0

#### LAND PATTERN RECOMMENDATIONS

Package drawings are provided as a service to customers considering Fairchild components. Drawings may change in any manner without notice. Please note the revision and/or data on the drawing and contact a Fairchild Semiconductor representative to verify or obtain the most recent revision. Package specifications do not expand the terms of Fairchild's worldwide therm and conditions, specifically the the warranty therein, which covers Fairchild products.

Always visit Fairchild Semiconductor's online packaging area for the most recent package drawings:





<http://www.fairchildsemi.com/dwg/MO/MOD26AC.pdf>





**TRADEMARKS**

The following includes registered and unregistered trademarks and service marks, owned by Fairchild Semiconductor and/or its global subsidiaries, and is not intended to be an exhaustive list of all such trademarks.

- |   |  |   |   |
|---|--|---|---|
| AccuPower™  | F-PFS™   | OPTOPLANAR®   |  |
| AltitudeEngine™   | FRFET®   |  | TinyBoost®  |
| Awinda®   | Global Power Resource™                         | Power Supply WebDesigner™   | TinyBuck®   |
| AX-CAP®*  | GreenBridge™                                   | PowerTrench®  | TinyCalc™   |
| BitSiC™   | Green FPS™                                     | PowerXS™  | TinyLogic®  |
| Build it Now™   | Green FPS™ e-Series™                           | Programmable Active Droop™  | TINYOPTO™   |
| CorePLUS™   | Gmax™  | QFET®   | TinyPower™  |
| CorePOWER™  | GTO™   | QS™   | TinyPWM™  |
| CROSSVOL™   | IntelliMAX™                                    | Quiet Series™   | TinyWire™   |
| CTL™  | ISOPLANAR™                                     | RapidConfigure™   | TranSiC™  |
| Current Transfer Logic™   | Making Small Speakers Sound Louder and Better™ |  | TriFault Detect™  |
| DEUXPEED®   | MegaBuck™                                      | Saving our world, 1mW/W/kW at a time™   | TRUECURRENT®*   |
| Dual Cool™  | MICROCOUPLER™                                  | SignalWise™   | µSerDes™  |
| EcoSPARK®   | MicroFET™                                      | SmartMax™   |  |
| EfficientMax™   | MicroPak™                                      | SMART START™  | UHC™  |
| ESBC™   | MicroPak2™                                     | Solutions for Your Success™   | Ultra FRFET™  |
|  | MillerDrive™                                   | SPM®  | UniFET™   |
| Fairchild®  | MotionMax™                                     | STEALTH™  | VCX™  |
| Fairchild Semiconductor®  | MotionGrid®                                    | SuperFET®   | VisualMax™  |
| FACT Quiet Series™  | MTI®   | SuperSOT™-3   | VoltagePlus™  |
| FACT®   | MTX®   | SuperSOT™-6   | XS™   |
| FastvCore™  | MVN®   | SuperSOT™-8   | Xsens™  |
| FETBench™   | mWSaver®                                       | SupreMOS®   | 仙童®   |
| FPS™  | OptoHi™  | SyncFET™  |   |
|   | OPTOLOGIC®                                     | Sync-Lock™  |   |

\* Trademarks of System General Corporation, used under license by Fairchild Semiconductor.

**DISCLAIMER**

FAIRCHILD SEMICONDUCTOR RESERVES THE RIGHT TO MAKE CHANGES WITHOUT FURTHER NOTICE TO ANY PRODUCTS HEREIN TO IMPROVE RELIABILITY, FUNCTION, OR DESIGN. TO OBTAIN THE LATEST, MOST UP-TO-DATE DATASHEET AND PRODUCT INFORMATION, VISIT OUR WEBSITE AT [HTTP://WWW.FAIRCHILDSEMI.COM](http://www.fairchildsemi.com). FAIRCHILD DOES NOT ASSUME ANY LIABILITY ARISING OUT OF THE APPLICATION OR USE OF ANY PRODUCT OR CIRCUIT DESCRIBED HEREIN; NEITHER DOES IT CONVEY ANY LICENSE UNDER ITS PATENT RIGHTS, NOR THE RIGHTS OF OTHERS. THESE SPECIFICATIONS DO NOT EXPAND THE TERMS OF FAIRCHILD'S WORLDWIDE TERMS AND CONDITIONS, SPECIFICALLY THE WARRANTY THEREIN, WHICH COVERS THESE PRODUCTS.

**AUTHORIZED USE**

Unless otherwise specified in this data sheet, this product is a standard commercial product and is not intended for use in applications that require extraordinary levels of quality and reliability. This product may not be used in the following applications, unless specifically approved in writing by a Fairchild officer: (1) automotive or other transportation, (2) military/aerospace, (3) any safety critical application – including life critical medical equipment – where the failure of the Fairchild product reasonably would be expected to result in personal injury, death or property damage. Customer's use of this product is subject to agreement of this Authorized Use policy. In the event of an unauthorized use of Fairchild's product, Fairchild accepts no liability in the event of product failure. In other respects, this product shall be subject to Fairchild's Worldwide Terms and Conditions of Sale, unless a separate agreement has been signed by both Parties.

**ANTI-COUNTERFEITING POLICY**

Fairchild Semiconductor Corporation's Anti-Counterfeiting Policy. Fairchild's Anti-Counterfeiting Policy is also stated on our external website, [www.fairchildsemi.com](http://www.fairchildsemi.com), under Terms of Use

Counterfeiting of semiconductor parts is a growing problem in the industry. All manufacturers of semiconductor products are experiencing counterfeiting of their parts. Customers who inadvertently purchase counterfeit parts experience many problems such as loss of brand reputation, substandard performance, failed applications, and increased cost of production and manufacturing delays. Fairchild is taking strong measures to protect ourselves and our customers from the proliferation of counterfeit parts. Fairchild strongly encourages customers to purchase Fairchild parts either directly from Fairchild or from Authorized Fairchild Distributors who are listed by country on our web page cited above. Products customers buy either from Fairchild directly or from Authorized Fairchild Distributors are genuine parts, have full traceability, meet Fairchild's quality standards for handling and storage and provide access to Fairchild's full range of up-to-date technical and product information. Fairchild and our Authorized Distributors will stand behind all warranties and will appropriately address any warranty issues that may arise. Fairchild will not provide any warranty coverage or other assistance for parts bought from Unauthorized Sources. Fairchild is committed to combat this global problem and encourage our customers to do their part in stopping this practice by buying direct or from authorized distributors.

**PRODUCT STATUS DEFINITIONS**

**Definition of Terms**

Datasheet Identification	Product Status	Definition
Advance Information	Formative / In Design	Datasheet contains the design specifications for product development. Specifications may change in any manner without notice.
Preliminary	First Production	Datasheet contains preliminary data; supplementary data will be published at a later date. Fairchild Semiconductor reserves the right to make changes at any time without notice to improve design.
No Identification Needed	Full Production	Datasheet contains final specifications. Fairchild Semiconductor reserves the right to make changes at any time without notice to improve the design.
Obsolete	Not In Production	Datasheet contains specifications on a product that is discontinued by Fairchild Semiconductor. The datasheet is for reference information only.

Rev. I77

ON Semiconductor and  are trademarks of Semiconductor Components Industries, LLC dba ON Semiconductor or its subsidiaries in the United States and/or other countries. ON Semiconductor owns the rights to a number of patents, trademarks, copyrights, trade secrets, and other intellectual property. A listing of ON Semiconductor's product/patent coverage may be accessed at [www.onsemi.com/site/pdf/Patent-Marking.pdf](http://www.onsemi.com/site/pdf/Patent-Marking.pdf). ON Semiconductor reserves the right to make changes without further notice to any products herein. ON Semiconductor makes no warranty, representation or guarantee regarding the suitability of its products for any particular purpose, nor does ON Semiconductor assume any liability arising out of the application or use of any product or circuit, and specifically disclaims any and all liability, including without limitation special, consequential or incidental damages. Buyer is responsible for its products and applications using ON Semiconductor products, including compliance with all laws, regulations and safety requirements or standards, regardless of any support or applications information provided by ON Semiconductor. "Typical" parameters which may be provided in ON Semiconductor data sheets and/or specifications can and do vary in different applications and actual performance may vary over time. All operating parameters, including "Typicals" must be validated for each customer application by customer's technical experts. ON Semiconductor does not convey any license under its patent rights nor the rights of others. ON Semiconductor products are not designed, intended, or authorized for use as a critical component in life support systems or any FDA Class 3 medical devices or medical devices with a same or similar classification in a foreign jurisdiction or any devices intended for implantation in the human body. Should Buyer purchase or use ON Semiconductor products for any such unintended or unauthorized application, Buyer shall indemnify and hold ON Semiconductor and its officers, employees, subsidiaries, affiliates, and distributors harmless against all claims, costs, damages, and expenses, and reasonable attorney fees arising out of, directly or indirectly, any claim of personal injury or death associated with such unintended or unauthorized use, even if such claim alleges that ON Semiconductor was negligent regarding the design or manufacture of the part. ON Semiconductor is an Equal Opportunity/Affirmative Action Employer. This literature is subject to all applicable copyright laws and is not for resale in any manner.

## PUBLICATION ORDERING INFORMATION

### LITERATURE FULFILLMENT:

Literature Distribution Center for ON Semiconductor  
19521 E. 32nd Pkwy, Aurora, Colorado 80011 USA  
**Phone:** 303-675-2175 or 800-344-3860 Toll Free USA/Canada  
**Fax:** 303-675-2176 or 800-344-3867 Toll Free USA/Canada  
**Email:** [orderlit@onsemi.com](mailto:orderlit@onsemi.com)

**N. American Technical Support:** 800-282-9855 Toll Free  
USA/Canada  
**Europe, Middle East and Africa Technical Support:**  
Phone: 421 33 790 2910  
**Japan Customer Focus Center**  
Phone: 81-3-5817-1050

**ON Semiconductor Website:** [www.onsemi.com](http://www.onsemi.com)  
**Order Literature:** <http://www.onsemi.com/orderlit>  
For additional information, please contact your local  
Sales Representative

# Mouser Electronics

Authorized Distributor

Click to View Pricing, Inventory, Delivery & Lifecycle Information:

[ON Semiconductor:](#)

[FNB40560](#)