

**GenX3™ 1200V  
IGBTs**
**IXGK82N120B3  
IXGX82N120B3**

$$V_{CES} = 1200V$$

$$I_{C110} = 82A$$

$$V_{CE(sat)} \leq 3.20V$$

 High-Speed Low-Vsat PT IGBTs  
for 3 - 20 kHz Switching

Symbol	Test Conditions	Maximum Ratings	
$V_{CES}$	$T_J = 25^\circ C$ to $150^\circ C$	1200	V
$V_{CGR}$	$T_J = 25^\circ C$ to $150^\circ C$ , $R_{GE} = 1M\Omega$	1200	V
$V_{GES}$	Continuous	$\pm 20$	V
$V_{GEM}$	Transient	$\pm 30$	V
$I_{C25}$	$T_C = 25^\circ C$ ( Chip Capability )	230	A
$I_{C110}$	$T_C = 110^\circ C$	82	A
$I_{LRMS}$	$T_C = 25^\circ C$ ( Lead RMS Limit )	120	A
$I_{CM}$	$T_C = 25^\circ C$ , 1ms	500	A
$I_A$	$T_C = 25^\circ C$	41	A
$E_{AS}$	$T_C = 25^\circ C$	750	mJ
<b>SSOA</b> <b>(RBSOA)</b>	$V_{GE} = 15V$ , $T_{VJ} = 125^\circ C$ , $R_G = 2\Omega$ Clamped Inductive Load	$I_{CM} = 164$ $V_{CE} \leq V_{CES}$	A
$P_C$	$T_C = 25^\circ C$	1250	W
$T_J$		-55 ... +150	$^\circ C$
$T_{JM}$		150	$^\circ C$
$T_{stg}$		-55 ... +150	$^\circ C$
$T_L$	Maximum Lead Temperature for Soldering	300	$^\circ C$
$T_{SOLD}$	1.6 mm (0.062 in.) from Case for 10	260	$^\circ C$
$M_d$	Mounting Torque ( IXGK )	1.13/10	Nm/lb.in.
$F_C$	Mounting Force ( IXGX )	20..120/4.5..14.6	N/lb.
<b>Weight</b>	TO-264	10	g
	PLUS247	6	g

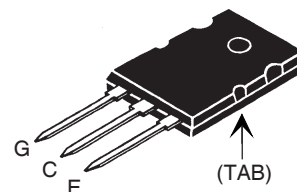
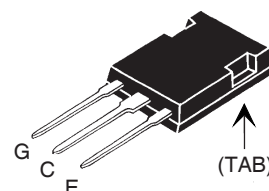
**TO-264 (IXGK)**

**PLUS247™ (IXGX)**

G = Gate                      E = Emitter  
C = Collector                TAB = Collector

**Features**

- Optimized for Low Conduction and Switching Losses
- Square RBSOA
- High Avalanche Capability
- International Standard Packages

**Advantages**

- High Power Density
- Low Gate Drive Requirement

**Applications**

- Power Inverters
- UPS
- SMPS
- PFC Circuits
- Welding Machines
- Lamp Ballasts

Symbol	Test Conditions ( $T_J = 25^\circ C$ , Unless Otherwise Specified)	Characteristic Values		
		Min.	Typ.	Max.
$BV_{CES}$	$I_C = 250\mu A$ , $V_{CE} = 0V$	1200		V
$V_{GE(th)}$	$I_C = 1mA$ , $V_{CE} = V_{GE}$	3.0		5.0 V
$I_{CES}$	$V_{CE} = V_{CES}$ , $V_{GE} = 0V$ $T_J = 125^\circ C$ , Note 1			50 $\mu A$ 5 mA
$I_{GES}$	$V_{CE} = 0V$ , $V_{GE} = \pm 20V$			$\pm 100$ nA
$V_{CE(sat)}$	$I_C = I_{C110}$ , $V_{GE} = 15V$ , Note 2 $T_J = 125^\circ C$	2.70 2.64		3.20 V V

Symbol	Test Conditions ( $T_J = 25^\circ\text{C}$ , Unless Otherwise Specified)	Characteristic Values				
		Min.	Typ.	Max.		
$g_{fs}$	$I_C = 60\text{A}, V_{CE} = 10\text{V}$ , Note 2	35	60	S		
$C_{ies}$	$V_{CE} = 25\text{V}, V_{GE} = 0\text{V}, f = 1\text{MHz}$		7900	pF		
$C_{oes}$			640	pF		
$C_{res}$			170	pF		
$Q_{g(on)}$	$I_C = I_{C110}, V_{GE} = 15\text{V}, V_{CE} = 0.5 \cdot V_{CES}$		350	nC		
$Q_{ge}$			50	nC		
$Q_{gc}$			150	nC		
$t_{d(on)}$	<b>Inductive load, <math>T_J = 25^\circ\text{C}</math></b> $I_C = 80\text{A}, V_{GE} = 15\text{V}$		30	ns		
$t_{ri}$			77	ns		
$E_{on}$			5.0	mJ		
$t_{d(off)}$	Note 3	$V_{CE} = 0.5 \cdot V_{CES}, R_G = 2\Omega$		210	ns	
$t_{fi}$				100	180	ns
$E_{off}$				3.3	6.2	mJ
$t_{d(on)}$	<b>Inductive load, <math>T_J = 125^\circ\text{C}</math></b> $I_C = 80\text{A}, V_{GE} = 15\text{V}$		32	ns		
$t_{ri}$			80	ns		
$E_{on}$			6.8	mJ		
$t_{d(off)}$	Note 3	$V_{CE} = 0.5 \cdot V_{CES}, R_G = 2\Omega$		240	ns	
$t_{fi}$				520	ns	
$E_{off}$				7.1	mJ	
$R_{thJC}$				0.10 $^\circ\text{C/W}$		
$R_{thCK}$			0.15	$^\circ\text{C/W}$		

**Notes:**

1. Part must be heatsunk for high-temp  $I_{ces}$  measurement.
2. Pulse test,  $t \leq 300\mu\text{s}$ ; duty cycle,  $d \leq 2\%$ .
3. Switching times & energy losses may increase for higher  $V_{CE}(\text{Clamp})$ ,  $T_J$  or  $R_G$ .

**ADVANCE TECHNICAL INFORMATION**

The product presented herein is under development. The Technical Specifications offered are derived from a subjective evaluation of the design, based upon prior knowledge and experience, and constitute a "considered reflection" of the anticipated result. IXYS reserves the right to change limits, test conditions, and dimensions without notice.

**TO-264 (IXGK) Outline**

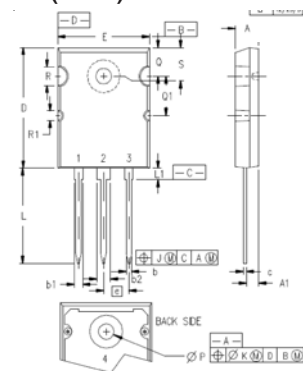

- 1 - GATE  
2, 4 - DRAIN (COLLECTOR)  
3 - SOURCE (EMITTER)

SYM	INCHES		MILLIMETERS	
	MIN	MAX	MIN	MAX
A	.185	.209	4.70	5.31
A1	.102	.118	2.59	3.00
b	.037	.055	0.94	1.40
b1	.087	.102	2.21	2.59
b2	.110	.126	2.79	3.20
c	.017	.029	0.43	0.74
D	1.007	1.047	25.58	26.59
E	.760	.799	19.30	20.29
e	.215BSC		5.46 BSC	
J	.000	.010	0.00	0.25
K	.000	.010	0.00	0.25
L	.779	.842	19.79	21.39
L1	.087	.102	2.21	2.59
ØP	.122	.138	3.10	3.51
Q	.240	.256	6.10	6.50
Q1	.330	.346	8.38	8.79
ØR	.155	.187	3.94	4.75
ØR1	.085	.093	2.16	2.36
S	.243	.253	6.17	6.43

**PLUS247™ (IXGX) Outline**

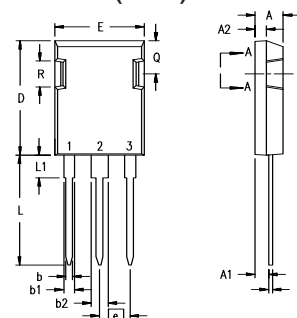

- Terminals: 1 - Gate  
2 - Drain (Collector)  
3 - Source (Emitter)

Dim.	Millimeter		Inches	
	Min.	Max.	Min.	Max.
A	4.83	5.21	.190	.205
A <sub>1</sub>	2.29	2.54	.090	.100
A <sub>2</sub>	1.91	2.16	.075	.085
b	1.14	1.40	.045	.055
b <sub>1</sub>	1.91	2.13	.075	.084
b <sub>2</sub>	2.92	3.12	.115	.123
C	0.61	0.80	.024	.031
D	20.80	21.34	.819	.840
E	15.75	16.13	.620	.635
e	5.45 BSC		.215 BSC	
L	19.81	20.32	.780	.800
L1	3.81	4.32	.150	.170
Q	5.59	6.20	.220	0.244
R	4.32	4.83	.170	.190

IXYS Reserves the Right to Change Limits, Test Conditions, and Dimensions.

IXYS MOSFETs and IGBTs are covered by one or more of the following U.S. patents:	4,835,592	4,931,844	5,049,961	5,237,481	6,162,665	6,404,065 B1	6,683,344	6,727,585	7,005,734 B2	7,157,338B2
	4,850,072	5,017,508	5,063,307	5,381,025	6,259,123 B1	6,534,343	6,710,405 B2	6,759,692	7,063,975 B2	
	4,881,106	5,034,796	5,187,117	5,486,715	6,306,728 B1	6,583,505	6,710,463	6,771,478 B2	7,071,537	

**Fig. 1. Output Characteristics @ 25°C**

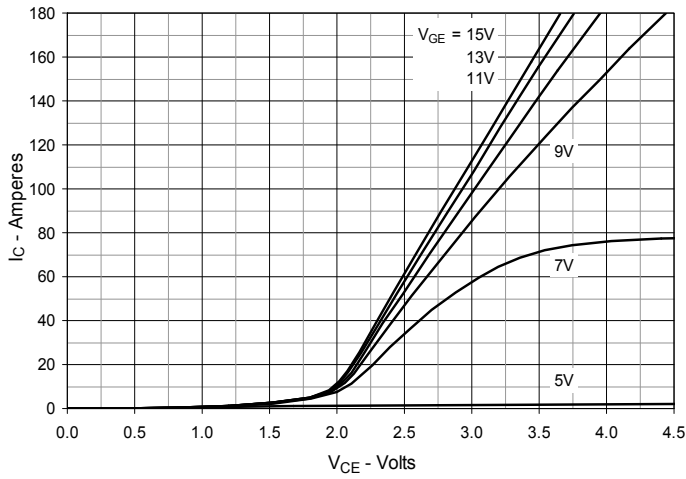

**Fig. 2. Extended Output Characteristics @ 25°C**

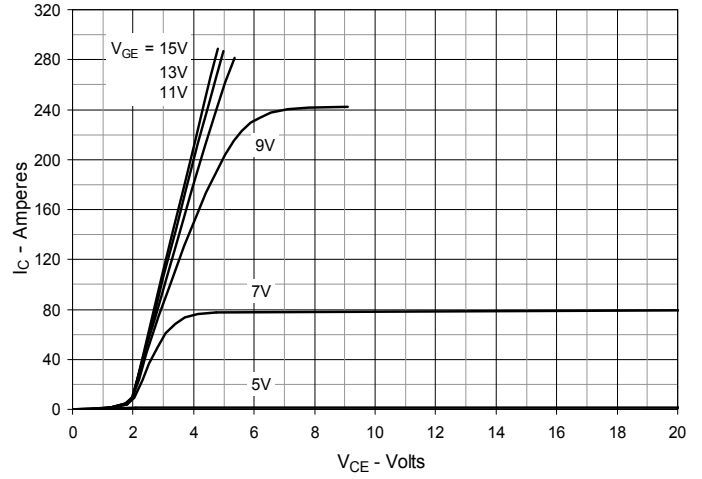

**Fig. 3. Output Characteristics @ 125°C**

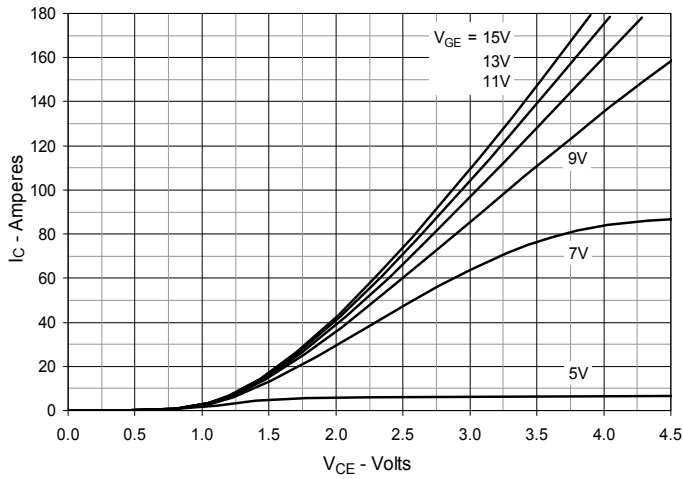

**Fig. 4. Dependence of  $V_{CE(sat)}$  on Junction Temperature**

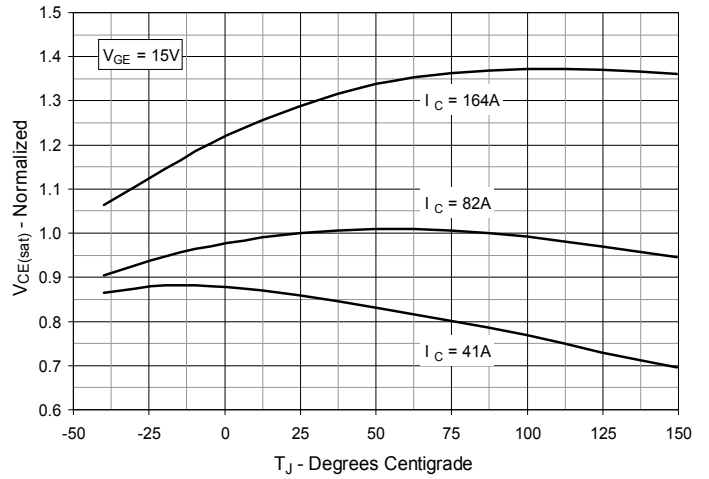

**Fig. 5. Collector-to-Emitter Voltage vs. Gate-to-Emitter Voltage**

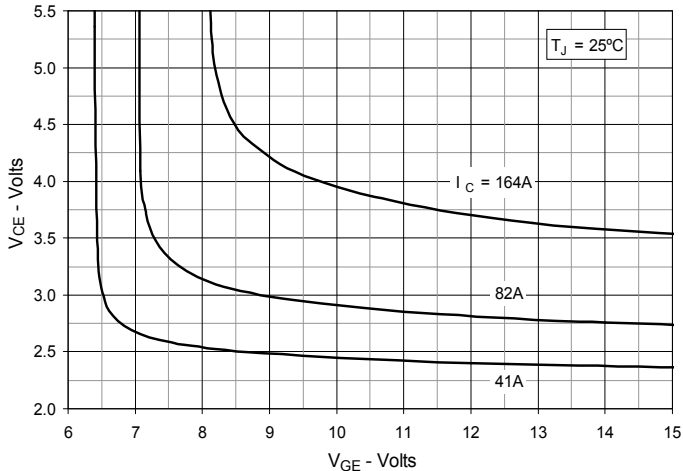

**Fig. 6. Input Admittance**

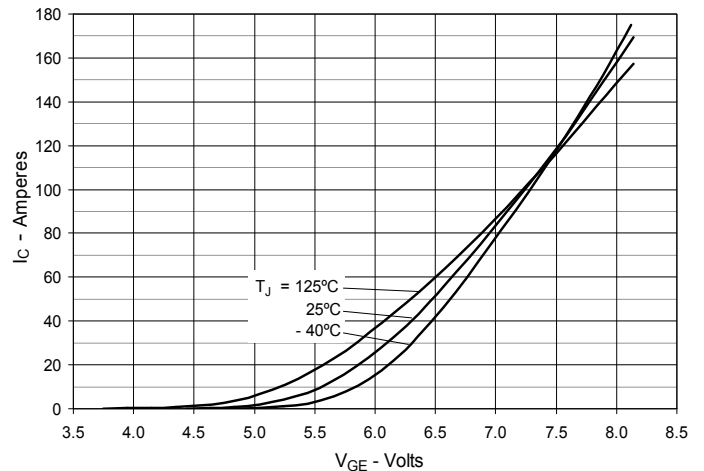

Fig. 7. Transconductance

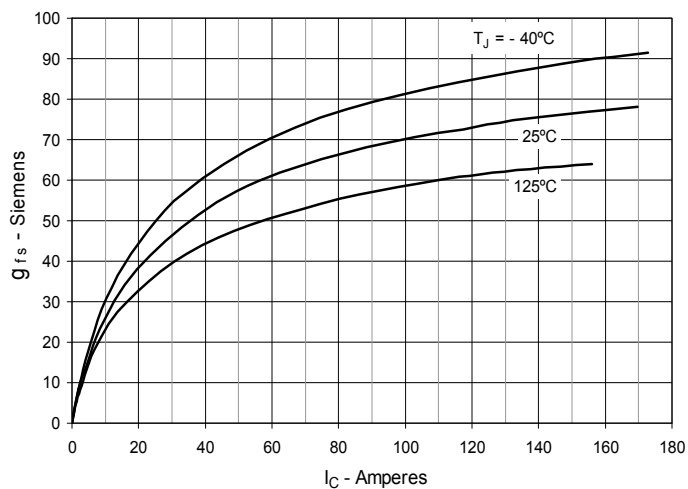

Fig. 8. Gate Charge

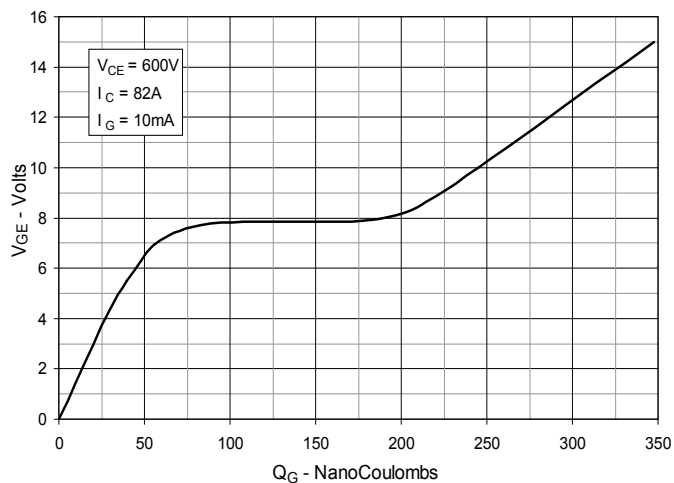

Fig. 9. Capacitance

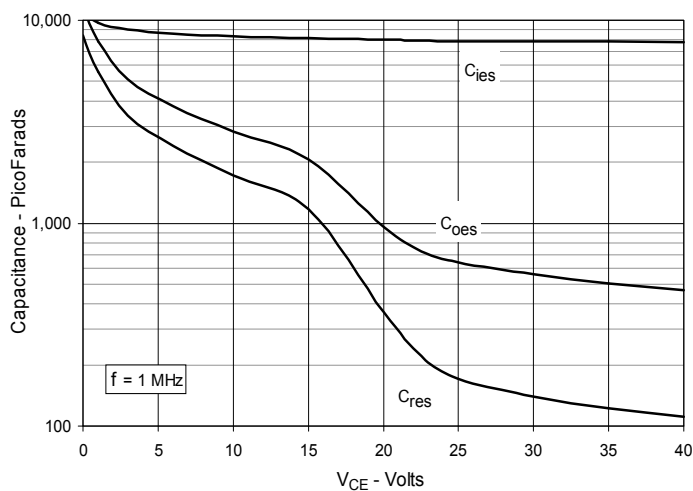

Fig. 10. Reverse-Bias Safe Operating Area

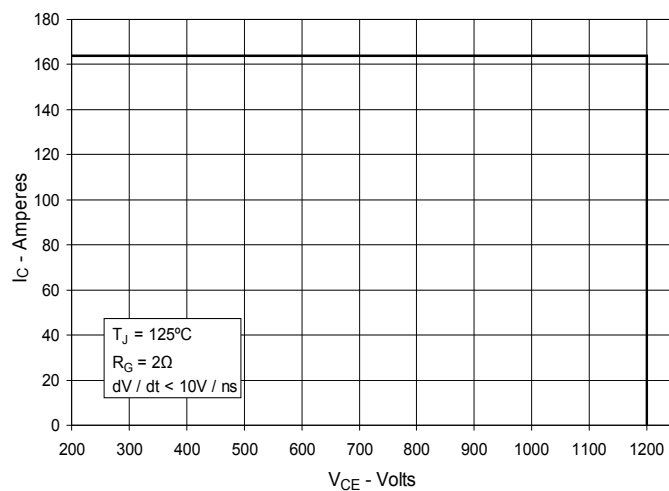
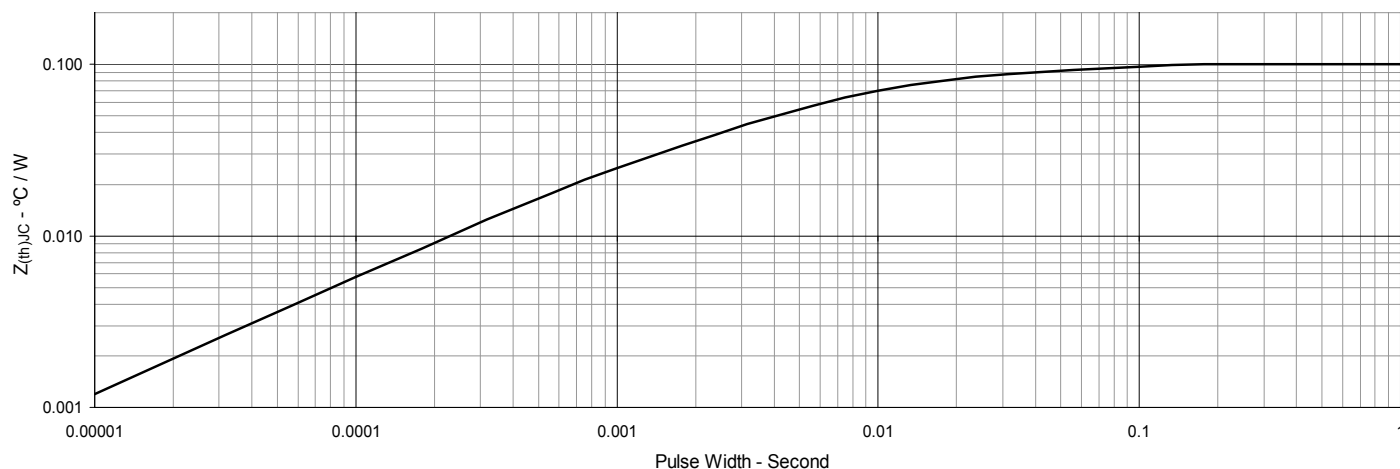
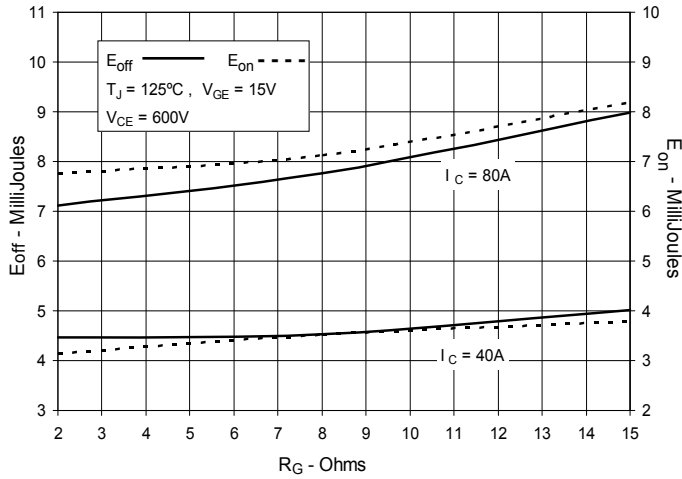

Fig. 11. Maximum Transient Thermal Impedance



**Fig. 12. Inductive Switching  
Energy Loss vs. Gate Resistance**



**Fig. 13. Inductive Switching  
Energy Loss vs. Collector Current**

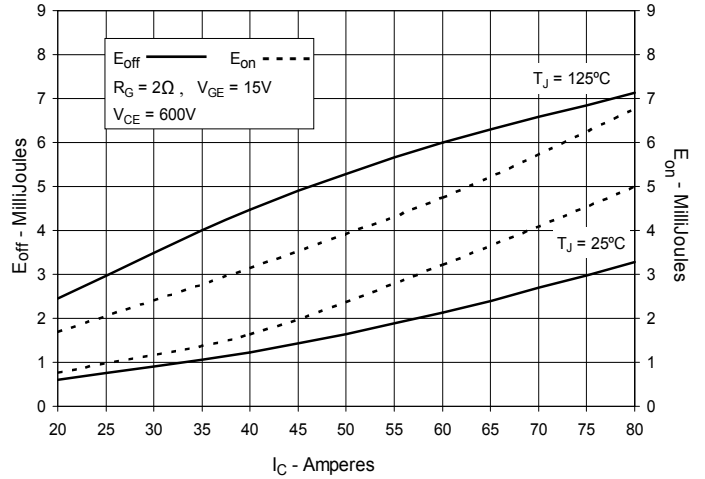

**Fig. 14. Inductive Switching  
Energy Loss vs. Junction Temperature**

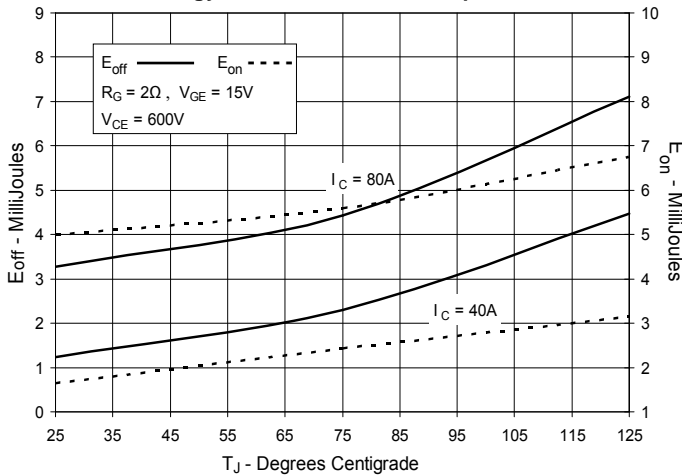

**Fig. 15. Inductive Turn-off  
Switching Times vs. Gate Resistance**

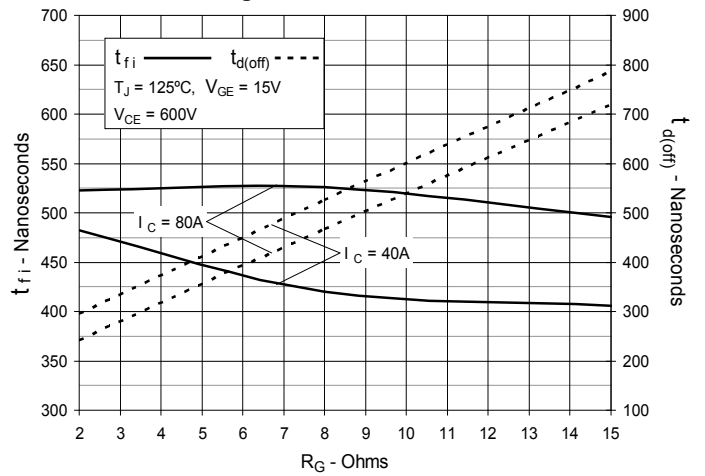

**Fig. 16. Inductive Turn-off  
Switching Times vs. Collector Current**

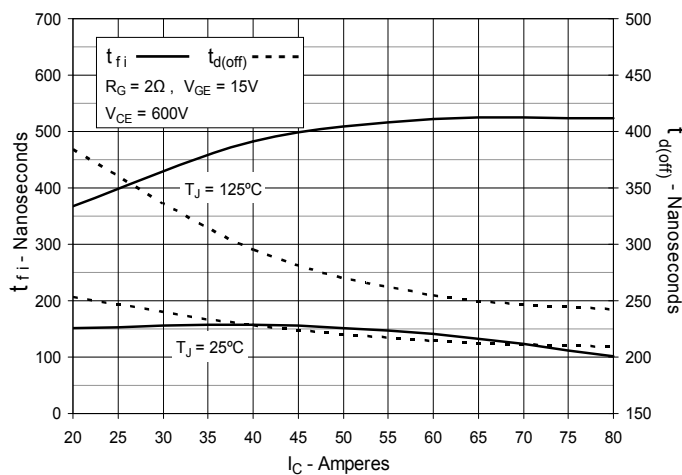

**Fig. 17. Inductive Turn-off  
Switching Times vs. Junction Temperature**

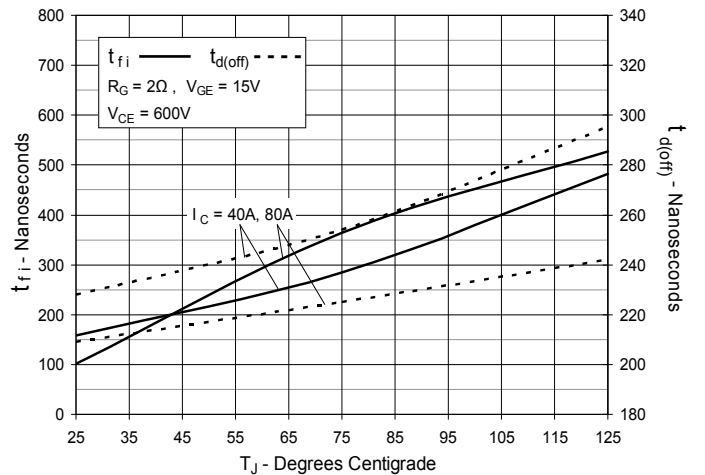

**Fig. 18. Inductive Turn-on  
Switching Times vs. Gate Resistance**

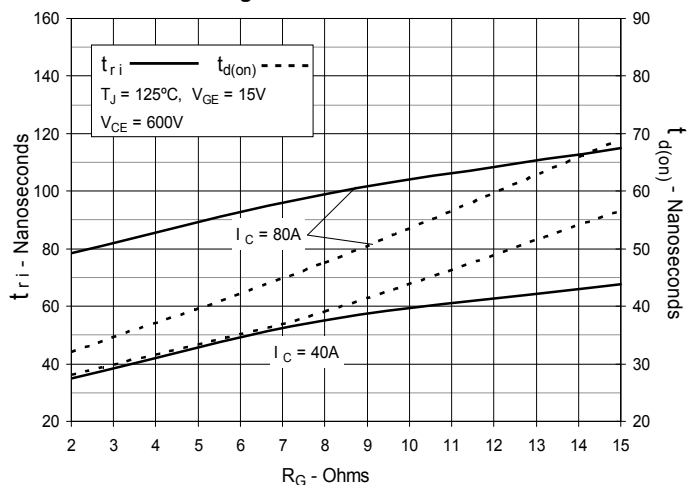

**Fig. 19. Inductive Turn-on  
Switching Times vs. Collector Current**

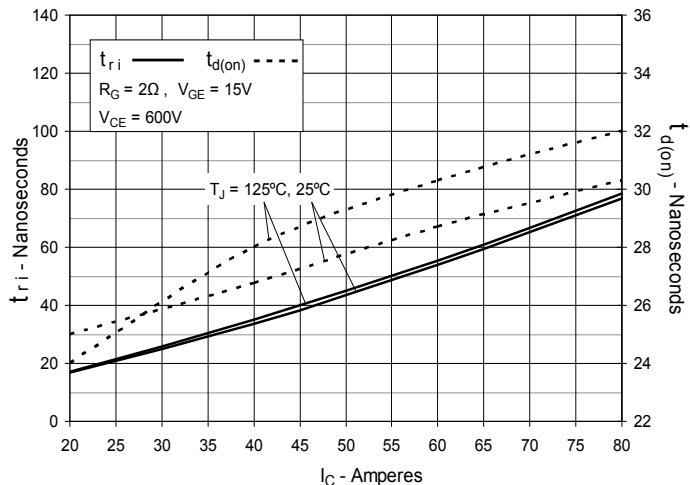

**Fig. 20. Inductive Turn-on  
Switching Times vs. Junction Temperature**

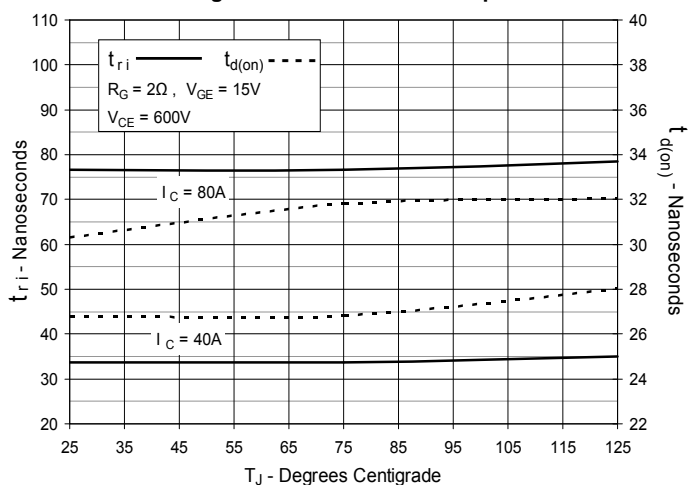

# Mouser Electronics

Authorized Distributor

Click to View Pricing, Inventory, Delivery & Lifecycle Information:

[IXYS:](#)

[IXGX82N120B3](#)