

THIS DRAWING IS UNPUBLISHED. RELEASED FOR PUBLICATION
 © COPYRIGHT BY TYCO ELECTRONICS CORPORATION. ALL INTERNATIONAL RIGHTS RESERVED.

LOC	DIST	REVISIONS					
G	14	P	LTR	DESCRIPTION	DATE	DWN	APVD
		J1		REVISED PER ECO-11-002228	11FEB11	HMR	DR

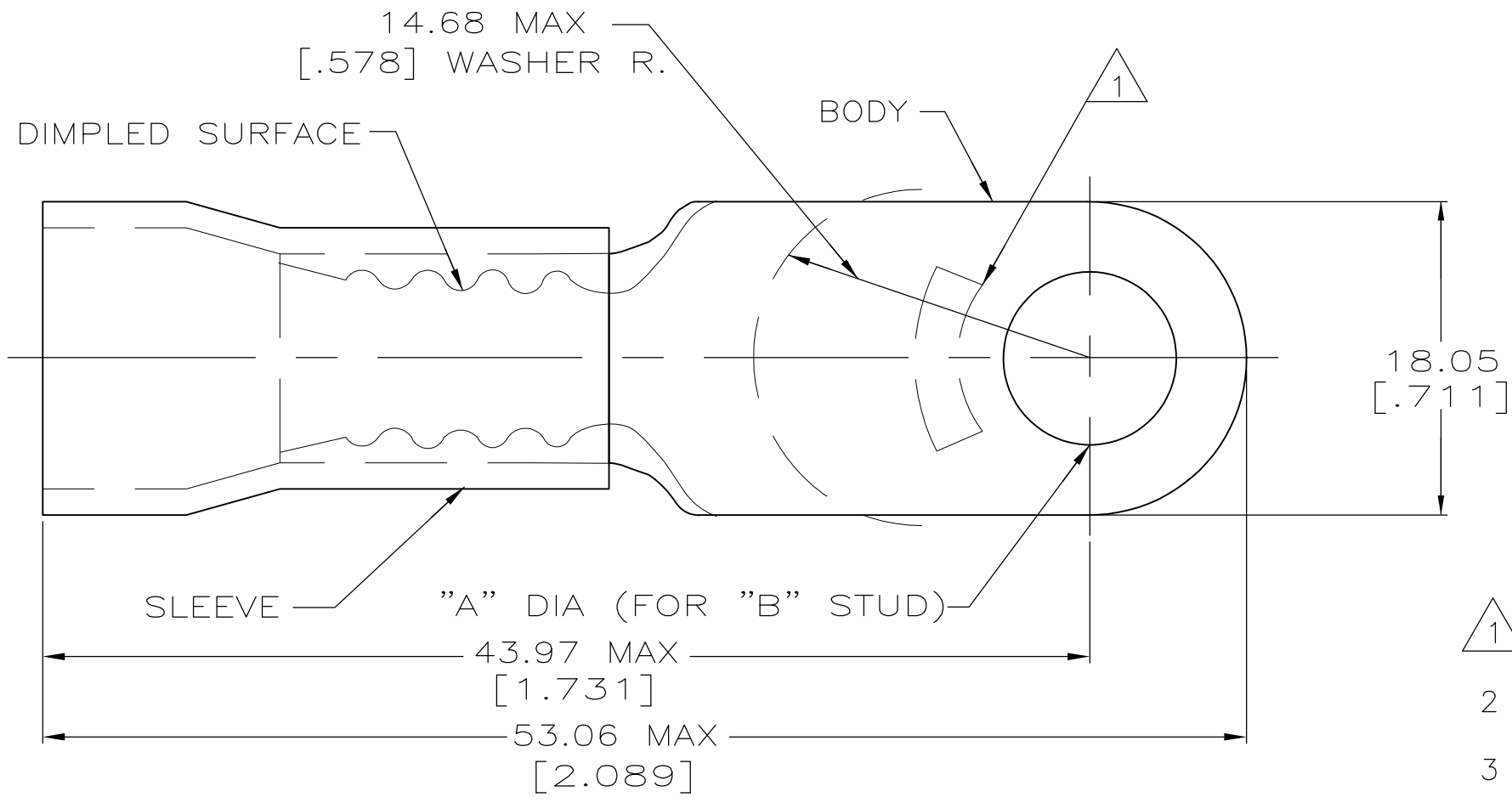

AMP WIRE RANGE	AW FILE E13288	LR7189 Certified
2 AWG STRANDED	2 AWG STRANDED	2 AWG STRANDED

- 1 STAMP AMP 2* LOCATE APPROX AS SHOWN
- 2 TONGUE MATERIAL THK 1.45±0.08 [.057±.003]
- 3 SEE TABLE FOR WIRE INSULATION DIA MAX

OBSOLETE				100	LOOSE PC, BOX SPL	8-52044-5
OBSOLETE				50	LOOSE PC, BOX	8-52044-2
	14.22 [.560]	3/8	9.91±0.13 .390±.005	50	LOOSE PC	52044-5
		5/16	8.33±0.13 .328±.005			52044-4
	16.05 [.632]	3/8	9.91±0.13 .390±.005	50	LOOSE PC	52044-2
		5/16	8.33±0.13 .328±.005			52044-1
	WIRE INSULATION DIA	"B"	"A"	QTY	PACKAGE TYPE	PART NO

AMP INCORPORATED
CUSTOMER SERVICE SYSTEMS

FOR ADDITIONAL PRODUCT INFORMATION OR COPIES OF DRAWINGS AND TECHNICAL DOCUMENTS: PRODUCT INFORMATION CENTER 1-800-522-6752

FOR APPLICATION TOOLING INFORMATION: TOOLING ASSISTANCE CENTER 1-800-722-1111

FOR ORDER ENTRY: 1-800-526-5142

MAX RECOMMENDED OPERATING TEMPERATURE: 105° C

VOLTAGE RATING: 600 V MAX

CIRCULAR MIL AREA: 26.65-42.41mm² [52,600-83,700] STRANDED

THIS DRAWING IS A CONTROLLED DOCUMENT FOR AMP INCORPORATED. IT IS SUBJECT TO CHANGE AND THE CONTROLLING ENGINEERING ORGANIZATION SHOULD BE CONTACTED FOR THE LATEST REVISION.

THIS DRAWING IS A CONTROLLED DOCUMENT.

DIMENSIONS: mm [INCHES]

TOLERANCES UNLESS OTHERWISE SPECIFIED:

0 PLC	± -
1 PLC	± -
2 PLC	± 0.20 [.008]
3 PLC	± -
4 PLC	± -
ANGLES	± -

MATERIAL: COPPER PER ASTM B-152 PVC, COLOR: RED

FINISH: TIN PLATE PER ASTM-B545

DWN: S.S. GOULDEN 9-28-93

CHK: R. HERSEY 9-28-93

APVD: B. BARE 9-28-93

PRODUCT SPEC: NOT AVAILABLE

APPLICATION SPEC: 114-2161

WEIGHT: -

Tyco Electronics Tyco Electronics Corporation Harrisburg, PA 17105-3608

NAME: TERMINAL, RING TONGUE, PLASTI GRIP, WIRE SIZE: 2 AWG

SIZE: A3 CAGE CODE: 00779 DRAWING NO: C-52044 RESTRICTED TO: -

CUSTOMER DRAWING SCALE: 4:1 SHEET: 1 OF 1 REV: J1

Mouser Electronics

Authorized Distributor

Click to View Pricing, Inventory, Delivery & Lifecycle Information:

[TE Connectivity:](#)

[52044-4](#)