

Mutter / nut

Bolzen / bolt

Gewinde / thread
M3 / #4-40

ohne / without

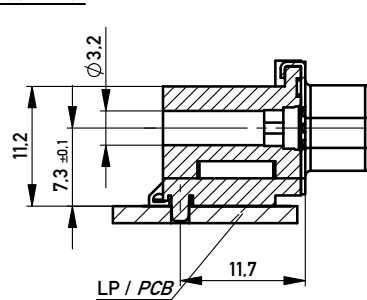
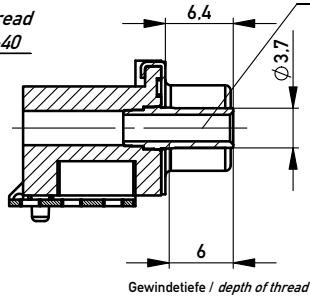
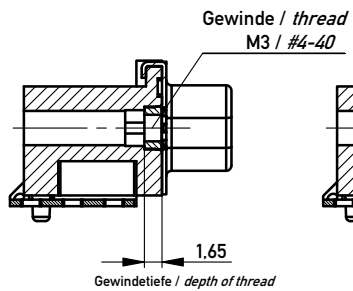

Anschlussbereich verzinnt
terminal area tin plating

Koplanarität der Anschlüsse ≤ 0.1 mm
coplanarity area of termination ≤ 0.1 mm

Anforderungsstufe: 2
class: 2

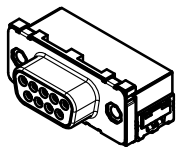

Verpackt in Tray
Verpackungseinheit 32 Stück
tray packaging
packaging unit 32 pcs

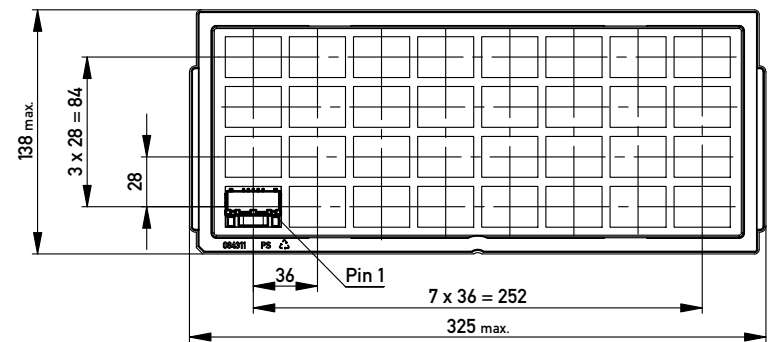

Sonstige Angaben siehe Zeichnung 204629 / additional indications according to drawing 204629

Verpackt in Gurtverpackung - Tape on Reel Packaging
Verpackungseinheit: 75 Stück - Packaging unit: 75 pcs

Abspulrichtung - Reel off Direction

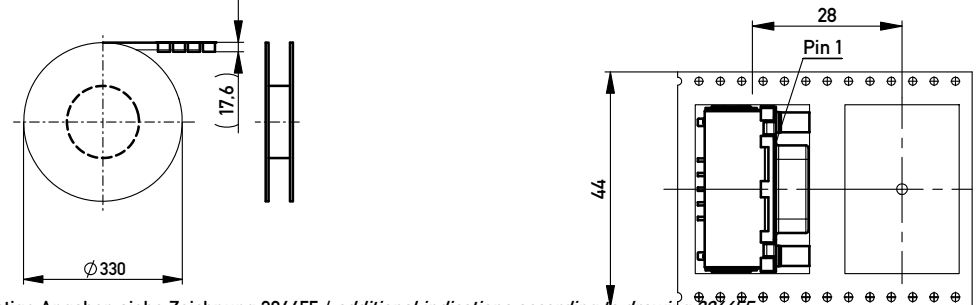

Sonstige Angaben siehe Zeichnung 204655 / additional indications according to drawing 204655

Layoutvorschlag
recommended layout

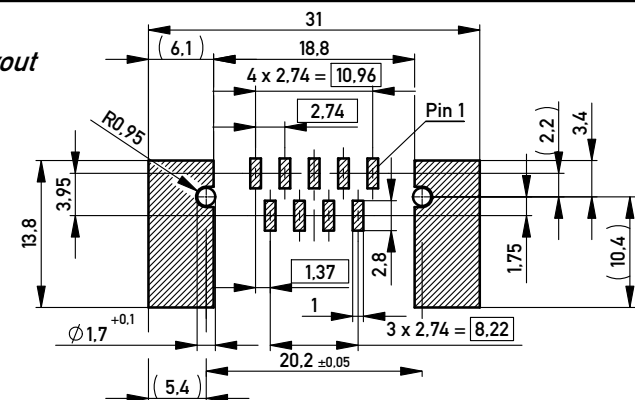

Fehlende Masse und Angaben siehe DIN 41652 / Missing information and dimensions according to DIN 41652
Sonstige Angaben siehe Fertigungsunterlagen / Additional indications according to production documentation

234939	174440	Ø3.2			
174988	154238			#4-40	
	154237			M3	
214560	154236	#4-40			
	154235	M3			
Ident-Nr. part-no. Gurt tape on reel	Ident-Nr. part-no. Tray tray	ohne without	Mutter nut	Bolzen bolt	Bemerkung remark

Information: All rights reserved. Only for Information. To ensure that this is the latest version of this drawing, please contact one of the ERNI companies before using.	Tolerances	Scale 2:1 All Dimensions in mm	Designation TMC-S-09-SMD-Standard-BA8 <i>TMC-S-09-SMD-Standard-BA8</i>
	Subject to modification without prior notice. Drawing will not be updated.		
Copyright by ERNI GmbH Proprietary notice pursuant to ISO 9006 to be observed.	www.ERNI.com	144839	I A3
Index	Date 21.11.2011	Class	TMCS

Mouser Electronics

Authorized Distributor

Click to View Pricing, Inventory, Delivery & Lifecycle Information:

[ERNI Electronics:](#)

[154236](#)