

Ultrafast Plastic Rectifier

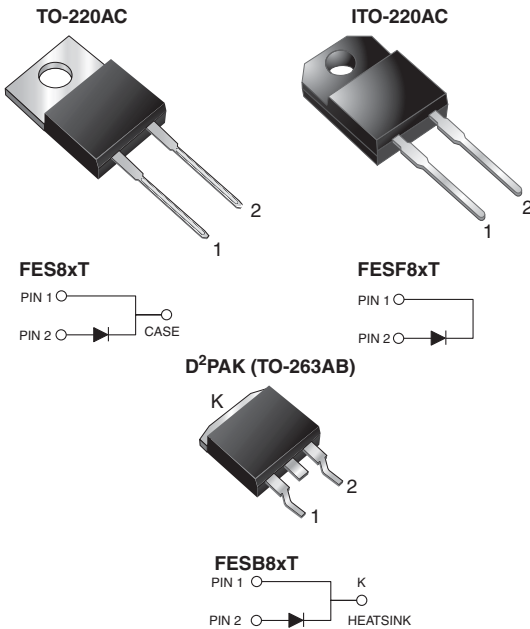

FEATURES

- Power pack
- Glass passivated pellet chip junction
- Ultrafast recovery time
- Low switching losses, high efficiency
- Low leakage current
- High forward surge capability
- Meets MSL level 1, per J-STD-020, LF maximum peak of 245 °C (for TO-263AB package)
- Solder dip 275 °C max., 10 s per JESD 22-B106 (for TO-220AC and ITO-220AC package)
- AEC-Q101 qualified (for ITO-220AC and TO-263AB package)
- Material categorization: for definitions of compliance please see www.vishay.com/doc?99912

RoHS
COMPLIANT

TYPICAL APPLICATIONS

For use in high frequency rectifier of switching mode power supplies, inverters, freewheeling diodes, DC/DC converters, and other power switching application.

DESIGN SUPPORT TOOLS

[click logo to get started](#)
3D
Models
Available

PRIMARY CHARACTERISTICS

$I_{F(AV)}$	8.0 A
V_{RRM}	50 V to 600 V
I_{FSM}	125 A
t_{rr}	35 ns, 50 ns
V_F	0.95 V, 1.30 V, 1.50 V
T_J max.	150 °C
Package	TO-220AC, ITO-220AC, D²PAK (TO-263AB)
Circuit configurations	Single

MECHANICAL DATA

Case: TO-220AC, ITO-220AC, D²PAK (TO-263AB)

Molding compound meets UL 94V-0 flammability rating
 Base P/N-E3 - RoHS-compliant, commercial grade
 Base P/NHE3 - RoHS-compliant, AEC-Q101 qualified

Terminals: matte tin plated leads, solderable per J-STD-002 and JESD22-B102

E3 suffix meets JESD 201 class 1A whisker test, HE3 suffix meets JESD 201 class 2 whisker test

Polarity: as marked

Mounting Torque: 10 in-lbs max.

MAXIMUM RATINGS ($T_C = 25$ °C unless otherwise noted)

PARAMETER	SYMBOL	FES 8AT	FES 8BT	FES 8CT	FES 8DT	FES 8FT	FES 8GT	FES 8HT	FES 8JT	UNIT
Max. repetitive peak reverse voltage	V_{RRM}	50	100	150	200	300	400	500	600	V
Max. RMS voltage	V_{RMS}	35	70	105	140	210	280	350	420	V
Max. DC blocking voltage	V_{DC}	50	100	150	200	300	400	500	600	V
Max. average forward rectified current at $T_C = 100$ °C	$I_{F(AV)}$	8.0								A
Peak forward surge current 8.3 ms single half sine-wave superimposed on rated load	I_{FSM}	125								A
Operating storage and temperature range	T_J, T_{STG}	-55 to +150								°C
Isolation voltage (ITO-220AC only) from terminal to heatsink $t = 1$ min	V_{AC}	1500								V



ELECTRICAL CHARACTERISTICS (T _C = 25 °C unless otherwise noted)												
PARAMETER	TEST CONDITIONS		SYMBOL	FES8AT	FES8BT	FES8CT	FES8DT	FES8FT	FES8GT	FES8HT	FES8JT	UNIT
Max. instantaneous forward voltage ⁽¹⁾	8.0 A		V _F	0.95				1.3		1.5		V
Max. DC reverse current at rated DC blocking voltage		T _C = 25 °C	I _R	10								μA
		T _C = 100 °C		500								
Max. reverse recovery time	I _F = 0.5 A, I _R = 1.0 A I _{rr} = 0.25 A		t _{rr}	35				50			ns	
Typical junction capacitance	4.0 V, 1 MHz		C _J	85						50		pF

Note

⁽¹⁾ Pulse test: 300 μs pulse width, 1 % duty cycle

THERMAL CHARACTERISTICS (T _C = 25 °C unless otherwise noted)						
PARAMETER	SYMBOL		FES	FESF	FESB	UNIT
Typical thermal resistance from junction to case	R _{θJC}		2.2	5.0	2.2	°C/W

ORDERING INFORMATION (Example)					
PACKAGE	PREFERRED P/N	UNIT WEIGHT (g)	PACKAGE CODE	BASE QUANTITY	DELIVERY MODE
TO-220AC	FES8JT-E3/45	1.80	45	50/tube	Tube
ITO-220AC	FESF8JT-E3/45	1.85	45	50/tube	Tube
TO-263AB	FESB8JT-E3/45	1.33	45	50/tube	Tube
TO-263AB	FESB8JT-E3/81	1.33	81	800/reel	Tape and reel
ITO-220AC	FESF8JTJE3/45 ⁽¹⁾	1.85	45	50/tube	Tube
TO-263AB	FESB8JTJE3/45 ⁽¹⁾	1.33	45	50/tube	Tube
TO-263AB	FESB8JTJE3/81 ⁽¹⁾	1.33	81	800/reel	Tape and reel

Note

⁽¹⁾ AEC-Q101 qualified, available in ITO-220AC and TO-263AB package



RATINGS AND CHARACTERISTICS CURVES ($T_C = 25\text{ }^\circ\text{C}$ unless otherwise noted)

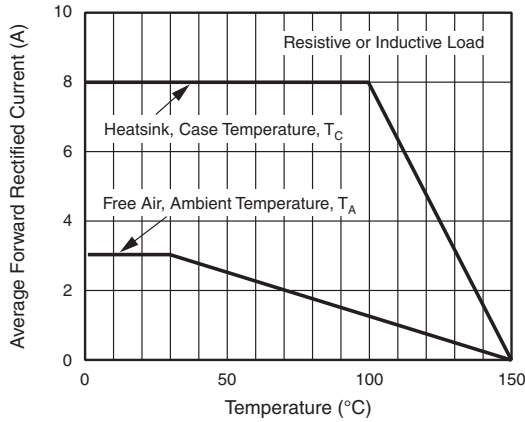

Fig. 1 - Max. Forward Current Derating Curve

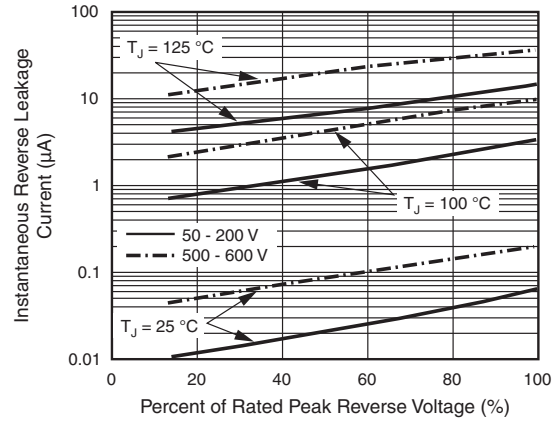

Fig. 4 - Typical Reverse Leakage Characteristics

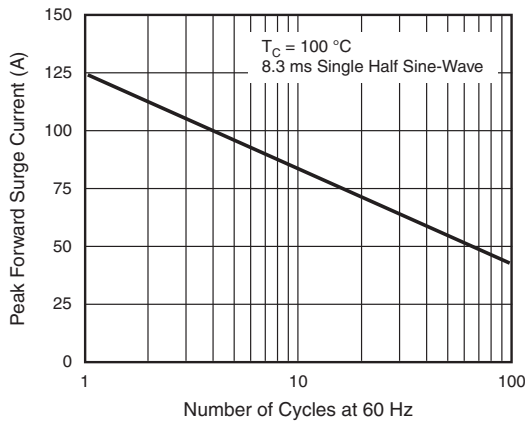

Fig. 2 - Max. Non-Repetitive Peak Forward Surge Current

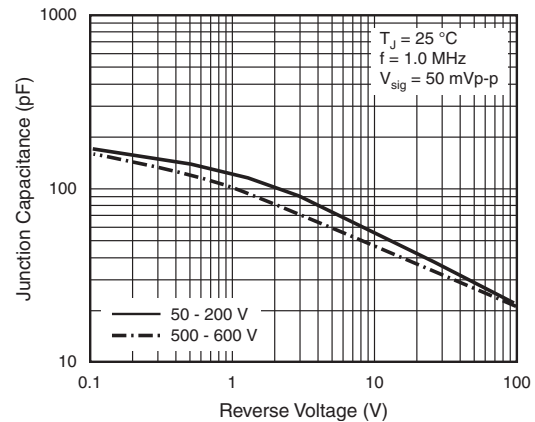

Fig. 5 - Typical Junction Capacitance

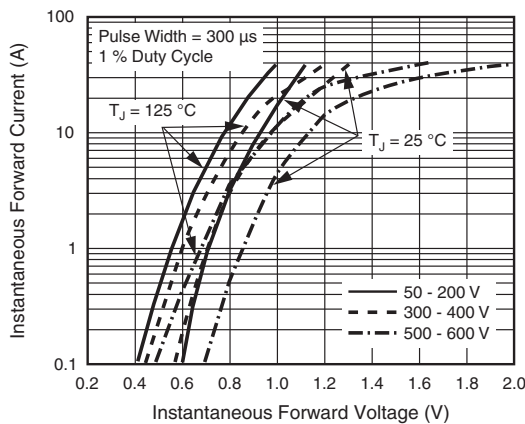
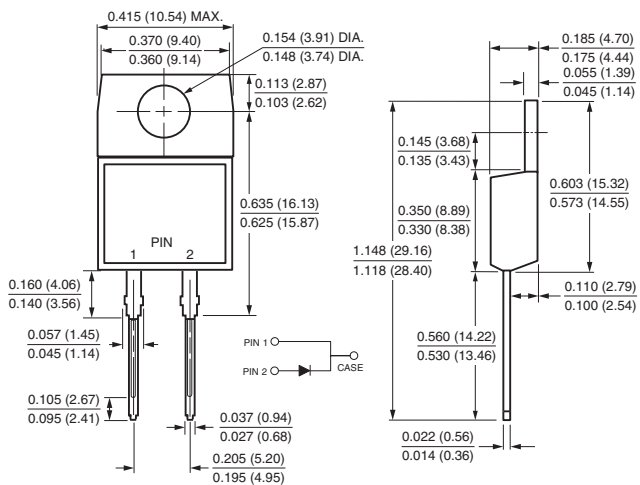

Fig. 3 - Typical Instantaneous Forward Characteristics



PACKAGE OUTLINE DIMENSIONS in inches (millimeters)

TO-220AC



ITO-220AC

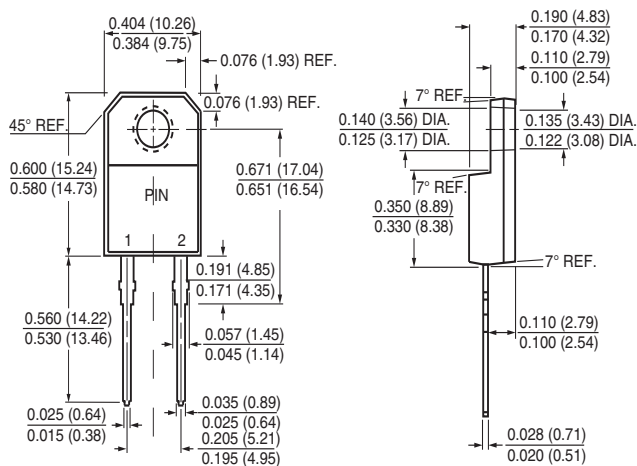

D²PAK (TO-263AB)

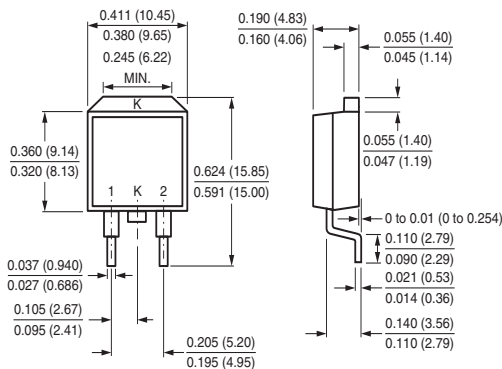

Mounting Pad Layout

