

3rd. Over Tone Small Sized Quartz Crystal Oscillator

GENERAL DESCRIPTION

The NJU6376 series is a C-MOS 3rd. over tone quartz crystal oscillator that consists of an oscillation amplifier and 3-state output buffer.

The type numbers are classed into four versions G, H, J and K according to their oscillation frequency range shown in the line-up table.

The oscillation amplifier is realized very low stand-by current using NAND circuit.

The 3-state output buffer is C-MOS compatible

Furthermore, the package is small-sized MTP-6.

PACKAGE OUTLINE

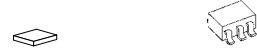

NJU6376XC-C NJU6376XF1

FEATURES

- Operating Voltage 2.2 to 5.5V
- Oscillation Frequency Range (See Line-up Table)
- Low Operating Current
- High Fan-out $I_{OH}/I_{OL}=4mA$ @2.5V
- Oscillation Stop and Output Stand-by Function
- 3-State Output Buffer
- Oscillation Capacitors C_g and C_d on-chip
- Package Outline Chip/MTP-6
- C-MOS Technology

PAD LOCATION/PIN CONFIGURATION

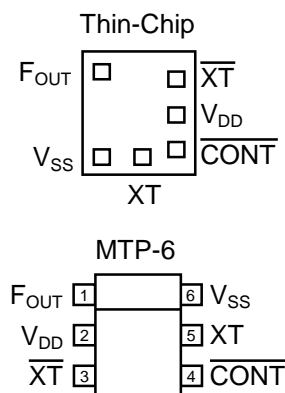

LINE-UP TABLE

Type No.	Recommended Oscillation Frequency Range	Output Frequency	C _g /C _d
NJU6376	G 30 to 40MHz	f ₀	18/18pF
	H 40 to 50MHz		16/16pF
	J 50 to 60MHz		11/11pF
	K 60 to 75MHz		10/10pF

COORDINATION

Pad Name	X	Y
F _{OUT}	-220	245
V _{SS}	-205	-230
XT	13	-230
CONT	205	-191
V _{DD}	205	0
XT	205	191

Starting Point: Chip Center Unit[μm]
 Chip Size: 0.70x0.75mm
 Thin-Chip Thickness(-C): 260±20μm
 Pad Size: 90x90μm

BLOCK DIAGRAM

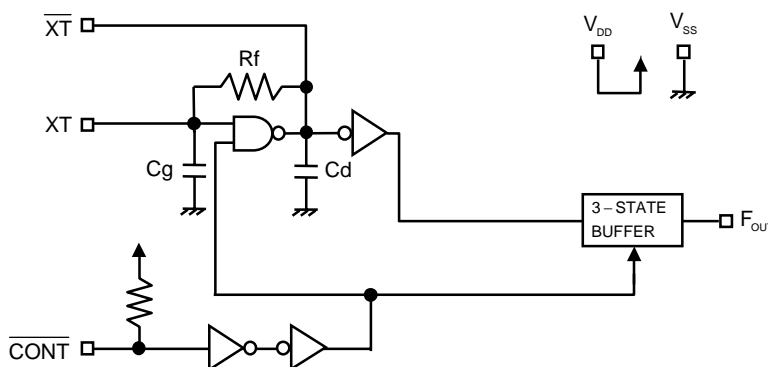

■TERMINAL DESCRIPTION

SYMBOL	FUNCTION	
$\overline{\text{CONT}}$	Oscillation and 3-state Output Buffer Control	
	$\overline{\text{CONT}}$	F_{OUT}
	H or OPEN	Output frequency f_0 (Note1)
	L	Oscillation Stop and High impedance Output
$\overline{\text{XT}}$	Quartz Crystal Connecting Terminals	
XT		
V_{SS}	$V_{\text{SS}}=0\text{V}$	
F_{OUT}	Frequency Output	
V_{DD}	$V_{\text{DD}}=2.5\text{V}/3.0\text{V}/5.0\text{V}$	

Note1) Refer to the line-up table.

■ABSOLUTE MAXIMUM RATINGS

($T_a=25^\circ\text{C}$)

PARAMETER	SYMBOL	RATING	UNIT
Supply Voltage	V_{DD}	-0.5 to +7.0	V
Input Voltage	V_{IN}	$V_{\text{SS}}-0.5$ to $V_{\text{DD}}+0.5$	V
Output Voltage	V_{O}	-0.5 to $V_{\text{DD}}+0.5$	V
Input Current	I_{IN}	± 10	mA
Output Current	I_{O}	± 25	mA
Power Dissipation Note4)	P_{D}	200(MTP-6)	mW
Operating Temperature Range	T_{opr}	-40 to +85	$^\circ\text{C}$
Storage Temperature Range	T_{stg}	-55 to +125	$^\circ\text{C}$

Note2) If the supply voltage(V_{DD}) is less than 7.0V, the input voltage must not over the V_{DD} level though 7.0V is limit specified.

Note3) Decoupling capacitor should be connected between V_{DD} and V_{SS} due to the stabilized operation for the circuit.

Note4) The power dissipation is the maximum value at only the package.

■ ELECTRICAL CHARACTERISTICS

(Ta=25°C)

PARAMETER	SYMBOL	CONDITIONS	MIN	TYP	MAX	UNIT
Operating Voltage	V _{DD}		2.2		5.5	V

(V_{DD}=2.5V, Ta=25°C)

PARAMETER	SYMBOL	CONDITIONS	MIN	TYP	MAX	UNIT
Operating Current	I _{DD}	G version, fosc=40MHz, C _L =15pF			6	mA
		H version, fosc=50MHz, C _L =15pF			9	
		J version, fosc=60MHz, C _L =15pF			9	
		K version, fosc=75MHz, C _L =15pF			10	
Oscillation Stopping Current	I _{STB}	$\overline{\text{CONT}} = V_{SS}$, No load		2	5	uA
Stand-by Current	I _{st}	$\overline{\text{CONT}} = \text{XT} = V_{SS}$, No load Note5)			1	uA
Input Voltage	V _{IH}		2.0		2.5	V
	V _{IL}		0		0.5	V
Output Current	I _{OH}	V _{OH} =2.2V	4			mA
	I _{OL}	V _{OL} =0.3V	4			mA
Input Current	I _{IN}	$\overline{\text{CONT}} = 0.8V_{DD}$		7.5	12.0	uA
		$\overline{\text{CONT}} = 0.2V_{DD}$		1.2	2.0	uA
3-state Off Leakage Current	I _{oz}	$\overline{\text{CONT}} = V_{SS}$, F _{OUT} = V _{DD} or V _{SS}			±0.1	uA
Feedback Resistance	R _f	G version		4.5		KΩ
		H version		3.1		
		J version		3.9		
		K version		3.1		
Internal Capacitor	C _g /C _d	G version, fosc=40MHz		18/18		pF
		H version, fosc=50MHz		16/16		
		J version, fosc=60MHz		11/11		
		K version, fosc=75MHz		10/10		
Maximum Oscillation Frequency	F _{MAX}	G version	40			MHz
		H version	50			
		J version	60			
		K version	75			
Output Signal Symmetry	SYM	C _L =15pF, @V _{DD} /2	45	50	55	%
Output Signal Rise Time	t _r	C _L =15pF, 10% to 90%		3	6	ns
Output Signal Fall Time	t _f	C _L =15pF, 90% to 10%		3	6	ns
Output Disable time	T _{PLZ}	C _L =15pF, R _{UP} =10kΩ			200	ns
Output Enable Time	T _{PZL}	C _L =15pF, R _{UP} =10kΩ			200	ns

Note5) Excluding input current on $\overline{\text{CONT}}$ Terminal.

($V_{DD}=3.0V, T_a=25^{\circ}C$)

PARAMETER	SYMBOL	CONDITIONS	MIN	TYP	MAX	UNIT
Operating Current	I_{DD}	G version, $f_{osc}=40MHz, C_L=15pF$			8	mA
		H version, $f_{osc}=50MHz, C_L=15pF$			10	
		J version, $f_{osc}=60MHz, C_L=15pF$			11	
		K version, $f_{osc}=75MHz, C_L=15pF$			12	
Oscillation Stopping Current	I_{STB}	$\overline{CONT} = V_{SS}$, No load		2	5	uA
Stand-by Current	I_{st}	$\overline{CONT} = XT = V_{SS}$, No load Note5)			1	uA
Input Voltage	V_{IH}		2.1		3.0	V
	V_{IL}		0		0.9	V
Output Current	I_{OH}	$V_{OH}=2.7V$	5			mA
	I_{OL}	$V_{OL}=0.3V$	5			mA
Input Current	I_{IN}	$\overline{CONT} = 0.8V_{DD}$		10.0	15.0	uA
		$\overline{CONT} = 0.2V_{DD}$		1.8	3.0	uA
3-state Off Leakage Current	I_{OZ}	$\overline{CONT} = V_{SS}$, $F_{OUT} = V_{DD}$ or V_{SS}			± 0.1	uA
Feedback Resistance	R_f	G version		4.5		K Ω
		H version		3.1		
		J version		3.9		
		K version		3.1		
Internal Capacitor	C_g/C_d	G version, $f_{osc}=40MHz$		18/18		pF
		H version, $f_{osc}=50MHz$		16/16		
		J version, $f_{osc}=60MHz$		11/11		
		K version, $f_{osc}=75MHz$		10/10		
Maximum Oscillation Frequency	F_{MAX}	G version	40			MHz
		H version	50			
		J version	60			
		K version	75			
Output Signal Symmetry	SYM	$C_L=15pF, @V_{DD}/2$	45	50	55	%
Output Signal Rise Time	t_r	$C_L=15pF, 10\% \sim 90\%$		2.5	5	ns
Output Signal Fall Time	t_f	$C_L=15pF, 90\% \sim 10\%$		2.5	5	ns
Output Disable time	T_{PLZ}	$C_L=15pF, R_{UP}=10k\Omega$			150	ns
Output Enable Time	T_{PZL}	$C_L=15pF, R_{UP}=10k\Omega$			150	ns

Note5) Excluding input current on \overline{CONT} Terminal.

(V_{DD}=5.0V, T_a=25°C)

PARAMETER	SYMBOL	CONDITIONS	MIN	TYP	MAX	UNIT
Operating Current	I _{DD}	G version, fosc=40MHz, C _L =15pF			22	mA
		H version, fosc=50MHz, C _L =15pF			25	
		J version, fosc=60MHz, C _L =15pF			32	
		K version, fosc=75MHz, C _L =15pF			34	
Oscillation Stopping Current	I _{STB}	$\overline{\text{CONT}} = V_{SS}$, No load		5	10	uA
Stand-by Current	I _{st}	$\overline{\text{CONT}} = \text{XT} = V_{SS}$, No load Note5)			1	uA
Input Voltage	V _{IH}		3.5		5.0	V
	V _{IL}		0		1.5	V
Output Current	I _{OH}	V _{OH} =4.5V	8			mA
	I _{OL}	V _{OL} =0.5V	8			mA
Input Current	I _{IN}	$\overline{\text{CONT}} = 0.8V_{DD}$		27.0	40.0	uA
		$\overline{\text{CONT}} = 0.2V_{DD}$		5.5	8.0	uA
3-state Off Leakage Current	I _{OZ}	$\overline{\text{CONT}} = V_{SS}$, F _{OUT} = V _{DD} or V _{SS}			±0.1	uA
Feedback Resistance	R _f	G version		4.5		KΩ
		H version		3.1		
		J version		3.9		
		K version		3.1		
Internal Capacitor	C _g /C _d	G version, fosc=40MHz		18/18		pF
		H version, fosc=50MHz		16/16		
		J version, fosc=60MHz		11/11		
		K version, fosc=75MHz		10/10		
Maximum Oscillation Frequency	F _{MAX}	G version	40			MHz
		H version	50			
		J version	60			
		K version	75			
Output Signal Symmetry	SYM	C _L =15pF, @V _{DD} /2	45	50	55	%
Output Signal Rise Time	t _r	C _L =15pF, 10%~90%		2	4	ns
Output Signal Fall Time	t _f	C _L =15pF, 90%~10%		2	4	ns
Output Disable time	T _{PLZ}	C _L =15pF, R _{UP} =10kΩ			100	ns
Output Enable Time	T _{PZL}	C _L =15pF, R _{UP} =10kΩ			100	ns

Note5) Excluding input current on $\overline{\text{CONT}}$ Terminal.

MEASUREMENT CIRCUITS

(1) Output Signal Symmetry ($C_L=15\text{pF}$)

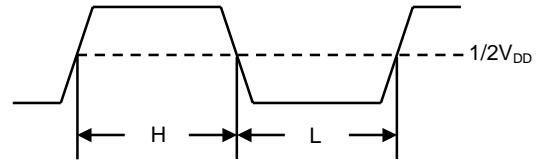
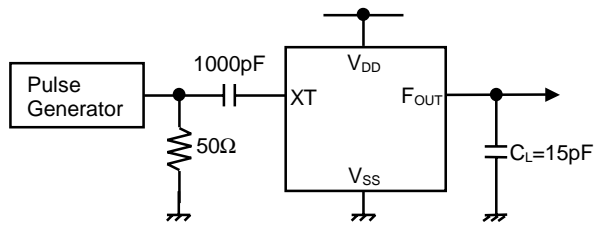

(2) Output Signal Rise/Fall Time ($C_L=15\text{pF}$)

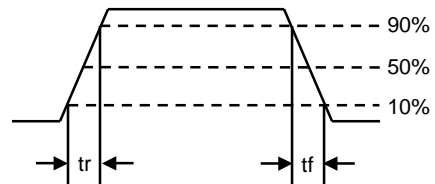
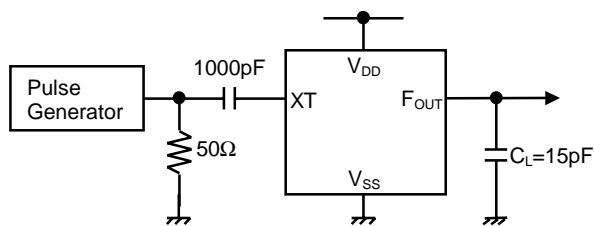

(3) Output Disable/Enable Time ($C_L=15\text{pF}, R_{UP}=10\text{k}\Omega$)

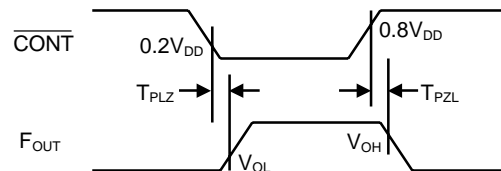
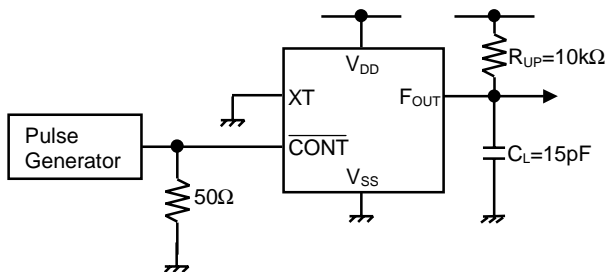

[CAUTION]
 The specifications on this data book are only given for information, without any guarantee as regards either mistakes or omissions. The application circuits in this data book are described only to show representative usages of the product and not intended for the guarantee or permission of any right including the industrial rights.

Mouser Electronics

Authorized Distributor

Click to View Pricing, Inventory, Delivery & Lifecycle Information:

[NJR:](#)

[NJU6376GF1-TE1](#) [NJU6376HF1-TE1](#) [NJU6376JF1-TE1](#) [NJU6376KF1-TE1](#) [NJU6376AF1-TE1](#)