

DATA SHEET

SKY65050-372LF: 0.45-6.0 GHz Low Noise Transistor

Applications

- Wireless infrastructure: WLAN, WiMAX, broadband, cellular base stations
- Test instrumentation
- LNA for GPS receivers
- Satellite receivers

Features

- Externally matched for wideband operation
- Noise Figure = 0.45 dB @ 2.4 GHz of device only
- Noise Figure = 0.65 dB @ 2.4 GHz including matching network loss
- Gain = 15.5 dB @ 2.4 GHz
- OIP3 = +23.5 dBm @ 2.4 GHz, $V_{DD} = 3\text{ V}$, $I_{DD} = 20\text{ mA}$
- P1dB = +10.5 dBm @ 2.4 GHz, $V_{DD} = 3\text{ V}$, $I_{DD} = 20\text{ mA}$
- Adjustable supply current, 5 to 55 mA
- Small, SC-70 (4-pin, 2.20 x 1.35 x 1.10 mm) package (MSL1, 260 °C per JEDEC J-STD-020)



Skyworks Green™ products are compliant with all applicable legislation and are halogen-free. For additional information, refer to *Skyworks Definition of Green™*, document number SQ04-0074.

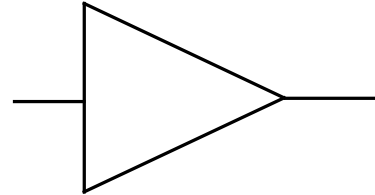

Figure 1. SKY65050-372LF Block Diagram

Description

The SKY65050-372LF is a high performance, n-channel low-noise transistor. The device is fabricated from Skyworks advanced depletion mode pHEMT process and is provided in a 2.20 x 1.35 x 1.10 mm, 4-pin SC-70 package.

The transistor's low Noise Figure (NF), high gain, and excellent 3rd Order Intercept Point (IP3) allow the device to be used in various receiver and transmitter applications.

A functional block diagram is shown in Figure 1. The pin configuration and package are shown in Figure 2. Signal pin assignments and functional pin descriptions are provided in Table 1.

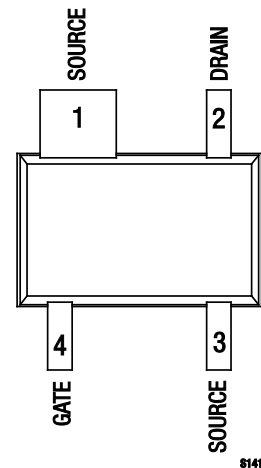

Figure 2. SKY65050-372LF Pinout – 4-Pin SC-70 (Top View)

Table 1. SKY65050-372LF Signal Descriptions

Pin #	Name	Description	Pin #	Name	Description
1	SOURCE	Source lead. Provides DC self-biasing point and AC ground.	3	SOURCE	Source lead. Provides DC self-biasing point and AC ground.
2	DRAIN	RF output. Requires external matching network for optimum performance. Supply voltage required through external RF choke.	4	GATE	RF input. Requires external matching network for optimum performance.

Table 2. Self-Biasing Resistors

Resistor Value (Ω)	Drain Current (mA)
130	5
47	10
27	15
20	20
15	25
10	30

Functional Description

The SKY65050-372LF is a depletion mode pHEMT designed for low noise, high frequency applications. The SKY65050-372LF has a typical NF of 0.65 dB tested at the 2.4 GHz wireless LAN frequency band. A gain of 15.5 dB typical is achieved using the same circuit. If the frequency of operation is lowered to the 1 GHz range, NF performance of the device can approach 0.5 dB including input matching network losses.

De-embedded scattering and noise parameters are provided in addition to typical circuit topologies for commonly used frequency bands. With an appropriate circuit, the SKY65050-372LF can be used for many applications from 450 MHz up to 6 GHz. The compact SC-70 package makes the SKY65050-372LF an ideal low noise and low cost solution.

Biasing

To properly bias a depletion mode pHEMT, both the gate and drain of the device must be properly biased. At $V_{GS} = 0\text{ V}$ and $V_{DS} \geq 2\text{ V}$, the device is in a saturated state and draws the maximum amount of current, I_{DSS} . The device typically achieves the best noise performance at $V_{DS} = 3\text{ V}$ and $I_{DSS} = 15\text{ mA}$. To control I_{DS} , V_{GS} must be biased with a negative voltage supply.

To eliminate the need for a negative DC supply, self-biasing should be used when a resistor is placed between one of the source leads and ground. A bypass capacitor should be placed in parallel to this resistor to provide an RF ground and to ensure performance remains unchanged at the operating frequency.

When current flows from drain to source and through the resistor, the source voltage becomes biased above DC ground. The gate pin of the device should be left unbiased at 0 V, which creates the

desired negative V_{GS} value. This simplifies the design by eliminating the need for a second DC supply.

Table 2 provides the resistor values used to properly bias the SKY65050-372LF.

RF Matching Networks

The SKY65050-372LF Evaluation Board assembly diagram is shown in Figure 12 and a circuit schematic is provided in Figure 13. The schematic shows the recommended RF matching network used for the 2.4 GHz wireless LAN frequency band. The network was designed using de-embedded s- and n-parameters. The circuit was primarily tuned for gain, NF, and input and output return loss, while maintaining proper stability.

Optimal noise performance is attained when the impedance presented to the input of the amplifier is equal to its minimum NF impedance point. Components C1, C2, C3, L1, and L2 shown in Figures 12 and 13 provide the necessary impedance match for NF and input return loss. Circuit board and input matching structure losses on the input of the amplifier directly add to the overall NF of the amplifier. It is critical to minimize RF trace lengths and to use high-Q components to achieve optimal NF performance.

Components R2 and C14 provide self biasing for the device and RF grounding for one of the two source leads. Components C5 and L3 are placed on the opposing source lead and are used to tune the transistor’s source inductance.

The effect of source inductance varies with frequency. Too little source inductance increases gain and high frequency stability, but at the cost of decreased in-band stability. Too much source inductance decreases high frequency stability and gain, but increases in-band stability. It is very important to find the optimum tuning of source inductance that balances all of these variables.

The output matching topology is typical for an RF transistor. Component L3 is the RF choke that prevents RF signals from reaching the DC supply. Component C4 is the DC blocking capacitor. Components C10 and C11 improve output return loss and 3rd Order Output Intercept Point (OIP3) performance.

Electrical and Mechanical Specifications

The absolute maximum ratings of the SKY65050-372LF are provided in Table 3. The recommended operating conditions are specified in Table 4 and electrical specifications are provided in Table 5.

Performance characteristics for the SKY65050-372LF are illustrated in Figures 3 through 11.

Table 3. SKY65050-372LF Absolute Maximum Ratings

Parameter	Symbol	Minimum	Typical	Maximum	Units
Input power	P _{IN}			+10	dBm
Output power	P _{OUT}			+20	dBm
Drain source voltage	V _{DS}		6.0		V
Gate to source voltage	V _{GS}		-5.0		V
Gate to drain voltage	V _{GD}		-5.0		V
Drain current	I _{DS}		55		mA
Gate current	I _{GS}		100		μA
Power dissipation	P _{DIS}		240		mW
Channel temperature	T _{CHAN}		150		°C
Storage temperature	T _{STG}	-65		+125	°C
Operating temperature	T _{OP}	-40		+85	°C

Note: Exposure to maximum rating conditions for extended periods may reduce device reliability. There is no damage to device with only one parameter set at the limit and all other parameters set at or below their nominal value. Exceeding any of the limits listed here may result in permanent damage to the device.



Attention: Observe Precautions for Handling Electrostatic Sensitive Devices

ESD Man-Machine (MM) Model = <50 V (Class A)

ESD Human Body Model (HBM) = 150 V (Class 0)

ESD Charge Device Model (CDM) = 500 V (Class 3)

Electrostatic Discharge (ESD) can damage this device, which must be protected from ESD at all times. Static charges may easily produce potentials of several kilovolts on the human body or equipment, which can discharge without detection. Industry-standard ESD precautions should be used at all times.

Table 4. SKY65050-372LF Recommended Operating Conditions

Parameter	Symbol	Minimum	Typical	Maximum	Units
Supply voltage	V _{DD}	2	3	5	V
Supply current	I _{DD}	5	20	55	mA

Table 5. SKY65050-372LF Electrical Specifications (Note 1)

($T_{OP} = +25\text{ }^{\circ}\text{C}$, Characteristic Impedance [Z_0] = $50\ \Omega$, $V_{DD} = 3\text{ V}$, $I_{DD} = 20\text{ mA}$, Parameters Include a 2.4 GHz Matching Network, Unless Otherwise Noted)

Parameter	Symbol	Test Condition	Min	Typical	Max	Units
Saturated drain current	I_{DSS}	$V_{DS} = 2\text{ V}$, $V_{GS} = 0\text{ V}$	40	55	70	mA
Pinchoff voltage	V_P	$V_{DS} = 2\text{ V}$, $I_{DS} = 2.5\%$ of I_{DSS}	-0.95	-0.80	-0.65	V
Transconductance	g_M	$V_{DS} = 2\text{ V}$, $g_M = \Delta I_{DS} / \Delta V_{GS}$, measured at $I_{DS} = 20\%$ of I_{DSS}	40	80	120	mS
Gate leakage current	I_{GSS}	$V_{GD} = V_{GS} = -3\text{ V}$		1	200	μA
Noise Figure	NF1 (Note 2) NF2 (Note 3)	@ 2.4 GHz		0.40 0.65	0.85	dB dB
Gain	$ S_{21} $	@ 2.4 GHz	13.5	15.5	17.5	dB
Input return loss	$ S_{11} $	@ 2.4 GHz		18.5		dB
Output return loss	$ S_{22} $	@ 2.4 GHz		14		dB
Reverse isolation	$ S_{12} $	@ 2.4 GHz		22.5		dB
3 rd Order Output Intercept Point	OIP3	$P_{OUT} = -10\text{ dBm/ tone}$, $\Delta F = 1\text{ MHz}$, @ 2.4 GHz		+23.5		dBm
3 rd Order Input Intercept Point	IIP3	$P_{OUT} = -10\text{ dBm/ tone}$, $\Delta F = 1\text{ MHz}$, @ 2.4 GHz		+8		dBm
1 dB Output Compression Point	OP1dB	@ 2.4 GHz		+10.5		dBm
1 dB Input Compression Point	IP1dB	@ 2.4 GHz		-4		dBm
Stability	K	Unconditionally stable, DC – 18 GHz		>1		-

Note 1: Performance is guaranteed only under the conditions listed in this Table and is not guaranteed over the full operating or storage temperature ranges. Operation at elevated temperatures may reduce reliability of the device.

Note 2: NF of device only. Input RF connector, board, and input matching network loss de-embedded from measurement.

Note 3: NF of device and matching network. Input RF connector and board loss de-embedded from measurement.

Typical Performance Characteristics

($T_{OP} = +25\text{ }^{\circ}\text{C}$, Characteristic Impedance [Z_0] = $50\ \Omega$, $V_{DD} = 3\text{ V}$, $I_{DD} = 20\text{ mA}$, Includes a 2.4 GHz Matching Network, Unless Otherwise Noted)

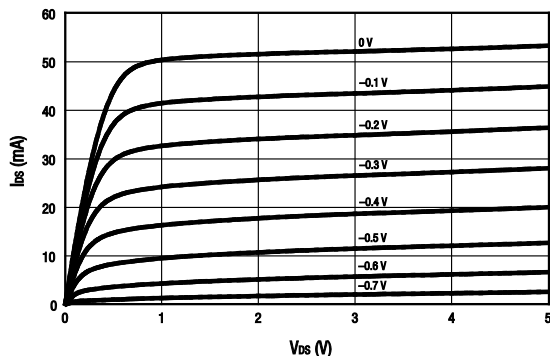

Figure 3. Typical IV Curves

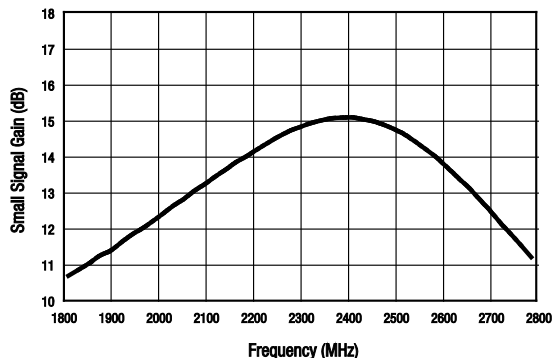

Figure 4. Small Signal Gain vs Frequency, $P_{IN} = -20\text{ dBm}$

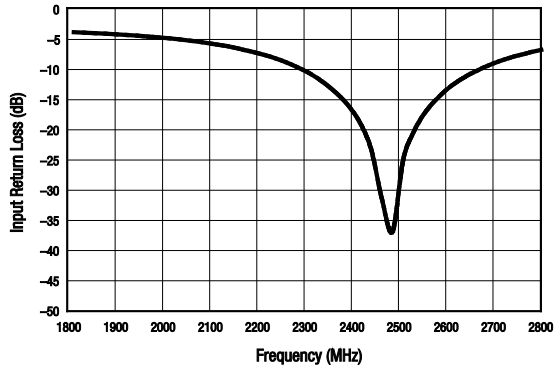

Figure 5. Input Return Loss vs Frequency, $P_{IN} = -20$ dBm

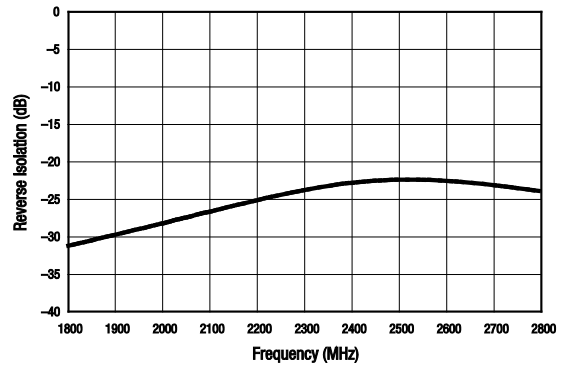

Figure 6. Reverse Isolation vs Frequency, $P_{IN} = -20$ dBm

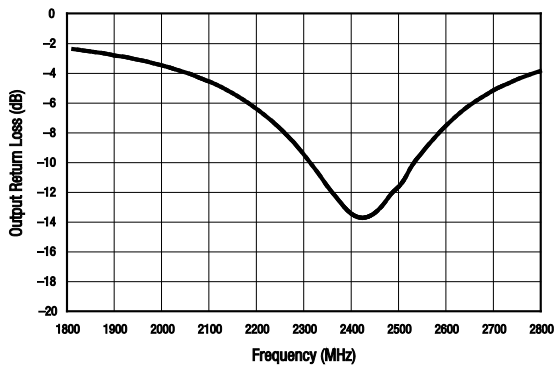

Figure 7. Output Return Loss vs Frequency, $P_{IN} = -20$ dBm

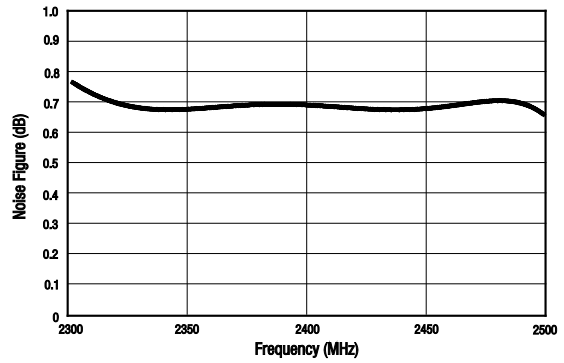

Figure 8. NF vs Frequency, Input RF Connector and Board Loss De-Embedded From Measurement

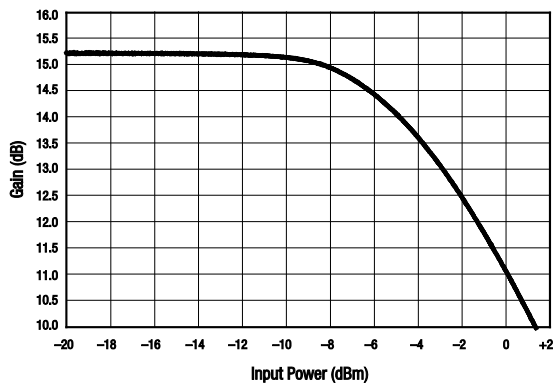

Figure 9. Gain vs Input Power, $F = 2.4$ GHz

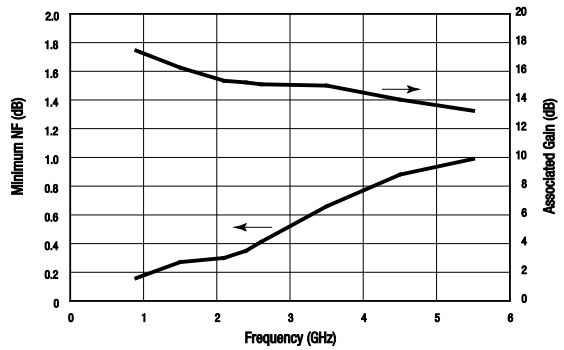

Figure 10. Minimum NF and Associated Gain vs Frequency, $I_{DD} = 15$ mA

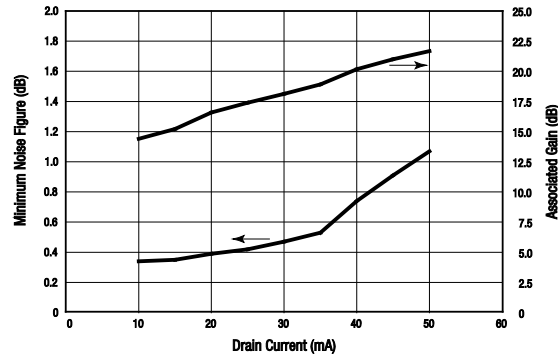

Figure 11. Minimum NF and Associated Gain vs Drain Current, F = 2.4 GHz

Evaluation Board Description

The SKY65050-372LF Evaluation Board is used to test the performance of the SKY65050-372LF low noise transistor. An assembly drawing for the Evaluation Board is shown in Figure 12. The Evaluation Board schematic diagram is shown in Figure 13. Table 6 provides the Bill of Materials (BOM) list for Evaluation Board components.

The board is populated for 2.4 GHz operation and contains a separate probe footprint for general device testing or source and load pull characterization. The board is provisioned with two RF connectors and a 3-pin DC launch. The RF connector and board loss up to component C1 is approximately 0.15 dB at 2.4 GHz.

Board material is 10 mil thick VT47 FR4 with 1 oz. copper cladding. RF input and output traces are 50 Ω.

Evaluation Board Test Procedure

- Step 1: Connect RF test equipment to amplifier input/output SMA connectors.
- Step 2: Connect DC ground.
- Step 3: Connect VDD to a +3 V supply with a current limit of 60 mA. Verify that the board draws approximately 20 mA.
- Step 4: Apply RF signal or noise source and verify performance detailed in Table 5.

Package Dimensions

The PCB layout footprint for the SKY65050-372LF is shown in Figure 14. Typical case markings are shown in Figure 15. Package dimensions for the 4-pin SC-70 are shown in Figure 16, and tape and reel dimensions are provided in Figure 17.

Package and Handling Information

Since the device package is sensitive to moisture absorption, it is baked and vacuum packed before shipping. Instructions on the shipping container label regarding exposure to moisture after the container seal is broken must be followed. Otherwise, problems related to moisture absorption may occur when the part is subjected to high temperature during solder assembly.

THE SKY65050-372LF is rated to Moisture Sensitivity Level 1 (MSL1) at 260 °C. It can be used for lead or lead-free soldering.

Care must be taken when attaching this product, whether it is done manually or in a production solder reflow environment. Production quantities of this product are shipped in a standard tape and reel format. For packaging details, refer to the Skyworks Application Note, *Discrete Devices and IC Switch/Attenuators Tape and Reel Package Orientation*, document number 200083.

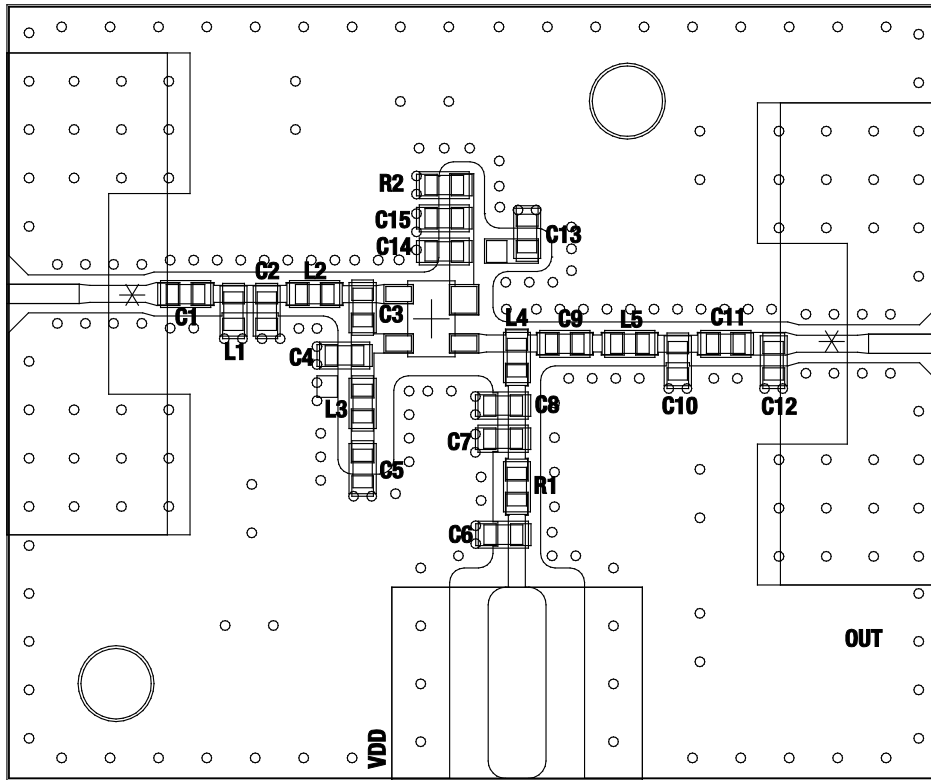

S1410

Figure 12. SKY65050-372LF Evaluation Board Assembly Diagram

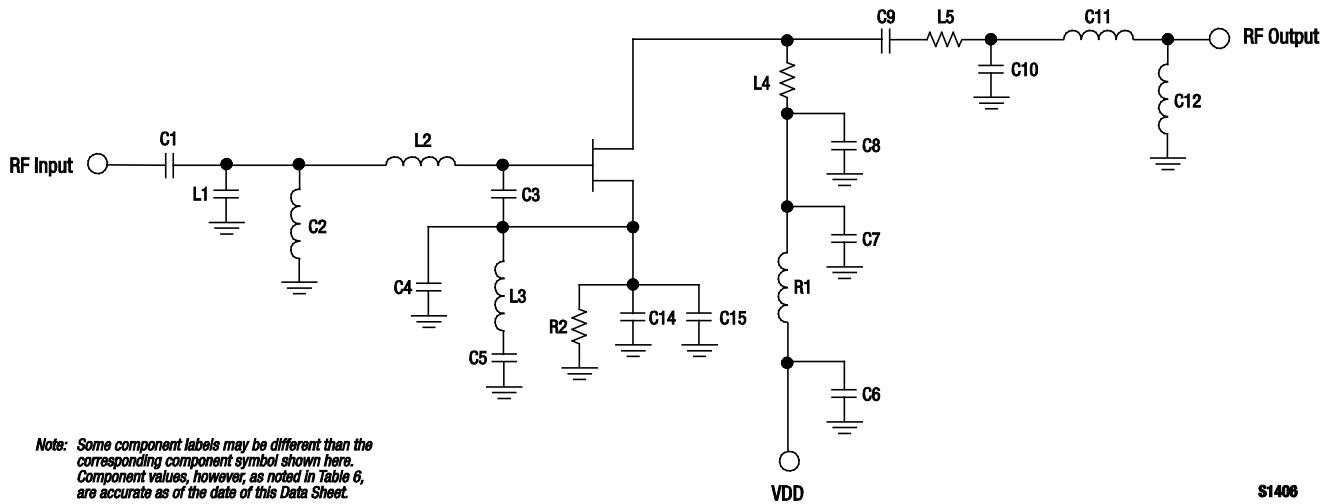

S1406

Figure 13. SKY65050-372LF Evaluation Board Schematic

Table 6. SKY65050-372LF (SC-70 Package) Evaluation Board Bill of Materials

Component	Value	Size	Manufacturer/Part Series
C1	20 pF	0402	Murata GJM
C2	8.2 nH	0402	Coilcraft CS
C3	0.1 pF	0402	Murata GJM
C4, C7, C8, C13	DNP		
C5	1000 pF	0402	Murata GRM
C6	10 pF	0402	Murata GRM
C9	1.8 pF	0402	Murata GRM
C10	0.2 pF	0402	Murata GJM
C11	3.3 nH	0402	TDK MLG
C12	6.8 nH	0402	TDK MLG
C14	1000 pF	0402	Murata GRM
C15	1000 pF	0402	Murata GRM
L1	1.5 pF	0402	Murata GJM
L2	3.3 nH	0402	Coilcraft CS
L3	1.6 nH	0402	TDK MLG
L4	3 Ω	0402	Panasonic
L5	0 Ω	0402	Panasonic
R1	2.2 nH	0402	TDK MLG
R2	20 Ω	0402	Panasonic

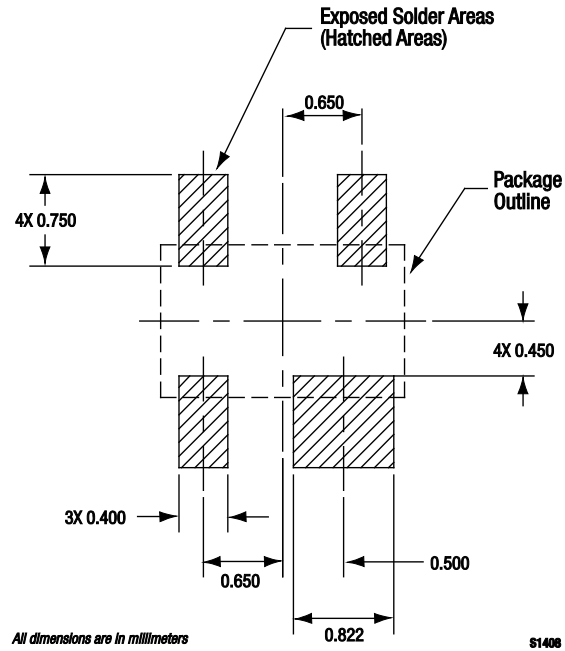

Figure 14. SKY65050-372LF PCB Layout Footprint

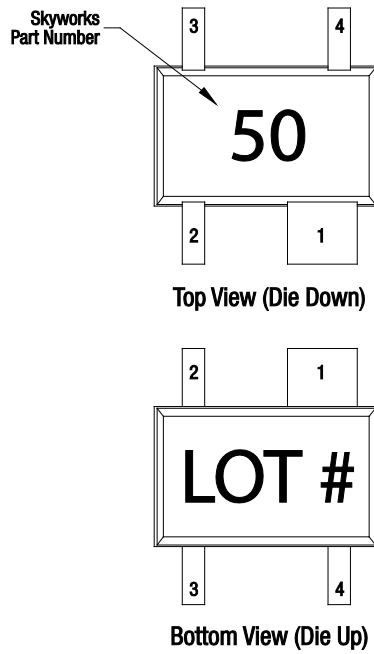
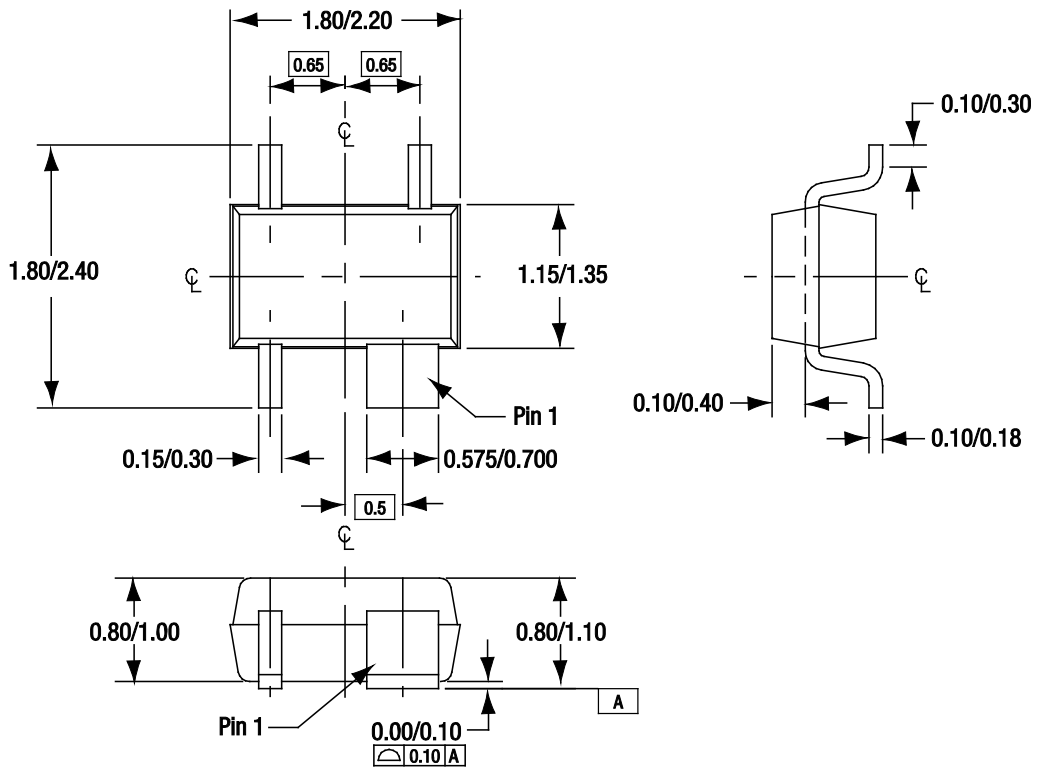

Figure 15. Typical Part Markings



Dimensioning and tolerancing according to ASME Y14.5M-1994.
All measurements are in millimeters

S1409

Figure 16. SKY65050-372LF 4-Pin SC-70 Package Dimensions

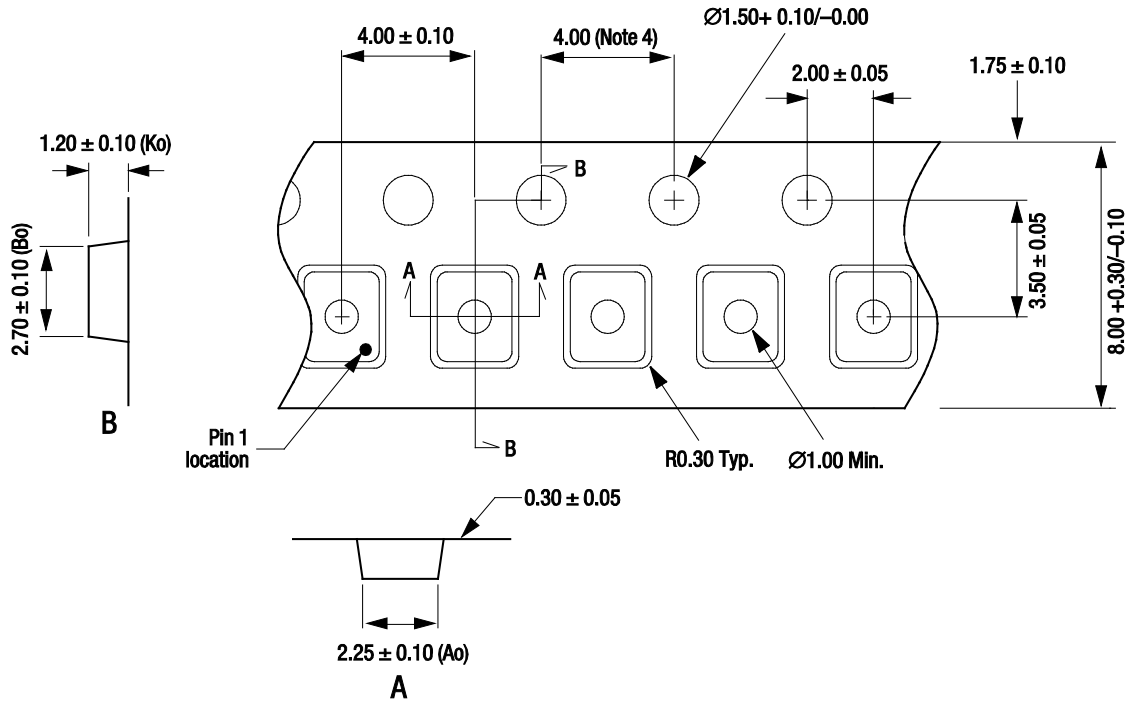

- Notes:**
1. Carrier tape: black conductive polystyrene.
 2. Cover tape material: transparent conductive HSA.
 3. Cover tape size: 5.40 mm width.
 4. Ten sprocket hole pitch cumulative tolerance ± 0.20 mm.
 5. All measurements are in millimeters.

S1620

Figure 17. SKY65050-372LF Tape and Reel Dimensions

Ordering Information

Model Name	Manufacturing Part Number	Evaluation Board Part Number
SKY65050-372LF Low Noise Transistor	SKY65050-372LF	SKY65050-372LF (2400 MHz)

Copyright © 2008, 2009, 2012 Skyworks Solutions, Inc. All Rights Reserved.

Information in this document is provided in connection with Skyworks Solutions, Inc. ("Skyworks") products or services. These materials, including the information contained herein, are provided by Skyworks as a service to its customers and may be used for informational purposes only by the customer. Skyworks assumes no responsibility for errors or omissions in these materials or the information contained herein. Skyworks may change its documentation, products, services, specifications or product descriptions at any time, without notice. Skyworks makes no commitment to update the materials or information and shall have no responsibility whatsoever for conflicts, incompatibilities, or other difficulties arising from any future changes.

No license, whether express, implied, by estoppel or otherwise, is granted to any intellectual property rights by this document. Skyworks assumes no liability for any materials, products or information provided hereunder, including the sale, distribution, reproduction or use of Skyworks products, information or materials, except as may be provided in Skyworks Terms and Conditions of Sale.

THE MATERIALS, PRODUCTS AND INFORMATION ARE PROVIDED "AS IS" WITHOUT WARRANTY OF ANY KIND, WHETHER EXPRESS, IMPLIED, STATUTORY, OR OTHERWISE, INCLUDING FITNESS FOR A PARTICULAR PURPOSE OR USE, MERCHANTABILITY, PERFORMANCE, QUALITY OR NON-INFRINGEMENT OF ANY INTELLECTUAL PROPERTY RIGHT; ALL SUCH WARRANTIES ARE HEREBY EXPRESSLY DISCLAIMED. SKYWORKS DOES NOT WARRANT THE ACCURACY OR COMPLETENESS OF THE INFORMATION, TEXT, GRAPHICS OR OTHER ITEMS CONTAINED WITHIN THESE MATERIALS. SKYWORKS SHALL NOT BE LIABLE FOR ANY DAMAGES, INCLUDING BUT NOT LIMITED TO ANY SPECIAL, INDIRECT, INCIDENTAL, STATUTORY, OR CONSEQUENTIAL DAMAGES, INCLUDING WITHOUT LIMITATION, LOST REVENUES OR LOST PROFITS THAT MAY RESULT FROM THE USE OF THE MATERIALS OR INFORMATION, WHETHER OR NOT THE RECIPIENT OF MATERIALS HAS BEEN ADVISED OF THE POSSIBILITY OF SUCH DAMAGE.

Skyworks products are not intended for use in medical, lifesaving or life-sustaining applications, or other equipment in which the failure of the Skyworks products could lead to personal injury, death, physical or environmental damage. Skyworks customers using or selling Skyworks products for use in such applications do so at their own risk and agree to fully indemnify Skyworks for any damages resulting from such improper use or sale.

Customers are responsible for their products and applications using Skyworks products, which may deviate from published specifications as a result of design defects, errors, or operation of products outside of published parameters or design specifications. Customers should include design and operating safeguards to minimize these and other risks. Skyworks assumes no liability for applications assistance, customer product design, or damage to any equipment resulting from the use of Skyworks products outside of stated published specifications or parameters.

Skyworks, the Skyworks symbol, and "Breakthrough Simplicity" are trademarks or registered trademarks of Skyworks Solutions, Inc., in the United States and other countries. Third-party brands and names are for identification purposes only, and are the property of their respective owners. Additional information, including relevant terms and conditions, posted at www.skyworksinc.com, are incorporated by reference.

Mouser Electronics

Authorized Distributor

Click to View Pricing, Inventory, Delivery & Lifecycle Information:

[Skyworks:](#)

[SKY65050-372LF](#) [SKY65050-372LF-EVB](#)