

Turbo 2 ultrafast high voltage rectifier

Datasheet - production data

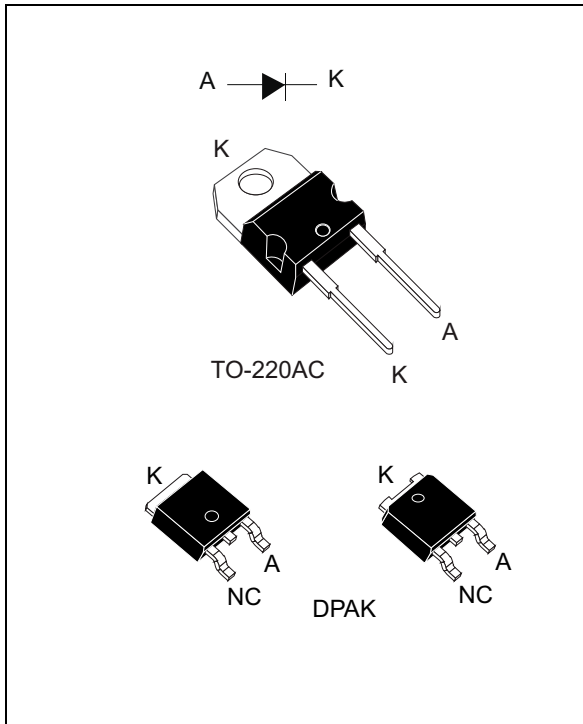

Description

The STTH506 is developed using ST's Turbo 2 600 V technology. It is well-suited for use in switching power supplies and industrial applications.

Table 1. Device summary

Symbol	Value
$I_{F(AV)}$	5 A
V_{RRM}	600 V
$t_{rr} (max)$	30 ns
$T_j (max)$	175 °C
$V_F (typ)$	1.1 V

Features

- Ultrafast switching
- Low reverse current
- Low thermal resistance
- Reduces conduction and switching losses
- ECOPACK[®]2 compliant component for DPAK on demand

1 Characteristics

Table 2. Absolute ratings (limiting values at 25° C, unless otherwise specified)

Symbol	Parameter		Value	Unit	
V_{RRM}	Repetitive peak reverse voltage		600	V	
$I_{F(RMS)}$	RMS forward current	TO-220AC	20	A	
		DPAK	10	A	
$I_{F(AV)}$	Average forward current, $\delta = 0.5$, square wave.	$T_C = 145^\circ\text{C}$	TO-220AC DPAK	5	A
I_{FSM}	Surge non repetitive forward current	$t_p = 10\text{ ms}$ Sinusoidal	TO-220AC	70	A
			DPAK	55	A
T_{stg}	Storage temperature range		-65 to +175	°C	
T_j	Maximum operating junction temperature		175	°C	

Table 3. Thermal parameters

Symbol	Parameter	Max. value	Unit
$R_{th(j-c)}$	Junction to case	3.5	°C/W

Table 4. Static electrical characteristics

Symbol	Parameter	Test conditions		Min.	Typ	Max.	Unit
$I_R^{(1)}$	Reverse leakage current	$T_j = 25^\circ\text{C}$	$V_R = V_{RRM}$	-		5	μA
		$T_j = 150^\circ\text{C}$		-	13	130	
$V_F^{(2)}$	Forward voltage drop	$T_j = 25^\circ\text{C}$	$I_F = 5\text{ A}$	-		1.85	V
		$T_j = 150^\circ\text{C}$		-	1.10	1.40	

1. Pulse test: $t_p = 5\text{ ms}$, $\delta < 2\%$

2. Pulse test: $t_p = 380\text{ }\mu\text{s}$, $\delta < 2\%$

To evaluate the conduction losses, use the following equation:

$$P = 1.07 \times I_{F(AV)} + 0.066 \times I_{F(RMS)}^2$$

Table 5. Dynamic characteristics

Symbol	Parameter	Test conditions		Min.	Typ	Max.	Unit
t_{rr}	Reverse recovery time	$T_j = 25^\circ \text{C}$	$I_F = 0.5 \text{ A}$ $I_{rr} = 0.25 \text{ A}$ $I_R = 1 \text{ A}$	-		30	ns
			$I_F = 1 \text{ A}$ $V_R = 30 \text{ V}$ $di_F/dt = -50 \text{ A}/\mu\text{s}$	-	35	50	
I_{RM}	Reverse recovery current	$T_j = 125^\circ \text{C}$	$I_F = 5 \text{ A}$ $V_R = 400 \text{ V}$ $di_F/dt = -100 \text{ A}/\mu\text{s}$	-	3.5	5	A
Q_{rr}	Reverse recovery charges			-	175		nC
t_{fr}	Forward recovery time	$T_j = 25^\circ \text{C}$	$I_F = 5 \text{ A}$ $V_{FR} = 1.1 \times V_{Fmax}$ $di_F/dt = 100 \text{ A}/\mu\text{s}$	-		180	ns
V_{FP}	Forward recovery voltage			-	4		V

Figure 1. Conduction losses versus average current

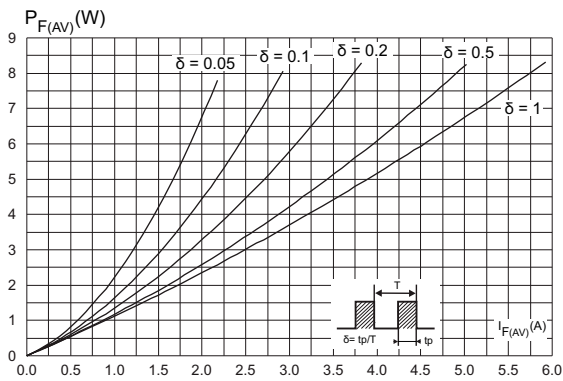

Figure 2. Forward voltage drop versus forward current

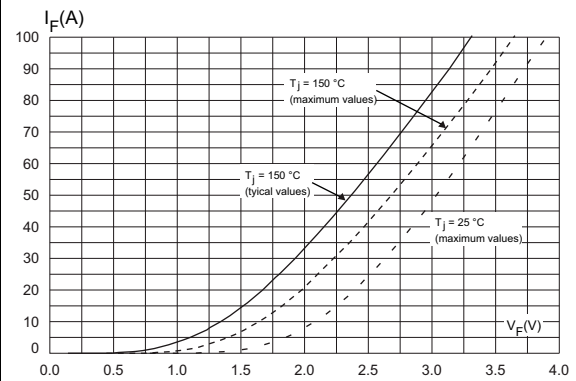

Figure 3. Relative variation of thermal impedance junction to case versus pulse duration

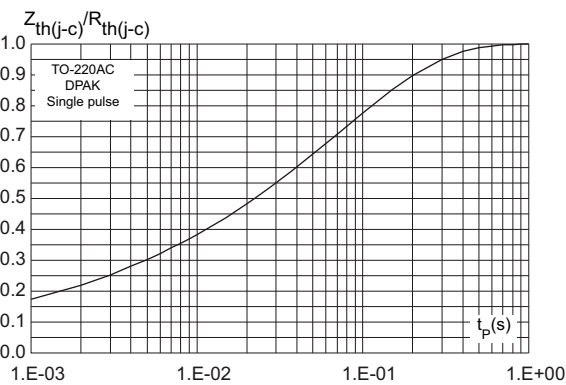

Figure 4. Peak reverse recovery current versus di_F/dt (typical values)

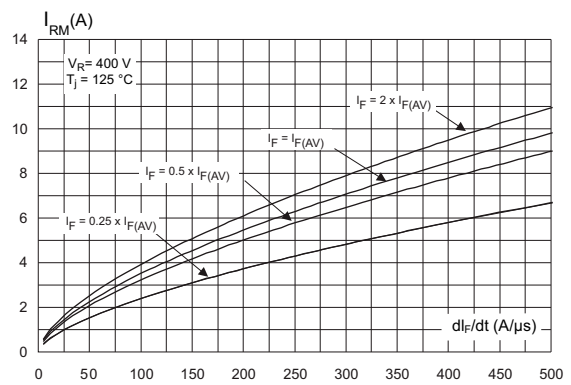

Figure 5. Reverse recovery time versus di_F/dt (typical values)

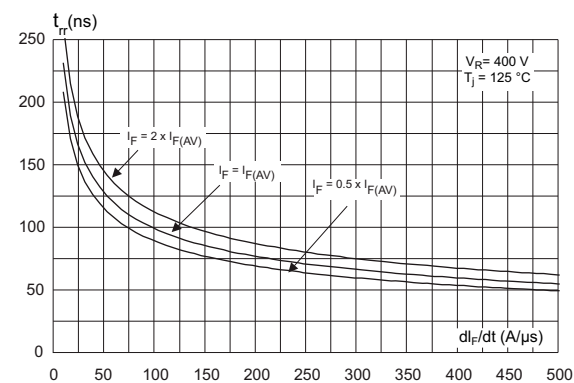

Figure 6. Reverse recovery charges versus di_F/dt (typical values)

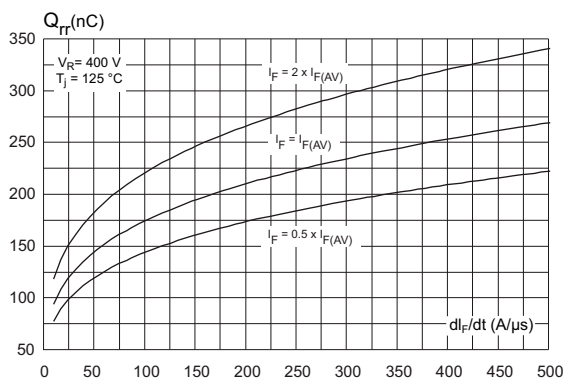

Figure 7. Softness factor versus di_F/dt (typical values)

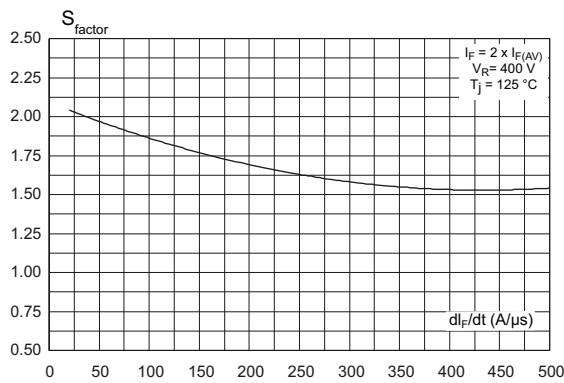

Figure 8. Relative variations of dynamic parameters versus junction temperature

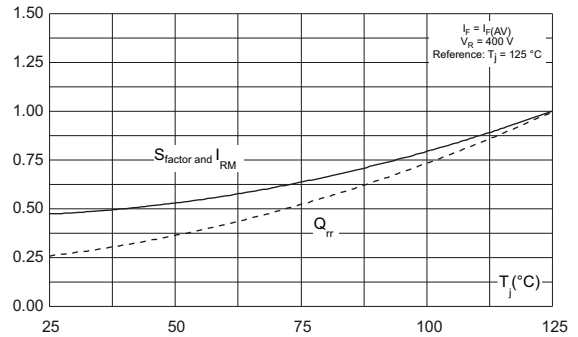

Figure 9. Transient peak forward voltage versus di_F/dt (typical values)

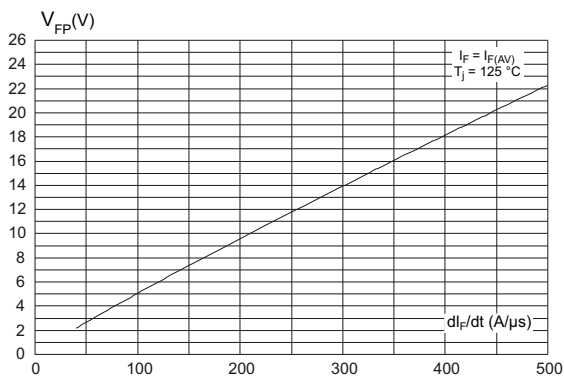

Figure 10. Forward recovery time versus di_F/dt (typical values)

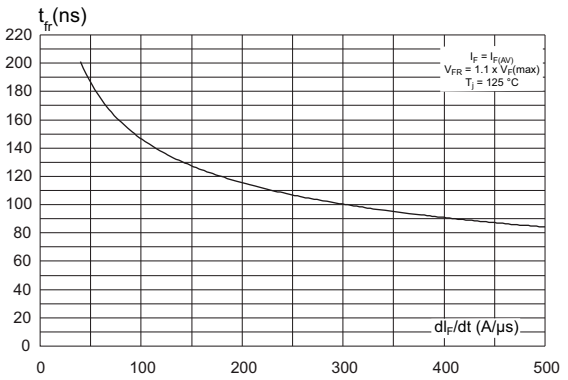

Figure 11. Junction capacitance versus reverse voltage applied (typical values)

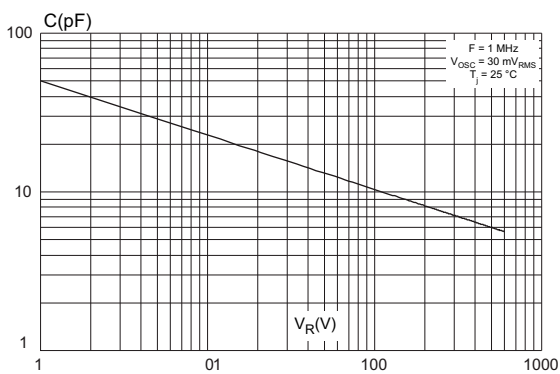
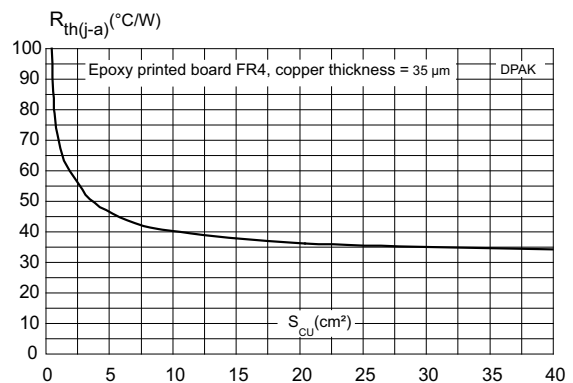

Figure 12. Thermal resistance junction to ambient versus copper surface under tab



2 Package Information

- Epoxy meets UL94, V0
- Cooling method: by conduction (C)
- Recommended torque value: 0.55 Nm for TO-220AC
- Maximum torque value: 0.7 Nm for TO-220AC

In order to meet environmental requirements, ST offers these devices in different grades of ECOPACK® packages, depending on their level of environmental compliance. ECOPACK® specifications, grade definitions and product status are available at: www.st.com. ECOPACK® is an ST trademark.

2.1 DPAK package information

Figure 13. DPAK package outline

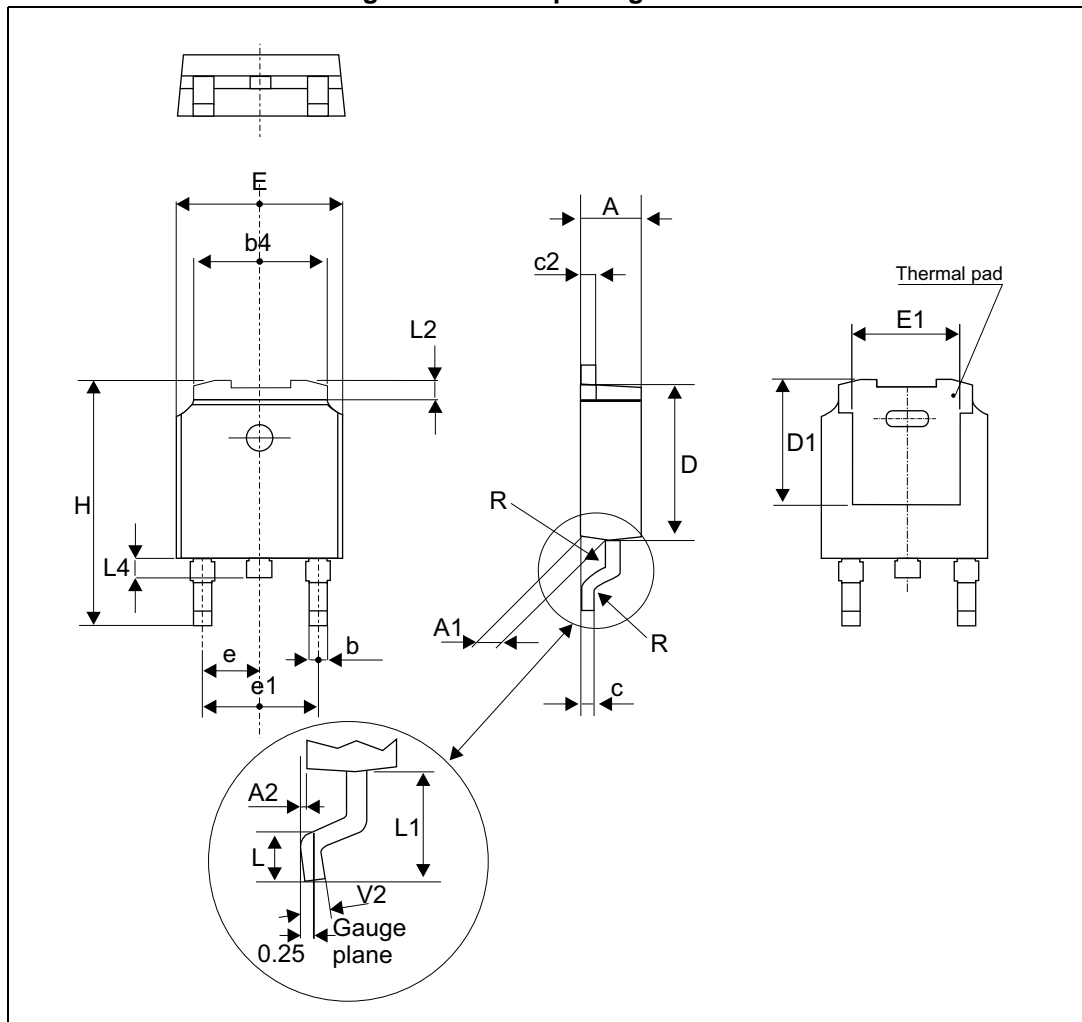

Note: This package drawing may slightly differ from the physical package. However, all the specified dimensions are guaranteed.

Table 6. DPAK package mechanical data

Ref.	Dimensions					
	Millimeters			Inches		
	Min.	Typ.	Max.	Min.	Typ.	Max.
A	2.18		2.40	0.085		0.094
A1	0.90		1.10	0.035		0.043
A2	0.03		0.23	0.001		0.009
b	0.64		0.90	0.025		0.035
b4	4.95		5.46	0.194		0.214
c	0.46		0.61	0.018		0.024
c2	0.46		0.60	0.018		0.023
D	5.97		6.22	0.235		0.244
D1	4.95		5.60	0.194		0.220
E	6.35		6.73	0.250		0.264
E1	4.32		5.50	0.170		0.216
e		2.28			0.090	
e1	4.40		4.70	0.173		0.185
H	9.35		10.40	0.368		0.409
L	1.00		1.78	0.039		0.070
L2			1.27			0.050
L4	0.60		1.02	0.023		0.040
V2	-8°		+8°	-8°		8°

Figure 14. Footprint (dimensions in mm)

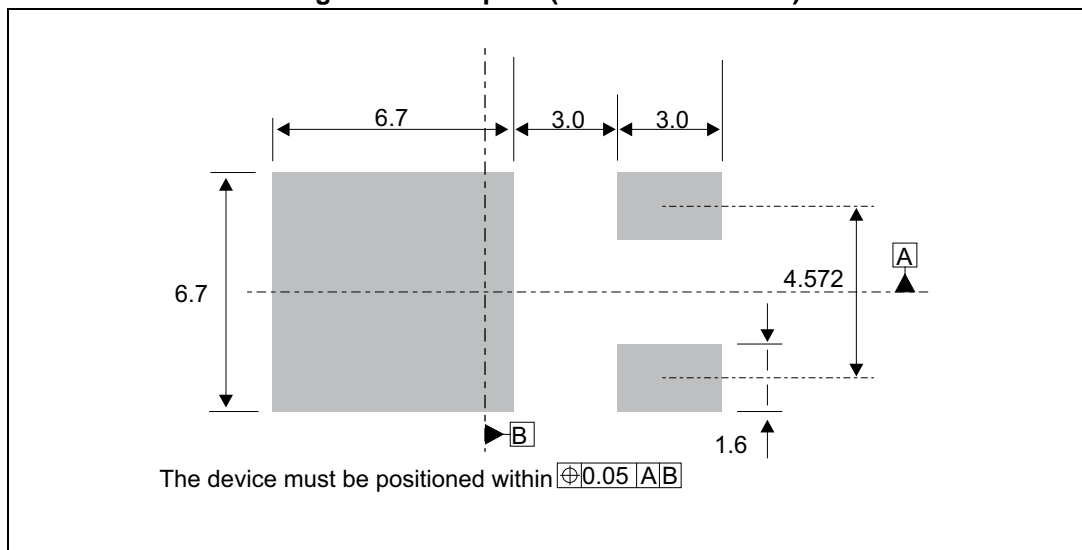

2.2 TO-220AC package information

Figure 15. TO-220AC package outline

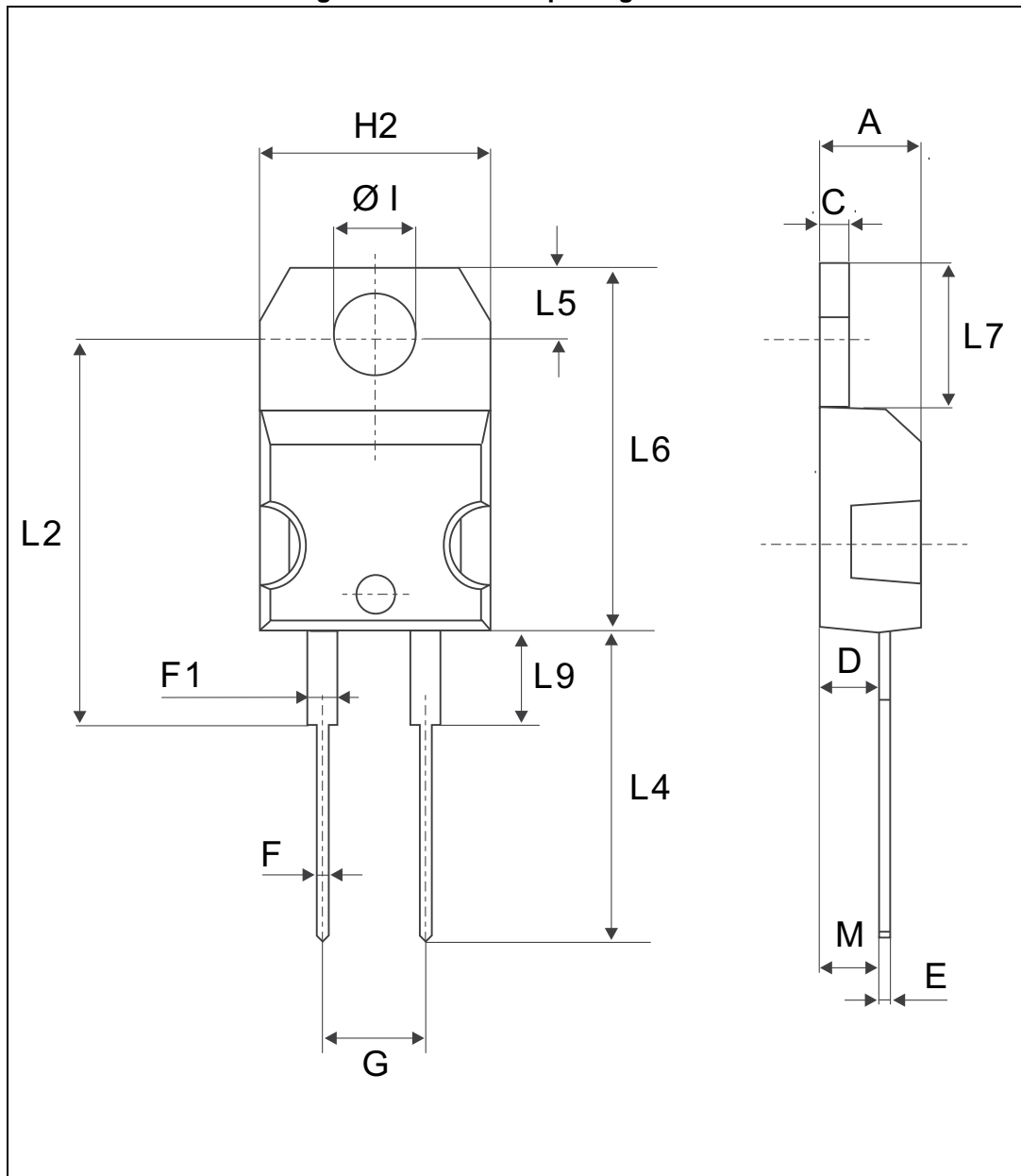

Table 7. TO-220AC package mechanical data

Ref.	Dimensions					
	Millimeters			Inches		
	Min.	Typ.	Max.	Min.	Typ.	Max.
A	4.40		4.60	0.173		0.181
C	1.23		1.32	0.048		0.051
D	2.40		2.72	0.094		0.107
E	0.49		0.70	0.019		0.027
F	0.61		0.88	0.024		0.034
F1	1.14		1.70	0.044		0.066
G	4.95		5.15	0.194		0.202
H2	10.00		10.40	0.393		0.409
L2		16.40 typ.			0.645 typ.	
L4	13.00		14.00	0.511		0.551
L5	2.65		2.95	0.104		0.116
L6	15.25		15.75	0.600		0.620
L7	6.20		6.60	0.244		0.259
L9	3.50		3.93	0.137		0.154
M		2.6 typ.			0.102 typ.	
Diam. I	3.75		3.85	0.147		0.151

3 Ordering Information

Table 8. Ordering information

Order code	Marking	Package	Weight	Base qty	Delivery mode
STTH506B-TR	STTH 506B	DPAK	0.30 g	2500	Tape and reel
STTH506B	STTH 506B	DPAK	0.30 g	75	Tube
STTH506D	STTH506D	TO-220AC	1.86 g	50	Tube

4 Revision history

Table 9. Document revision history

Date	Revision	Description of Changes
14-Oct-2008	1	First issue.
08-Aug-2014	2	Updated DPAK package information and removed TO-220AB package.
26-Nov-2014	3	Updated Figure 13 and Figure 14.
03-Nov-2016	4	Updated DPAK package information and reformatted to current standard.

IMPORTANT NOTICE – PLEASE READ CAREFULLY

STMicroelectronics NV and its subsidiaries ("ST") reserve the right to make changes, corrections, enhancements, modifications, and improvements to ST products and/or to this document at any time without notice. Purchasers should obtain the latest relevant information on ST products before placing orders. ST products are sold pursuant to ST's terms and conditions of sale in place at the time of order acknowledgement.

Purchasers are solely responsible for the choice, selection, and use of ST products and ST assumes no liability for application assistance or the design of Purchasers' products.

No license, express or implied, to any intellectual property right is granted by ST herein.

Resale of ST products with provisions different from the information set forth herein shall void any warranty granted by ST for such product.

ST and the ST logo are trademarks of ST. All other product or service names are the property of their respective owners.

Information in this document supersedes and replaces information previously supplied in any prior versions of this document.

© 2016 STMicroelectronics – All rights reserved

Mouser Electronics

Authorized Distributor

Click to View Pricing, Inventory, Delivery & Lifecycle Information:

[STMicroelectronics:](#)

[STTH506D](#)