

## UFE / UFR Series

Up to 6000 Watts

### Data Sheet

**Total Power:** Up to 6000 W  
**Input Voltage:** 85 - 264 Vac  
**# of Outputs:** Single + Aux  
**Output:** 48V



### SPECIAL FEATURES

- Rack mounted chassis (1U, 19")
- Three hot pluggable rectifiers per 1U chassis, up to 4 kW redundant or 6 kW available power (180 - 264 Vac input)
- Up to 2.6 kW redundant or 3.9 kW available/shelf at 90 - 132 Vac input
- Stackable to 6U high to provide up to 36 kW available power
- Class B conducted EMI EN55022 (See Note 1)
- Automatic fan speed control with fault reporting
- Auxiliary standby output, 11 V at approximately 2.8 W
- High density up to 22 W/in<sup>3</sup>
- High efficiency up to 91%
- Floating as well as isolated main output voltage allows positive or negative polarity operation
- EU directive 2002/95/EC compliant for RoHS
- PMBus compliant
- Two-year warranty

### SAFETY

- VDE EN/IEC60950-1
- UL/cUL60950-1

### Electrical Specifications

Input		
Output power	Main output Auxiliary output	See Table 1 11 V ± 15%, 2.875 W
Line regulation	Low line to high line	± 0.15% max.
Load regulation (active share mode)	Full load to minimum load	± 0.15% max.
Turn-on delay	(See Note 4)	5.0 s max.
Ambient temperature co-efficient	At full load, min. Vin	± 0.005% / °C
Voltage adjustability: Adjustable PMBus command (See Note 6)	48 Vout	42 - 57 Vdc
Output setpoint accuracy		± 0.5%
Default output voltage: Setting 25 °C	48 Vout (active default)	48 V ± 0.5% @ 41 A
Voltage droop: (Operation set PMBus command)	48 Vout	80.6 mV / A ± 3.0% from 10 A up to power limit
Total error band	-40 °C to +70 °C, FL range	± 1.0% max.
Overshoot/undershoot	Main output @ turn-on/off	0% / 0%
Ripple and noise (20 MHz)	Main output, -5 °C and above Auxiliary output	500 mV pk-pk, 150 mV rms 400 mV pk-pk, 150 mV rms
Dynamic regulation (except droop mode)	Peak dev., 25% load step Recovery time	2.5% max. 1 ms max.
Current sharing (See Note 3)	(I1-I2) / ILIMIT x 100	± 15% max.

### Documentation

Appendix A	<i>UFR6000 Platform Specification</i>
Appendix B	<i>Application Note 210: I<sup>2</sup>C Serial Bus Interface</i>
Appendix C	<i>Application Note 211: PMBus Commands</i>
Appendix D	<i>Application Note 212: Feature, Functions, EMC and Safety</i>
Appendix E	<i>Technical Reference - Rack and Unit Notes</i>
Appendix F	<i>Application Note: Rack and Unit Connections</i>

All specifications are typical at nominal input, full load at 25 °C ambient unless otherwise stated.

## Electrical Specifications

Input		
Input voltage range (See Note 2)		88 - 264 Vac 176 - 264 Vac
Input frequency range		47 - 63 Hz
Input current		15 A max.
Ground leakage current	AC to safety ground	2 mA max
Input fuse (internal)	Both lines fused	30 A
Power factor	50 to 100% load	0.98
Undervoltage lockout (Power up)	High line range Wide line range	176 Vac max. 88 Vac max.
Undervoltage lockout (Power down)	High line range	162 Vac min. LED warning @ 176 V max.
	Wide line range	76 Vac min. LED warning @ 88 V max.
General Specifications		
Electrical insulation	Input/output Input/chassis	3000 Vac / 4242 Vdc 1500 Vac / 2121 Vdc
Switching frequency	Fixed	450 kHz
Approvals and standards		VDE EN/IEC60950-1 UL/cUL60950-1
Weight		5.5 lbs
Hold-up time	48 Vout at rated output power	20 ms min.
MTBF (@25 °C)	Telcordia SR-332 Issue 1	279,069 hours
Acoustical noise	Over all conditions 25 °C ambient at rated output power	71 dB max. 58 dB typ.
EMC		
Conducted emissions	EN55022, FCC part 15	Class B (when installed in system)
Immunity		
- Harmonic current	EN61000-3-2	Compliant
- ESD air/contact	EN61000-4-2	Level 3
- Surge	EN61000-4-5	
- Fast transients	EN61000-4-4	Level 3
- Flicker	EN61000-3-3	Compliant
- Magnetic field	EN61000-4-8	Compliant
- Radiated immunity	EN61000-4-3	Level 3
- Conducted immunity	EN61000-4-6	Level 3

Notes:

1. Final EMI performance is system/shelf dependent.
2. Auto ranging sets power limit based on input voltage at turn on.
3. The difference in output current among any two rectifiers operating in parallel does not exceed a value equal to 15% of the rated current limit. This specification applies for operation with any output current from no load to 110% of maximum.
4. Maximum 15 minute warm up time at light loads below -15 °C. See Application Note 212 for cold start timing data.
5. For operation above 1,524 m (5,000 ft), maximum operation temperature is derated by 2 °C per 305 m (1,000 ft).
6. Output voltage can be modified on the fly between 42-57V (48V model) PMBus command.
7. Unit and rack are conformal coated.

## Environmental Specifications

Thermal performance (See Note 4 and derating curves)	Operating Non-operating Cold start	-33 °C to +70 °C -40 °C to +100 °C -40 °C
Relative humidity (non-condensing)	Operating Non-operating	Up to 80% Up to 95%
Altitude (See Note 5)	Operating Non-operating	10,000 feet max. 35,000 feet max.
Vibration	Operating Non-operating	1.0 G peak 1.5 G peak
Shock	Operating Non-operating	10 G peak / 11 ms 40G peak / 11 ms

### Protection

Power limit (Vo > Vout min.)		± Rated power +15% / -0%
Current limit	Constant current limiting - brickwall: Vo <sup>2</sup> Vout min.	± limit, ± 8%
Short circuit	Hiccup mode at Vo < 40 Vdc	200 ms on / 1/8 s off
Overvoltage	Output shutdown Latching after 1 retry	60 V max.
Thermal	Self protecting	Non-latching
OR-ing fault (See Note 7)	Tested via I <sup>2</sup> C or PMBus	LED alarm (by read) in case of OR-ing fault

### Communication Monitoring Readout Accuracy

Current	Valid from 15% to max. load	± 15%
Voltage	Measured before output OR-ing	± 5%
Temperature	Measured internal output OR-ing	± 5 °C
Hours counter		± 36 s/hours approx.

## Module Ordering Information

Model Number	Rated Output Power	Output Voltage		Output Current (min)	Power Limit +15% / -0% Vout (min)	Line range at Turn-on (Auto Ranging)	Operating Line Range	Current Limit (Vout) < Vout (min)
		Min	Max					
UFE2000-96S48PDMJ	1300 W	42 V	57 V	0 A	1300 W	90 - 264 Vac	33 A	33 A
	2000 W	42 V	57 V	0 A	2000 W	180 - 264 Vac	52 A	52 A

## Rack Ordering Information

Rack Model Number	Hot Plug Interface	Number of Power Modules per Pack
UFR6000-00MJ	Yes	3
UFR6000PJ	Blank panel	3

## Part Number System with Options

Product Family	Rated Output Power	Input Range	Standard Compliance	Type of Output	Output Voltage	Comm Type	Option Code	Special Modification	RoHS Compliance <sup>9</sup>
<b>UFE</b>	<b>2000</b>	<b>9</b>	<b>6</b>	<b>S</b>	<b>48</b>	<b>P</b>	<b>D</b>	<b>M</b>	<b>J</b>
UFE = Universal front end	1300 = 1300 W 2000 = 2000 W	9 = Universal Input with PFC	6 = UL/CSA/VDE Class A/B	S = Single	24 = 24 V 48 = 48 V	C1 = I <sup>2</sup> C serial communication P = PMBus serial communication	None = Active Ishare D = Droop Ishare HD = PS Enable HI/Droop	M = Motorola	J = Pb free (RoHS 6/6 compliant)

Mechanical Drawing

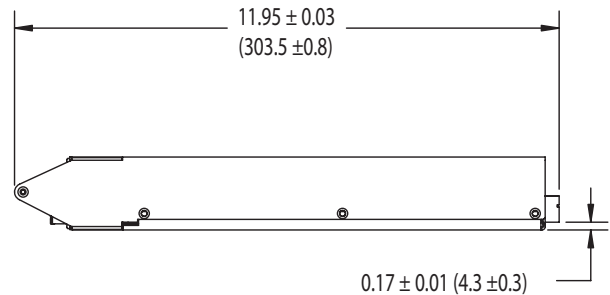
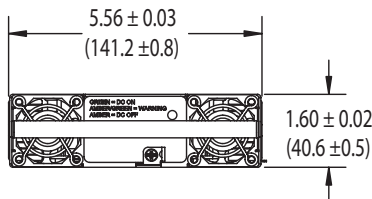
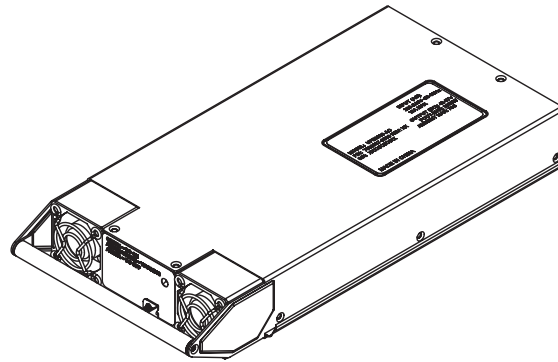
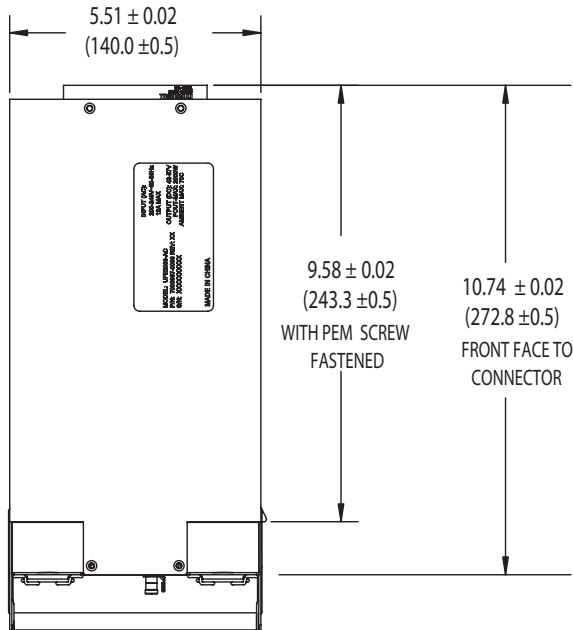

Dimensions in Inches (mm)

Power Supply Connector	Mating Connector
Molex: 87663-4006	Molex: 87664-2004
Tyco: 2-1450330-8	Tyco: 1450370-5
FCI Bert: 51939-180	FCI Berg: 51915-070

Power Supply Connector Pinout					
Pin	D	C		B	A
P1	L1				
P2	L2				
P3	PEG				
1	Sense-	Sense+		GND	Shortpin
2	Present-L	GND		PS-ID0	GND
3	PS-ID3	PS-ID2		GND	12V-AUX
4	GND	SCL		PS-ID1	GND
5	SDA	GND		GND	PC-En-H (Comm-EN-H)
6	SMBALERT#	Ishare		DC-OK-L	PS-EN (Control)
P4	DC-N				
P5	DC_N				
P6	DC_P				
P7	DC_P				

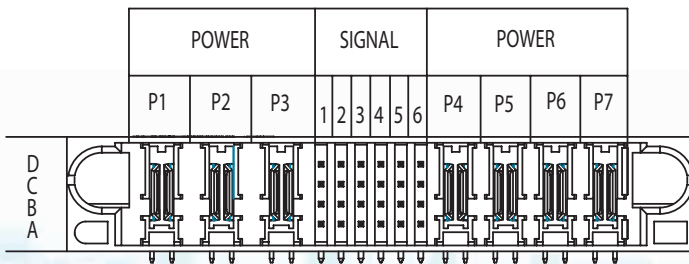

Power Connections Layout  
(Looking into Connector Side of UFE Power Supply)

## Rack Specifications

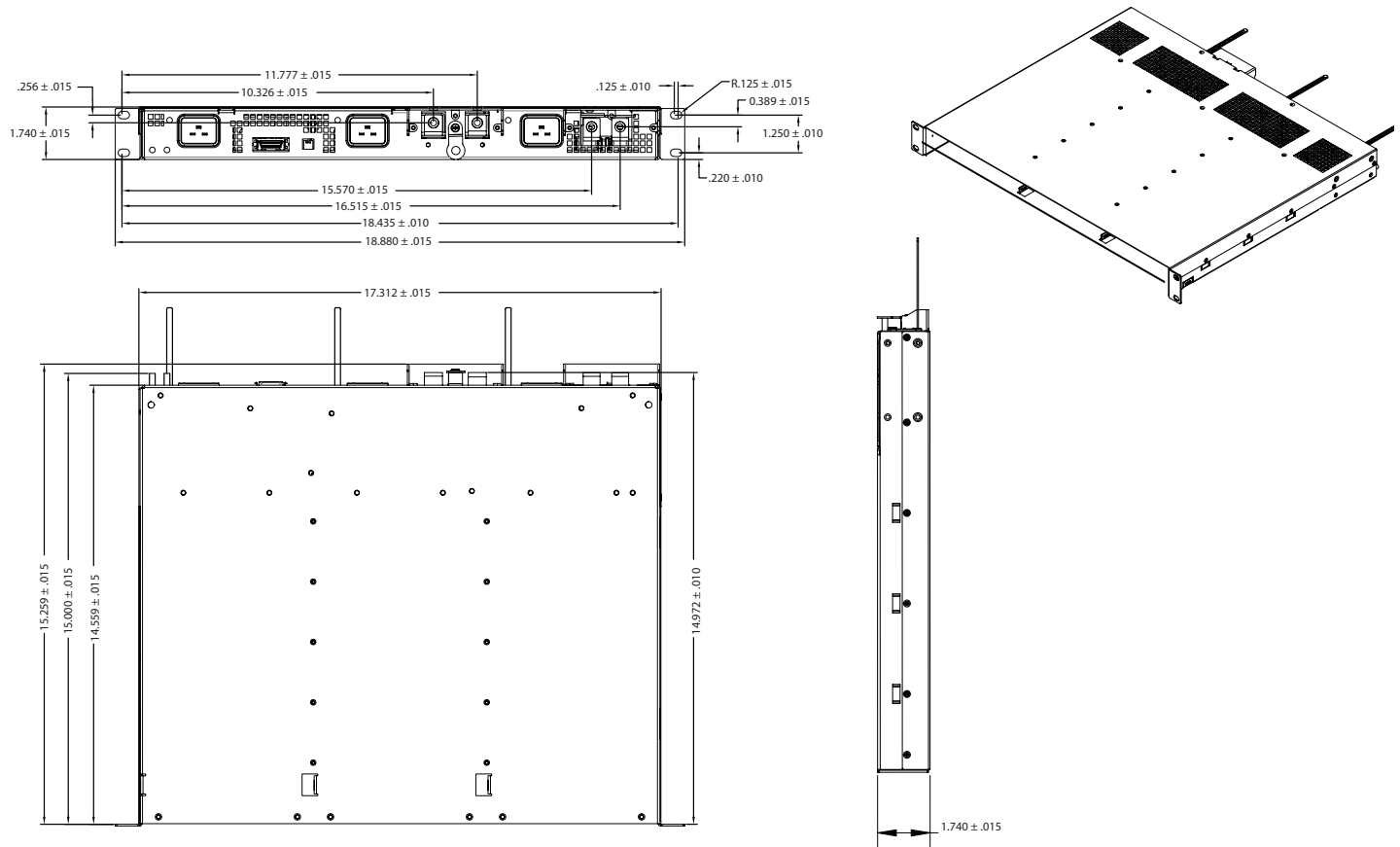

Rack Signal Connector Pinout			
Pin	Function	Pin	Function
1	48 V Sense+	14	48 V Ishare
2	Ground	15	Unit 1 Present
3	48 V Sense-	16	Ground
4	Ground	17	Unit 2 Present
5	PS-EN (Control)	18	Ground
6	DC1-OK0-L	19	Unit 3 Present
7	DC2-OK-L	20	Ground
8	DC3-OK-L	21	SCL
9	I <sup>2</sup> C-En-H-1 (Comm-En-H)	22	Ground
10	I <sup>2</sup> C-En-H-2 (Comm-En-H)	23	SDA
11	I <sup>2</sup> C-En-H-3 (Comm-En-H)	24	Ground
12	Ground	25	SMBALERT#
13	12 V-Aux	26	N/C

Signal Connector (1 per shelf)	
Shelf Connector	Mating Connector
Molex: 52986-2679	Molex: 52316-2619
Tyco: 2-178238-4	Tyco: 2-5175677-4

AC Input Connector (3 per shelf)	
Shelf Connector	Mating Connector
IEC320 C20 Socket	IEC320 C20 Plug (Straight Entry)

Shelf DIP Switch Table		
Shelf Number	DIP Switch	DIP Switch
1	Up	Up
2	Up	Down
3	Down	Up
4	Down	Down

## Derating Curves

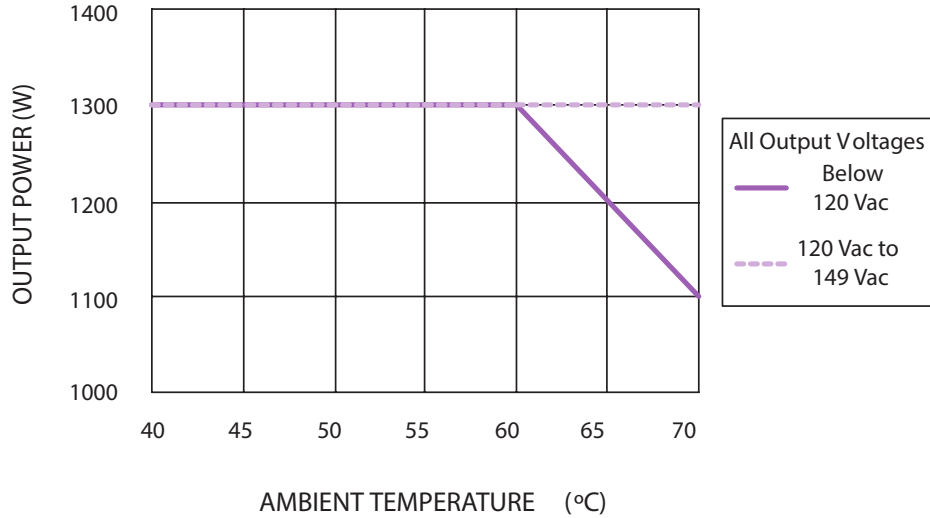

Figure 1 - Thermal Derating Curve for UFE2000-96S48J Model Low Line Input Voltage

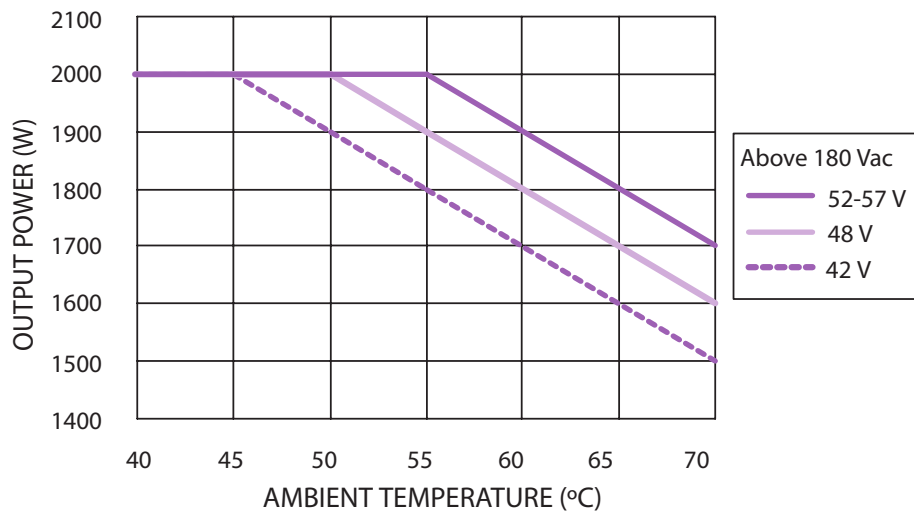

Figure 2 - Thermal Derating Curve for UFE2000-96S48J Model High Line Input Voltage

### WORLDWIDE OFFICES

#### Americas

2900 South Diablo Way  
Suite B100  
Tempe, AZ 85282, USA  
+1 888 412 7832

#### Europe (UK)

Ground Floor Offices, Barberry House  
4 Harbour Buildings, Waterfront West  
Brierley Hill, West Midlands  
DY5 1LN, UK  
+44 (0) 1384 842 211

#### Asia (HK)

14/F, Lu Plaza  
2 Wing Yip Street  
Kwun Tong, Kowloon  
Hong Kong  
+852 2176 3333

**ARTESYN**<sup>TM</sup>  
An Advanced Energy Company

[www.artesyn.com](http://www.artesyn.com)

Artesyn Embedded Technologies, Artesyn Embedded Power, Artesyn, and all Artesyn related logos are trademarks and service marks of Artesyn Embedded Technologies, Inc. All other names and logos referred to are trade names, trademarks, or registered trademarks of their respective owners. Specifications are subject to change without notice. © 2019 Artesyn Embedded Technologies, Inc. All rights reserved. For full legal terms and conditions, please visit [www.artesyn.com/legal](http://www.artesyn.com/legal).

For more information: [www.artesyn.com](http://www.artesyn.com)  
For support: [productsupport.ep@artesyn.com](mailto:productsupport.ep@artesyn.com)