



Features

- Incremental encoder / quadrature output
- Exceptionally long operating life
- Sturdy construction
- Bushing mount
- Available with PC board mounting bracket (optional)
- RoHS compliant*

ECW - Digital Contacting Encoder

Electrical Characteristics

Output.....	2-bit quadrature code, Channel A leads Channel B by 90 ° electrically turning clockwise (CW)
Closed Circuit Resistance.....	5 ohms maximum
Open Circuit Resistance.....	100 K ohms minimum
Contact Rating.....	10 milliamp @ 10 VDC or 0.1 watt maximum
Insulation Resistance (500 VDC).....	1,000 megohms minimum
Dielectric Withstanding Voltage (MIL-STD-202 Method 301)	
Sea Level.....	1,000 VAC minimum
Electrical Travel.....	Continuous
Contact Bounce (15 RPM).....	5 milliseconds maximum
RPM (Operating).....	120 maximum
Phase Tolerance (CH A to CH B).....	90 ° ± 72 °

Environmental Characteristics

Operating Temperature Range.....	-40 °C to +85 °C (-40 °F to 185 °F)
Storage Temperature Range.....	-40 °C to +85 °C (-40 °F to +185 °F)
Humidity.....	MIL-STD-202, Method 103B, Condition B
Vibration.....	15 G
Contact Bounce.....	0.1 millisecond maximum
Shock.....	50 G
Contact Bounce.....	0.1 millisecond maximum
Rotational Life.....	200,000 shaft revolutions
IP Rating.....	IP 40

Mechanical Characteristics

Mechanical Angle.....	Continuous
Running Torque (Detented).....	0.5 to 1.5 N-cm (0.75 to 2.25 oz-in.)
Undetented Torque.....	0.17 to 1.0 N-cm (0.25 to 1.50 oz-in)
Mounting Torque.....	79 N-cm (7 lb.-in.) maximum
Shaft Side Load (Static).....	4.5 kg (10 lbs.) minimum
Weight.....	Approximately 21 gms. (0.75 oz.)
Terminals.....	PC pin or solder lug
Soldering Condition	
Manual Soldering.....	96.5Sn/3.0Ag/0.5Cu solid wire or no-clean rosin cored wire 370 °C (700 °F) max. for 3 seconds
Wave Soldering.....	96.5Sn/3.0Ag/0.5Cu solder with no-clean flux 260 °C (500 °F) max. for 5 seconds
Wash processes.....	Not recommended
Marking.....	Manufacturer's name and trademark, part number, and date code.
Hardware.....	One lockwasher and one mounting nut are shipped with each encoder, except where noted in the part number.

Quadrature Output Table – This table is intended to show available outputs as currently defined.



RECOMMENDED INCREMENTAL CONTROL DIAGRAM FOR USE WITH A DEBOUNCE CIRCUIT



*RoHS Directive 2002/95/EC Jan. 27, 2003 including annex and RoHS Recast 2011/65/EU June 8, 2011.

Specifications are subject to change without notice.

The device characteristics and parameters in this data sheet can and do vary in different applications and actual device performance may vary over time. Users should verify actual device performance in their specific applications.

ECW - Digital Contacting Encoder

BOURNS®

Dimensional Drawings

BUSHING MOUNTED - HOUSING A Rear-Facing Terminals



PANEL HOLE DIMENSIONS Bushing Mounted



PCB BRACKET MOUNTED - HOUSING B Dimensions not given are the same as Bushing Mounted.

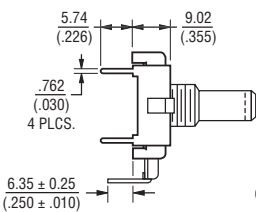

PCB MOUNTING DIMENSIONS (Housing Styles B and E)

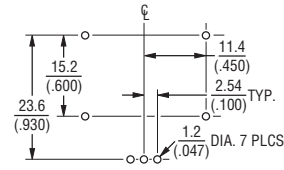

SOLDER HOLES - HOUSING C Dimensions not given are the same as Bushing Mounted.

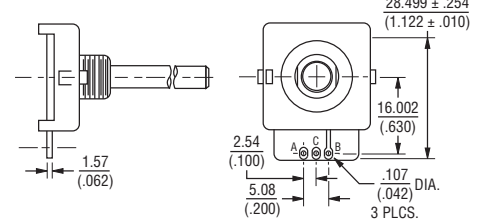

SNAP-IN MOUNT - Housing G

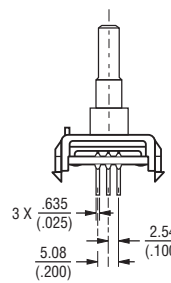
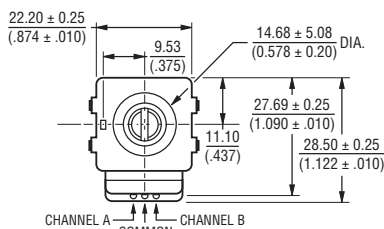
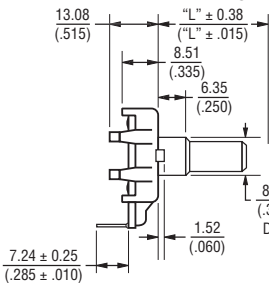

PCB MOUNTING DIMENSIONS

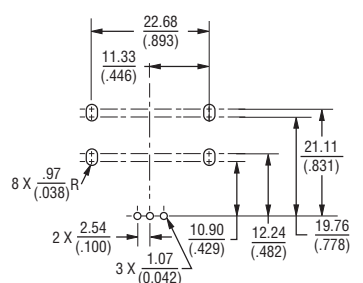

Shaft Style B

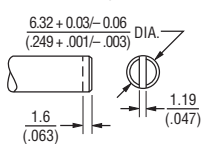

Shaft Style C



"D" DIMENSION EXTENDS FROM SHAFT END TO BUSHING FACE
"D" = (SHAFT LENGTH, FMS) - (BUSHING LENGTH)

Shaft Style J



Shaft Style R

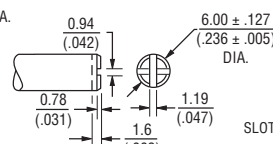

Shaft Style Y

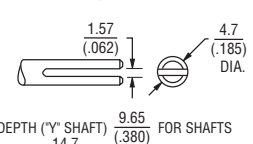

BUSHING MOUNTED - HOUSING H Front-Facing Terminals

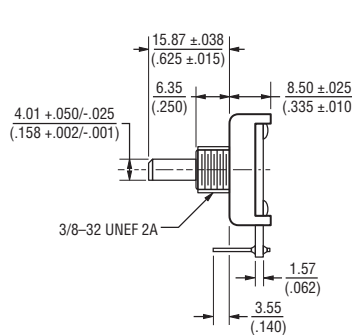
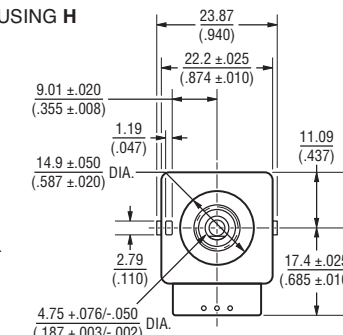
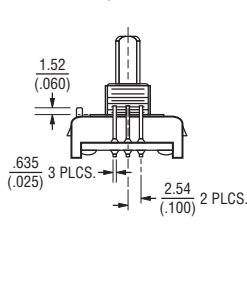

FOR TOLERANCES NOT SHOWN

.XX ± .25 (.010) .XXX ± .13 (.005)
SHAFT DIMENSIONS ± 1/32"

DIMENSIONS: MM (IN)

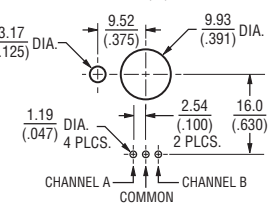

Specifications are subject to change without notice.

The device characteristics and parameters in this data sheet can and do vary in different applications and actual device performance may vary over time. Users should verify actual device performance in their specific applications.

ECW - Digital Contacting Encoder

BOURNS®

How to Order

PART NUMBERING SYSTEM

E C W 1 J - B 2 4 - B C 0 0 2 4 L

Code	Rotational Life
C	200,000 Revolutions

BUSHING CONFIGURATION	
Code	Description
W	9 mm x 1/4 " Length. Threaded M9x0.75
L	9 mm x 3/8 " Length. Threaded M9x0.75 (Use B shaft only.)
T	9 mm x 1/4 ". No Thread.

SWITCHING CONFIGURATION (In Detent Position)	
Applies to performance codes B0012 and C0024 only, use code "0" for all other performance codes.	
Code	Description
0	Not Applicable
1	Normally Open

ANTI-ROTATION LUG POSITION	
Code	Description
J	9:00 Position
D	None

SHAFT STYLE (See Outline Drawing for Details)	
Code	Description
B	Plain with Inserted Slot (1/4 " Dia.)
C	Single Flatted (1/4 " Dia.)
R	Plain with Cross Slot (6 mm Dia.)
Y	Split Shaft Version (.185 " Dia.)
J	Flatted Shaft (3/16 " Dia.)

RoHS IDENTIFIER	
Code	Description
L	Compliant

PERFORMANCE CODE		
Code	Detents	Cycles/Rev.
E0006	0	6
E0009	0	9
E0012	0	12
E0024	0	24
E0036	0	36
B0012	12	12
C0006	24	6
C0024		24
D0009	36	9

HOUSING TERMINAL CONFIGURATION (X indicates "Equipped With")										
Code										
Features	A	B	C	D	E	F	G*	H	K	
Terminal Cover	X	X			X		X			
Rear-Facing Terminals	X	X			X		X			
Solder Holes			X	X		X				
PCB Bracket		X		X	X	X				
Hardware Included	X		X		X	X		X		
Snap-In Mount								X		
Forward-Facing Terminals									X	X

*Bushing code T only.

SHAFT LENGTH (FMS)		
Code	Description	Available Shaft Styles
16	1/2 " Length	B
20	5/8 " (15.9 mm) Length	J
24	3/4 " (19 mm) Length	B, C, J, Y
28	7/8 " (22.2 mm) Length	B, C, J, Y
32	1 " (25.4 mm) Length	B, C, J, Y
36	1-1/8 " (28.6 mm) Length	B, C, J, Y
Metric		
19	19 mm Length	R
22	22 mm Length	R
24	24 mm Length	R

The sample part number demonstrates the identification code for Bourns contacting encoders.

Boldface features are Bourns standard options. All others are available with higher minimum order quantities.

REV. 02/15

Specifications are subject to change without notice. The device characteristics and parameters in this data sheet can and do vary in different applications and actual device performance may vary over time. Users should verify actual device performance in their specific applications.

Mouser Electronics

Authorized Distributor

Click to View Pricing, Inventory, Delivery & Lifecycle Information:

Bourns:

[ECW0J-C24-EE0024](#) [ECT1D-C36-GC0024](#) [ECT0D-J24-GD0009](#) [ECT0D-J32-GD0009](#) [ECW0J-C24-CC0006](#)
[ECW0J-C28-CC0006](#) [ECW1J-C24-CC0024](#) [ECW1J-C28-CC0024](#) [ECL0J-C24-CC0006](#) [ECW1D-R19-BC0024](#)
[ECW1D-R24-BC0024](#) [ECW0J-C24-BE0036](#) [ECW0J-C24-BE0006](#) [ECW0J-C24-BE0024](#) [ECW1J-B24-HB0012](#)
[ECW1J-C36-CC0024](#) [ECW1J-B36-EC0024](#) [ECW0J-C32-CC0006](#) [ECW0J-C24-ED0009](#) [ECW0J-B24-CD0009](#)
[ECW0J-R19-BE0024](#) [ECW0J-B16-BE0024](#) [ECW1D-C24-EB0012](#) [ECW1J-R24-BB0012](#) [ECW0J-R24-CE0006](#)
[ECW0D-J24-BE0024](#) [ECW1J-B24-BB0012](#) [ECW1J-B28-BB0012](#) [ECW0J-R24-BC0006](#) [ECW0J-R19-BC0006](#)
[ECW1J-R19-BC0024](#) [ECW0J-B24-AD0009](#) [ECW1J-B24-CB0012](#) [ECW0J-B32-AD0009](#) [ECW0D-J20-BC0006](#)
[ECW1J-B16-BC0024](#) [ECW1J-R24-CB0012](#) [ECT0D-B16-GE0024](#) [ECW0J-B24-AC0006](#) [ECW0J-C24-BC0006](#)
[ECW1J-B28-AC0024](#) [ECW1J-C24-BC0024](#) [ECW1J-B24-AC0024](#) [ECW1J-C28-BC0024](#) [ECW0J-R29-AC0006](#)
[ECW1J-B28-AB0012](#) [ECW1D-C36-BC0024](#) [ECW1D-C32-BC0024](#) [ECW1J-C28-CB0012](#) [ECW1J-C24-CB0012](#)
[ECT2D-B16-GC0024](#) [ECW0J-B36-BD0009](#) [ECW0D-B36-CC0006](#) [ECW0J-B32-CE0009](#) [ECW0J-B24-CE0006](#)
[ECW1D-C24-CC0024](#) [ECW1D-B16-EC0024](#) [ECL0D-B32-EC0006](#) [ECW0D-C28-EC0006](#) [ECW1D-C24-EC0024](#)
[ECW1J-R24-CC0024](#) [ECW0J-B32-BC0006](#) [ECW0D-B24-AE0024](#) [ECW0D-C24-BE0024](#) [ECW0D-B24-BC0006](#)
[ECL1D-B24-BC0024](#) [ECW0D-B28-BC0006](#) [ECW1D-B24-BC0024](#) [ECW1J-R24-EC0024](#) [ECW0J-J24-BC0006](#)
[ECW1J-R29-EC0024](#) [ECW0J-R24-EC0006](#) [ECW0D-B24-EC0006](#) [ECW0J-B24-AE0024](#) [ECW0J-B24-AE0006](#)
[ECT1J-R24-GC0024](#) [ECW1D-B24-CC0024](#) [ECW0D-B16-BE0024](#) [ECW1J-C28-BB0012](#) [ECW1J-C24-BB0012](#)
[ECW1J-B16-AC0024](#) [ECW1J-R24-AC0024](#) [ECW0D-B28-BE0024](#) [ECW0D-B24-BE0024](#) [ECW0J-R24-AE0012](#)
[ECW0J-B32-CD0009](#) [ECL1J-B24-CC0024](#) [ECW1D-J24-BB0012](#) [ECW0J-B24-CC0006](#) [ECW1J-B24-CC0024](#)
[ECW0D-C24-AD0009](#) [ECW1J-B36-BC0024](#) [ECW1J-B32-BC0024](#) [ECW0J-B36-BC0006](#) [ECW1J-R19-AC0024](#)
[ECW0J-R24-CE0024](#) [ECW1J-J24-AC0024](#) [ECW1J-C32-BC0024](#) [ECW1J-B36-AC0024](#) [ECW1J-R24-AB0012](#)