

CC1125 Ultra-High Performance RF Narrowband Transceiver

1 Device Overview

1.1 Features

- High-Performance, Single-Chip Transceiver
 - Adjacent Channel Selectivity: 67 dB at 6.25-kHz Offset
 - Blocking Performance: 104 dB at 10 MHz
 - Excellent Receiver Sensitivity
 - –129 dBm at 300 bps
 - –123 dBm at 1.2 kbps
 - –110 dBm at 50 kbps
 - Very Low Phase Noise: –115 dBc/Hz at 10-kHz Offset
- Suitable for Systems Targeting ETSI Category 1
- Separate 128-Byte RX and TX FIFOs
- Support for Seamless Integration With the CC1190 Device for Increased Range Giving up to 3-dB Improvement in Sensitivity and up to +27-dBm Output Power
- High Spectral Efficiency (9.6 kbps in 12.5-kHz Channel in Compliance With FCC Narrowbanding Mandate)
- Power Supply
 - Wide Supply Voltage Range (2.0 V to 3.6 V)
 - Low Current Consumption:
 - RX: 2 mA in RX Sniff Mode
 - RX: 17 mA Peak Current in Low-Power Mode
 - RX: 26 mA Peak Current in High-Performance Mode
 - TX: 47 mA at +14 dBm
 - Power Down: 0.12 μ A (0.5 μ A With Enhanced Wake-On-Radio (eWOR) Timer Running)
- Programmable Output Power up to +16 dBm With 0.4-dB Step Size
- Automatic Output Power Ramping
- Configurable Data Rates: 0 to 200 kbps
- Supported Modulation Formats: 2-FSK, 2-GFSK, 4-FSK, 4-GFSK, MSK, OOK
- WaveMatch: Advanced Digital Signal Processing for Improved Sync Detect Performance
- RoHS-Compliant 5-mm x 5-mm No-Lead QFN 32-Pin Package (RHB)
- Regulations – Suitable for Systems Targeting Compliance With
 - **Europe:** ETSI EN 300 220 Category 1, ETSI EN 54-25, ETSI EN 300 113, and EN 301 166
 - **US:** FCC CFR47 Part 15, 24, 90, 101
 - **Japan:** ARIB RCR STD-T30, T-67, T-108
- Peripherals and Support Functions
 - eWOR Functionality for Automatic Low-Power Receive Polling
 - Includes Functions for Antenna Diversity Support
 - Support for Retransmissions
 - Support for Auto-Acknowledge of Received Packets
 - TCXO Support and Control, also in Power Modes
 - Automatic Clear Channel Assessment (CCA) for Listen-Before-Talk (LBT) Systems
 - Built-in Coding Gain Support for Increased Range and Robustness
 - Digital RSSI Measurement
 - Temperature Sensor

1.2 Applications

- Social Alarms
- Narrowband Ultra-Low-Power Wireless Systems With Channel Spacing Down to 4 kHz
- 169-, 315-, 433-, 868-, 915-, 920-, 950-MHz ISM/SRD Band Systems
- Wireless Metering and Wireless Smart Grid (AMR and AMI)
- IEEE 802.15.4g Systems
- Home and Building Automation
- Wireless Alarm and Security Systems
- Industrial Monitoring and Control
- Wireless Healthcare Applications
- Wireless Sensor Networks and Active RFID
- Private Mobile Radios



1.3 Description

The CC1125 device is a fully integrated single-chip radio transceiver designed for high performance at very low-power and low-voltage operation in cost-effective wireless systems. All filters are integrated, thus removing the need for costly external SAW and IF filters. The device is mainly intended for the ISM (Industrial, Scientific and Medical) and SRD (Short Range Device) frequency bands at 164–192 MHz, 274–320 MHz, 410–480 MHz, and 820–960 MHz.

The CC1125 device provides extensive hardware support for packet handling, data buffering, burst transmissions, clear channel assessment, link quality indication, and Wake-On-Radio. The main operating parameters of the CC1125 device can be controlled through an SPI interface. In a typical system, the CC1125 device will be used with a microcontroller and only a few external passive components.

Device Information⁽¹⁾

PART NUMBER	PACKAGE	BODY SIZE
CC1125RHB	VQFN (32)	5.00 mm x 5.00 mm

(1) For more information, see [Section 8, Mechanical Packaging and Orderable Information](#)

1.4 Functional Block Diagram

Figure 1-1 shows the system block diagram of the CC1125 device.

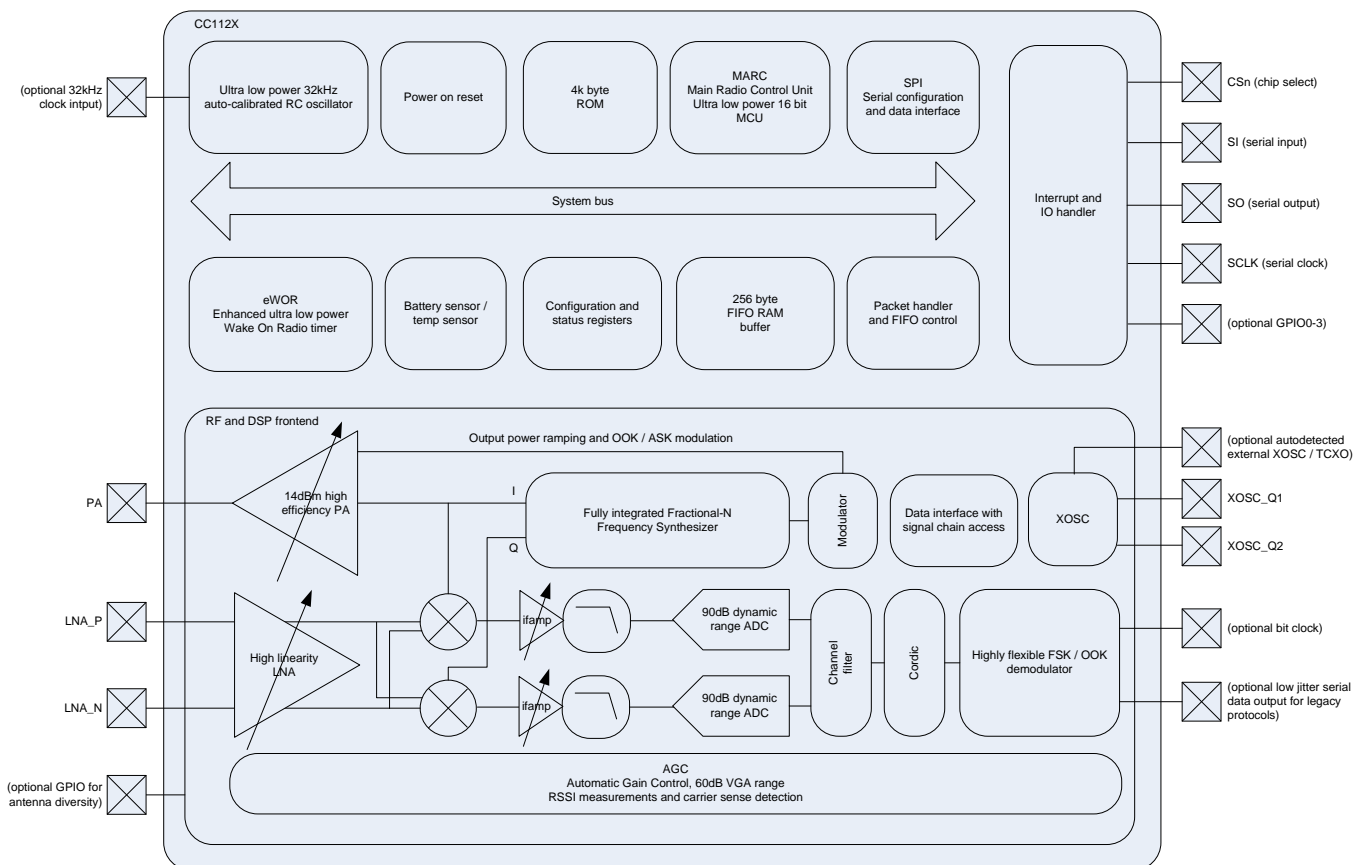

Figure 1-1. Functional Block Diagram

Table of Contents

1 Device Overview 1	
1.1 Features 1	4.15 High-Speed Clock Input (TCXO) 19
1.2 Applications 1	4.16 32-kHz Clock Input 19
1.3 Description 2	4.17 Low Speed RC Oscillator 20
1.4 Functional Block Diagram 2	4.18 I/O and Reset 20
2 Revision History 4	4.19 Temperature Sensor 20
3 Terminal Configuration and Functions 5	4.20 Typical Characteristics 21
3.1 Pin Diagram 5	5 Detailed Description 24
3.2 Pin Configuration 6	5.1 Block Diagram 24
4 Specifications 7	5.2 Frequency Synthesizer 24
4.1 Absolute Maximum Ratings 7	5.3 Receiver 25
4.2 Handling Ratings 7	5.4 Transmitter 25
4.3 Recommended Operating Conditions (General Characteristics) 7	5.5 Radio Control and User Interface 25
4.4 Thermal Resistance Characteristics for RHB Package 7	5.6 4.5 Enhanced Wake-On-Radio (eWOR) 25
4.5 RF Characteristics 8	5.7 Sniff Mode 26
4.6 Regulatory Standards 8	5.8 Antenna Diversity 26
4.7 Current Consumption, Static Modes 9	5.9 WaveMatch 27
4.8 Current Consumption, Transmit Modes 9	6 Typical Application Circuit 28
4.9 Current Consumption, Receive Modes 10	7 Device and Documentation Support 29
4.10 Receive Parameters 11	7.1 Device Support 29
4.11 Transmit Parameters 17	7.2 Documentation Support 30
4.12 PLL Parameters 18	7.3 Community Resources 30
4.13 Wake-up and Timing 19	7.4 Trademarks 30
4.14 High-Speed Crystal Oscillator 19	7.5 Electrostatic Discharge Caution 30
	7.6 Glossary 30
	8 Mechanical Packaging and Orderable Information 31

2 Revision History

NOTE: Page numbers for previous revisions may differ from page numbers in the current version.

This data manual revision history highlights the changes made to the SWRS120D device-specific data manual to make it an SWRS120E revision.

Changes from Revision D (June 2014) to Revision E	Page
• Added Ambient to the temperature range condition and removed Tj from Temperature range	7
• Added data to TCXO table	19

3 Terminal Configuration and Functions

3.1 Pin Diagram

Figure 3-1 shows pin names and locations for the CC1125 device.

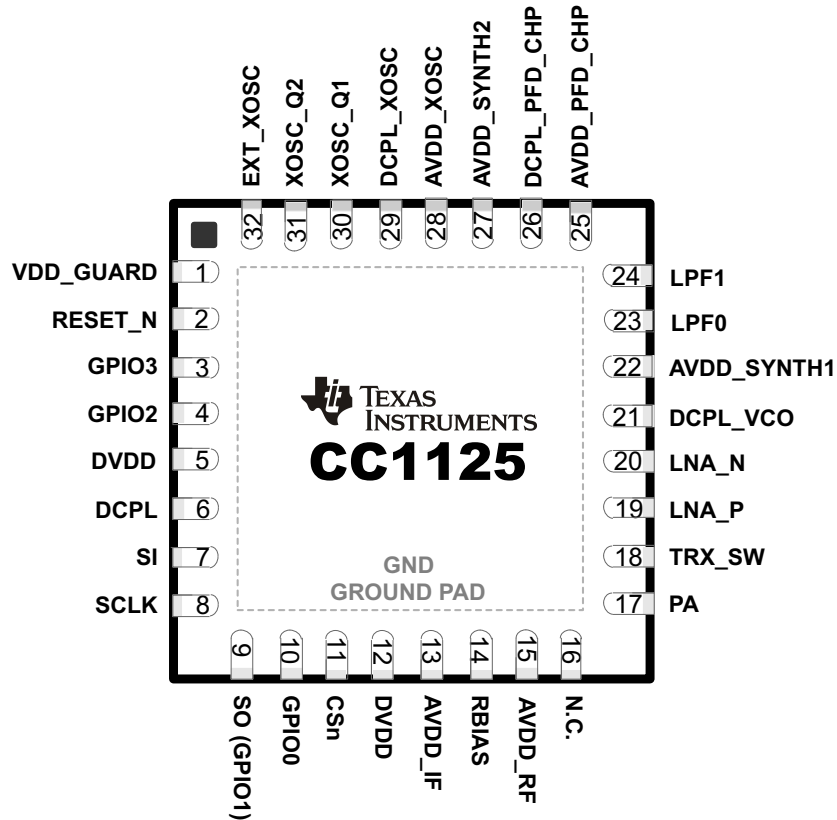

Figure 3-1. Package 5-mm x 5-mm QFN

3.2 Pin Configuration

The following table lists the pin-out configuration for the CC1125 device.

PIN NO.	PIN NAME	TYPE / DIRECTION	DESCRIPTION
1	VDD_GUARD	Power	2.0–3.6 V VDD
2	RESET_N	Digital input	Asynchronous, active-low digital reset
3	GPIO3	Digital I/O	General-purpose I/O
4	GPIO2	Digital I/O	General-purpose I/O
5	DVDD	Power	2.0–3.6 VDD to internal digital regulator
6	DCPL	Power	Digital regulator output to external decoupling capacitor
7	SI	Digital input	Serial data in
8	SCLK	Digital input	Serial data clock
9	SO(GPIO1)	Digital I/O	Serial data out (general-purpose I/O)
10	GPIO0	Digital I/O	General-purpose I/O
11	CSn	Digital input	Active-low chip select
12	DVDD	Power	2.0–3.6 V VDD
13	AVDD_IF	Power	2.0–3.6 V VDD
14	RBIAS	Analog	External high-precision resistor
15	AVDD_RF	Power	2.0–3.6 V VDD
16	N.C.		Not connected
17	PA	Analog	Single-ended TX output (requires DC path to VDD)
18	TRX_SW	Analog	TX and RX switch. Connected internally to GND in TX and floating (high-impedance) in RX.
19	LNA_P	Analog	Differential RX input (requires DC path to GND)
20	LNA_N	Analog	Differential RX input (requires DC path to GND)
21	DCPL_VCO	Power	Pin for external decoupling of VCO supply regulator
22	AVDD_SYNT1	Power	2.0–3.6 V VDD
23	LPF0	Analog	External loop filter components
24	LPF1	Analog	External loop filter components
25	AVDD_PFD_CHP	Power	2.0–3.6 V VDD
26	DCPL_PFD_CHP	Power	Pin for external decoupling of PFD and CHP regulator
27	AVDD_SYNT2	Power	2.0–3.6 V VDD
28	AVDD_XOSC	Power	2.0–3.6 V VDD
29	DCPL_XOSC	Power	Pin for external decoupling of XOSC supply regulator
30	XOSC_Q1	Analog	Crystal oscillator pin 1 (must be grounded if a TCXO or other external clock connected to EXT_XOSC is used)
31	XOSC_Q2	Analog	Crystal oscillator pin 2 (must be left floating if a TCXO or other external clock connected to EXT_XOSC is used)
32	EXT_XOSC	Digital input	Pin for external clock input (must be grounded if a regular crystal connected to XOSC_Q1 and XOSC_Q2 is used)
–	GND	Ground pad	The ground pad must be connected to a solid ground plane.

4 Specifications

All measurements performed on CC1120EM_868_915 rev.1.0.1, CC1120EM_955 rev.1.2.1, CC1120EM_420_470 rev.1.0.1 or CC1120EM_169 rev.1.2 ($f_{\text{xosc}} = 32$ MHz), and CC1125EM_868_915 rev.1.1.0, CC1125EM_420_470 rev.1.1.0, CC1125EM_169 rev.1.1.0, CC1125EM-Cat1-868 ($f_{\text{xosc}} = 40$ MHz).

4.1 Absolute Maximum Ratings⁽¹⁾⁽²⁾

PARAMETER	MIN	MAX	UNIT	CONDITION
Supply voltage (VDD, AVDD_x)	-0.3	3.9	V	All supply pins must have the same voltage
Solder reflow temperature		260	°C	According to IPC/JEDEC J-STD-020
Input RF level		+10	dBm	
Voltage on any digital pin	-0.3	VDD+0.3	V	max 3.9
Voltage on analog pins (including DCPL pins)	-0.3	2.0	V	

- Stresses beyond those listed under absolute maximum ratings may cause permanent damage to the device. These are stress ratings only, and functional operation of the device at these or any other conditions beyond those indicated under general characteristics is not implied. Exposure to absolute-maximum-rated conditions for extended periods may affect device reliability.
- All voltage values are with respect to V_{SS} , unless otherwise noted.

4.2 Handling Ratings

		MIN	MAX	UNIT
T_{stg}	Storage temperature range	-40	125	°C
V_{ESD}	Electrostatic discharge (ESD) performance:	Human body model (HBM), per ANSI/ESDA/JEDEC JS001 ⁽¹⁾		kV
		Charged device model (CDM), per JESD22-C101 ⁽²⁾		V
		-500	500	All pins

- JEDEC document JEP155 states that 500-V HBM allows safe manufacturing with a standard ESD control process.
- JEDEC document JEP157 states that 250-V HBM allows safe manufacturing with a standard ESD control process.

4.3 Recommended Operating Conditions (General Characteristics)

PARAMETER	MIN	TYP	MAX	UNIT	CONDITION
Voltage supply range	2.0		3.6	V	All supply pins must have the same voltage
Voltage on digital inputs	0		VDD	V	
Temperature range	-40		85	°C	Ambient

4.4 Thermal Resistance Characteristics for RHB Package

	°C/W ⁽¹⁾	AIR FLOW (m/s) ⁽²⁾
$R\theta_{\text{JC}}$ Junction-to-case (top)	21.1	0.00
$R\theta_{\text{JB}}$ Junction-to-board	5.3	0.00
$R\theta_{\text{JA}}$ Junction-to-free air	31.3	0.00
Ψ_{sjT} Junction-to-package top	0.2	0.00
Ψ_{sjB} Junction-to-board	5.3	0.00
$R\theta_{\text{JC}}$ Junction-to-case (bottom)	0.8	0.00

- These values are based on a JEDEC-defined 2S2P system (with the exception of the Theta JC [$R\theta_{\text{JC}}$] value, which is based on a JEDEC-defined 1S0P system) and will change based on environment as well as application. For more information, see these EIA/JEDEC standards:
 - JESD51-2, *Integrated Circuits Thermal Test Method Environmental Conditions - Natural Convection (Still Air)*
 - JESD51-3, *Low Effective Thermal Conductivity Test Board for Leaded Surface Mount Packages*
 - JESD51-7, *High Effective Thermal Conductivity Test Board for Leaded Surface Mount Packages*
 - JESD51-9, *Test Boards for Area Array Surface Mount Package Thermal Measurements*
Power dissipation of 40 mW and an ambient temperature of 25°C is assumed.
- m/s = meters per second

4.5 RF Characteristics

PARAMETER	MIN	TYP	MAX	UNIT	CONDITION
Frequency bands	820		960	MHz	
	410		480	MHz	
	(273.3)		(320)	MHz	See SWRA398 for more information.
	164		192	MHz	
	(205)		(240)	MHz	Contact TI for more information about the use of these frequency bands.
(136.7)		(160)	MHz		
Frequency resolution		30		Hz	In 820–950 MHz band
		15		Hz	In 410–480 MHz band
		6		Hz	In 164–192 MHz band
Data rate	0		200	kbps	Packet mode
	0		100	kbps	Transparent mode
Data rate step size		1e-4		bps	

4.6 Regulatory Standards

PERFORMANCE MODE	Frequency Band	Suitable for compliance with	Comments
High-performance mode	820–960 MHz	ARIB T-108 ARIB T-96 ETSI EN 300 220 category 1 ETSI EN 54-25 FCC PART 101 FCC PART 24 SUBMASK D FCC PART 15.247 FCC PART 15.249 FCC PART 90 MASK G FCC PART 90 MASK J	Performance also suitable for systems targeting maximum allowed output power in the respective bands, using a range extender such as the CC1190 device
	410–480 MHz	ARIB T-67 ARIB RCR STD-30 ETSI EN 301 166 ETSI EN 300 113 ETSI EN 300 220 category 1 FCC PART 90 MASK D FCC PART 90 MASK E FCC PART 90 MASK G	Performance also suitable for systems targeting maximum allowed output power in the respective bands, using a range extender
	164–192 MHz	ETSI EN 300 220 category 1 ETSI EN 301 166 ETSI EN 300 113 FCC PART 90 MASK C FCC PART 90 MASK D FCC PART 90 MASK E	Performance also suitable for systems targeting maximum allowed output power in the respective bands, using a range extender
Low-power mode	820–960 MHz	ETSI EN 300 220 category 2 FCC PART 15.247 FCC PART 15.249	
	410–480 MHz	ETSI EN 300 220 category 2	
	164–192 MHz	ETSI EN 300 220 category 2	

4.7 Current Consumption, Static Modes

$T_A = 25^\circ\text{C}$, $V_{DD} = 3.0\text{ V}$, $f_{\text{xosc}} = 32\text{ MHz}$ if nothing else stated.

PARAMETER	MIN	TYP	MAX	UNIT	CONDITION
Power down with retention		0.12	1	μA	
		0.5		μA	Low-power RC oscillator running
XOFF mode		170		μA	Crystal oscillator / TCXO disabled
IDLE mode		1.3		mA	Clock running, system waiting with no radio activity

4.8 Current Consumption, Transmit Modes

4.8.1 950-MHz Band (High-Performance Mode)

$T_A = 25^\circ\text{C}$, $V_{DD} = 3.0\text{ V}$, $f_{\text{xosc}} = 32\text{ MHz}$ if nothing else stated

PARAMETER	MIN	TYP	MAX	UNIT	CONDITION
TX current consumption +10 dBm		37		mA	
TX current consumption 0 dBm		26		mA	

4.8.2 868-, 915-, and 920-MHz Bands (High-Performance Mode)

$T_A = 25^\circ\text{C}$, $V_{DD} = 3.0\text{ V}$, $f_{\text{xosc}} = 40\text{ MHz}$ if nothing else stated

PARAMETER	MIN	TYP	MAX	UNIT	CONDITION
TX current consumption +14 dBm		47		mA	
TX current consumption +10 dBm		38		mA	

4.8.3 434-MHz Band (High-Performance Mode)

$T_A = 25^\circ\text{C}$, $V_{DD} = 3.0\text{ V}$, $f_{\text{xosc}} = 40\text{ MHz}$ if nothing else stated

PARAMETER	MIN	TYP	MAX	UNIT	CONDITION
TX current consumption +15 dBm		51		mA	
TX current consumption +14 dBm		47		mA	
TX current consumption +10 dBm		36		mA	

4.8.4 169-MHz Band (High Performance Mode)

$T_A = 25^\circ\text{C}$, $V_{DD} = 3.0\text{ V}$, $f_{\text{xosc}} = 40\text{ MHz}$ if nothing else stated

PARAMETER	MIN	TYP	MAX	UNIT	CONDITION
TX current consumption +15 dBm		56		mA	
TX current consumption +14 dBm		52		mA	
TX current consumption +10 dBm		40		mA	

4.8.5 Low-Power Mode

$T_A = 25^\circ\text{C}$, $V_{DD} = 3.0\text{ V}$, $f_c = 869.5\text{ MHz}$, $f_{\text{xosc}} = 32\text{ MHz}$ if nothing else stated

PARAMETER	MIN	TYP	MAX	UNIT	CONDITION
TX current consumption +10 dBm		32		mA	

4.9 Current Consumption, Receive Modes

4.9.1 High-Performance Mode

$T_A = 25^\circ\text{C}$, $V_{DD} = 3.0\text{ V}$, $f_c = 869.5\text{ MHz}$, $f_{xosc} = 32\text{ MHz}$ if nothing else stated

PARAMETER	MIN	TYP	MAX	UNIT	CONDITION
RX wait for sync 1.2 kbps, 4-byte preamble 38.4 kbps, 4-byte preamble		2 13.4		mA mA	Using RX sniff mode, where the receiver wakes up at regular intervals to look for an incoming packet
RX peak current, $f_{xosc} = 40\text{ MHz}$ 433-, 868-, 915-, and 920-MHz bands 169-MHz band		26 27		mA mA	Peak current consumption during packet reception at the sensitivity threshold
Average current consumption Check for data packet every 1 second using wake on radio		15		μA	50 kbps, 5-byte preamble, 40-kHz RC oscillator used as sleep timer

4.9.2 Low-Power Mode

$T_A = 25^\circ\text{C}$, $V_{DD} = 3.0\text{ V}$, $f_c = 869.5\text{ MHz}$, $f_{xosc} = 32\text{ MHz}$ if nothing else stated

PARAMETER	MIN	TYP	MAX	UNIT	CONDITION
RX peak current low-power RX mode 1.2 kbps		17		mA	Peak current consumption during packet reception at the sensitivity level

4.10 Receive Parameters

All RX measurements made at the antenna connector, to a bit error rate (BER) limit of 1%.

4.10.1 General Receive Parameters (High-Performance Mode)

$T_A = 25^\circ\text{C}$, $V_{DD} = 3.0\text{ V}$, $f_c = 869.5\text{ MHz}$ if nothing else stated

PARAMETER	MIN	TYP	MAX	UNIT	CONDITION
Saturation		+10		dBm	
Digital channel filter programmable bandwidth					
$f_{\text{xosc}} = 32\text{ MHz}$	2.8		200	kHz	
$f_{\text{xosc}} = 40\text{ MHz}$	3.5		250	kHz	
IIP3, normal mode		-14		dBm	At maximum gain
IIP3, high linearity mode		-8		dBm	Using 6-dB gain reduction in front end
Datarate offset tolerance		± 12		%	With carrier sense detection enabled and assuming 4-byte preamble
		± 0.2		%	With carrier sense detection disabled
Spurious emissions					
1–13 GHz (VCO leakage at 3.5 GHz)		-56		dBm	Radiated emissions measured according to ETSI EN 300 220, $f_c = 869.5\text{ MHz}$
30 MHz to 1 GHz		< -57		dBm	
Optimum source impedance					(Differential or single-ended RX configurations)
868-, 915-, and 920-MHz bands		$60 + j60 / 30 + j30$		Ω	
433-MHz band		$100 + j60 / 50 + j30$		Ω	
169-MHz band		$140 + j40 / 70 + j20$		Ω	

4.10.2 RX Performance in 950-MHz Band (High-Performance Mode)

$T_A = 25^\circ\text{C}$, $V_{DD} = 3.0\text{ V}$, $f_{xosc} = 32\text{ MHz}$ if nothing else stated

PARAMETER	MIN	TYP	MAX	UNIT	CONDITION
Sensitivity Note: Sensitivity can be improved if the TX and RX matching networks are separated.		-120		dBm	1.2 kbps, DEV=4 kHz CHF=10 kHz ⁽¹⁾
		-107		dBm	50 kbps 2GFSK, DEV=25 kHz, CHF=100 kHz
		-100		dBm	200 kbps, DEV=83 kHz (outer symbols), CHF=200 kHz, 4GFSK ⁽²⁾
Blocking and Selectivity 1.2 kbps 2-FSK, 12.5-kHz channel separation, 4-kHz deviation, 10-kHz channel filter		51		dB	$\pm 12.5\text{ kHz}$ (adjacent channel)
		52		dB	$\pm 25\text{ kHz}$ (alternate channel)
		73		dB	$\pm 1\text{ MHz}$
		76		dB	$\pm 2\text{ MHz}$
		81		dB	$\pm 10\text{ MHz}$
Blocking and Selectivity 50 kbps 2-GFSK, 200-kHz channel separation, 25-kHz deviation, 100-kHz channel filter (Same modulation format as 802.15.4g Mandatory Mode)		43		dB	$\pm 200\text{ kHz}$ (adjacent channel)
		51		dB	$\pm 400\text{ kHz}$ (alternate channel)
		62		dB	$\pm 1\text{ MHz}$
		65		dB	$\pm 2\text{ MHz}$
		71		dB	$\pm 10\text{ MHz}$
Blocking and Selectivity 200 kbps 4-GFSK, 83-kHz deviation (outer symbols), 200-kHz channel filter, zero IF		37		dB	$\pm 200\text{ kHz}$ (adjacent channel)
		44		dB	$\pm 400\text{ kHz}$ (alternate channel)
		55		dB	$\pm 1\text{ MHz}$
		58		dB	$\pm 2\text{ MHz}$
		64		dB	$\pm 10\text{ MHz}$

(1) DEV is short for deviation, CHF is short for channel filter bandwidth

(2) BT=0.5 is used in all GFSK measurements

4.10.3 RX Performance in 868-, 915-, and 920-MHz Bands (High-Performance Mode)

 $T_A = 25^\circ\text{C}$, $V_{DD} = 3.0\text{ V}$, $f_{xosc} = 32\text{ MHz}$ if nothing else stated if nothing else stated

PARAMETER	MIN	TYP	MAX	UNIT	CONDITION
Sensitivity		-129		dBm	300 bps, DEV=1 kHz CHF=3.8 kHz ⁽¹⁾ , $f_{xosc} = 40\text{ MHz}$
		-123		dBm	1.2 kbps, DEV=20 kHz CHF=50 kHz
		-114		dBm	4.8 kbps OOK
		-110		dBm	38.4 kbps, DEV=20 kHz CHF=100 kHz
		-110		dBm	50 kbps 2GFSK, DEV=25 kHz, CHF=100 kHz
Blocking and Selectivity 0.3-kbps 2-FSK, 6.25-kHz channel separation, 1-kHz deviation, 3.8-kHz channel filter $f_{xosc} = 40\text{ MHz}$ using TCXO		62		dB	$\pm 6.25\text{ kHz}$ (adjacent channel)
		63		dB	$\pm 12.5\text{ kHz}$ (alternate channel)
		83		dB	$\pm 1\text{ MHz}$
		87		dB	$\pm 2\text{ MHz}$
		91		dB	$\pm 10\text{ MHz}$
Blocking and Selectivity 1.2-kbps 2-FSK, 12.5-kHz channel separation, 4-kHz deviation, 10-kHz channel filter $f_{xosc} = 40\text{ MHz}$ using TCXO		58		dB	+ 12.5 kHz (adjacent channel)
		58		dB	$\pm 25\text{ kHz}$ (alternate channel)
		78		dB	$\pm 1\text{ MHz}$
		82		dB	$\pm 2\text{ MHz}$
		86		dB	$\pm 10\text{ MHz}$
Blocking and Selectivity 1.2-kbps 2-GFSK, 25-kHz channel separation, 4-kHz deviation, 16-kHz channel filter $f_{xosc} = 40\text{ MHz}$ using TCXO Using external SAW filter for compliance with ETSI category 1		58		dB	$\pm 25\text{ kHz}$ (alternate channel)
		77		dB	$\pm 1\text{ MHz}$
		106		dB	$\pm 2\text{ MHz}$
		101		dB	$\pm 10\text{ MHz}$
		42		dB	$\pm 100\text{ kHz}$ (adjacent channel)
Blocking and Selectivity 38.4-kbps 2-GFSK, 100-kHz channel separation, 20-kHz deviation, 100- kHz channel filter		43		dB	$\pm 200\text{ kHz}$ (alternate channel)
		62		dB	$\pm 1\text{ MHz}$
		66		dB	$\pm 2\text{ MHz}$
		74		dB	$\pm 10\text{ MHz}$
		43		dB	$\pm 200\text{ kHz}$ (adjacent channel)
Blocking and Selectivity 50-kbps 2-GFSK, 200-kHz channel separation, 25-kHz deviation, 100- kHz channel filter (Same modulation format as 802.15.4g Mandatory Mode)		50		dB	$\pm 400\text{ kHz}$ (alternate channel)
		61		dB	$\pm 1\text{ MHz}$
		65		dB	$\pm 2\text{ MHz}$
		74		dB	$\pm 10\text{ MHz}$
		36		dB	$\pm 200\text{ kHz}$ (adjacent channel)
Blocking and Selectivity 200-kbps 4-GFSK, 83-kHz deviation (outer symbols), 200-kHz channel filter, zero IF		44		dB	$\pm 400\text{ kHz}$ (alternate channel)
		55		dB	$\pm 1\text{ MHz}$
		59		dB	$\pm 2\text{ MHz}$
		67		dB	$\pm 10\text{ MHz}$
	Image rejection (Image compensation enabled) $f_{xosc} = 40\text{ MHz}$ using TCXO		58		dB

(1) DEV is short for deviation, CHF is short for channel filter bandwidth

4.10.4 RX Performance in 434-MHz Band (High-Performance Mode)

$T_A = 25^\circ\text{C}$, $V_{DD} = 3.0\text{ V}$, $f_{\text{xosc}} = 32\text{ MHz}$ if nothing else stated if nothing else stated

PARAMETER	MIN	TYP	MAX	UNIT	CONDITION
Sensitivity		-129		dBm	300 bps, DEV=1 kHz, CHF=3.8 kHz ⁽¹⁾ $f_{\text{xosc}} = 40\text{ MHz}$
		-123		dBm	1.2 kbps, DEV=4 kHz CHF=10 kHz ⁽¹⁾
		-109		dBm	50-kbps 2-GFSK, DEV=25 kHz, CHF=100 kHz ⁽¹⁾
		-116		dBm	1.2 kbps, DEV=20 kHz CHF=50 kHz ⁽¹⁾
Blocking and Selectivity 0.3-kbps 2-FSK, 6.25-kHz channel separation, 1-kHz deviation, 3.8-kHz channel filter $f_{\text{xosc}} = 40\text{ MHz}$ using TCXO		65		dB	+ 6.25 kHz (adjacent channel)
		66		dB	+ 12.5 kHz (alternate channel)
		86		dB	$\pm 1\text{ MHz}$
		90		dB	$\pm 2\text{ MHz}$
		95		dB	$\pm 10\text{ MHz}$
Blocking and Selectivity 1.2-kbps 2-FSK, 12.5-kHz channel separation, 4-kHz deviation, 10-kHz channel filter $f_{\text{xosc}} = 40\text{ MHz}$ using TCXO		60		dB	+ 12.5 kHz (adjacent channel)
		61		dB	$\pm 25\text{ kHz}$ (alternate channel)
		80		dB	$\pm 1\text{ MHz}$
		85		dB	$\pm 2\text{ MHz}$
		91		dB	$\pm 10\text{ MHz}$
Blocking and Selectivity 38.4-kbps 2-GFSK, 100-kHz channel separation, 20-kHz deviation, 100-kHz channel filter		47		dB	+ 100 kHz (adjacent channel)
		50		dB	$\pm 200\text{ kHz}$ (alternate channel)
		67		dB	$\pm 1\text{ MHz}$
		71		dB	$\pm 2\text{ MHz}$
		78		dB	$\pm 10\text{ MHz}$

(1) DEV is short for deviation, CHF is short for channel filter bandwidth

4.10.5 RX Performance in 169-MHz Band (High-Performance Mode)

$T_A = 25^\circ\text{C}$, $V_{DD} = 3.0\text{ V}$, $f_{\text{xosc}} = 32\text{ MHz}$ if nothing else stated

PARAMETER	MIN	TYP	MAX	UNIT	CONDITION
Sensitivity		-129		dBm	300 bps, DEV=1 kHz, CHF=3.8 kHz ⁽¹⁾ $f_{\text{xosc}} = 40\text{ MHz}$
		-123		dBm	1.2 kbps, DEV=4 kHz CHF=10 kHz ⁽¹⁾
Blocking and Selectivity 0.3-kbps 2-FSK, 6.25-kHz channel separation, 1-kHz deviation, 3.8-kHz channel filter $f_{\text{xosc}} = 40\text{ MHz}$ using TCXO		67		dB	$\pm 6.25\text{ kHz}$ (adjacent channel)
		67		dB	+ 12.5 kHz (alternate channel)
		88		dB	$\pm 1\text{ MHz}$
		101		dB	-2 MHz
		104		dB	$\pm 10\text{ MHz}$
Blocking and Selectivity 1.2-kbps 2-FSK, 12.5-kHz channel separation, 4-kHz deviation, 10-kHz channel filter $f_{\text{xosc}} = 40\text{ MHz}$ using TCXO		63		dB	$\pm 12.5\text{ kHz}$ (adjacent channel)
		65		dB	$\pm 25\text{ kHz}$ (alternate channel)
		82		dB	$\pm 1\text{ MHz}$
		86		dB	$\pm 2\text{ MHz}$
		93		dB	-10 MHz
Spurious Response Rejection 1.2-kbps 2-FSK, 12.5-kHz channel separation, 4-kHz deviation, 10-kHz channel filter		70		dB	
Image Rejection (Image compensation enabled)		66		dB	1.2 kbps, DEV=4 kHz CHF=10 kHz ⁽¹⁾ , image at -125 kHz

(1) DEV is short for deviation, CHF is short for channel filter bandwidth

4.10.6 RX Performance in Low-Power Mode

$T_A = 25^\circ\text{C}$, $V_{DD} = 3.0\text{ V}$, $f_c = 869.5\text{ MHz}$, $f_{xosc} = 32\text{ MHz}$ if nothing else stated

PARAMETER	MIN	TYP	MAX	UNIT	CONDITION
Sensitivity		-111		dBm	1.2 kbps, DEV=4 kHz CHF=10 kHz ⁽¹⁾
		-99		dBm	38.4 kbps, DEV=50 kHz CHF=100 kHz ⁽¹⁾
		-99		dBm	50-kbps 2-GFSK, DEV=25 kHz, CHF=100 kHz ⁽¹⁾
Blocking and Selectivity 1.2-kbps 2-FSK, 12.5-kHz channel separation, 4-kHz deviation, 10-kHz channel filter		46		dB	± 12.5 kHz (adjacent channel)
		46		dB	± 25 kHz (alternate channel)
		73		dB	± 1 MHz
		78		dB	± 2 MHz
		79		dB	± 10 MHz
Blocking and Selectivity 1.2-kbps 2-FSK, 50-kHz channel separation, 20-kHz deviation, 50-kHz channel filter		43		dB	± 50 kHz (adjacent channel)
		45		dB	+ 100 kHz (alternate channel)
		71		dB	± 1 MHz
		74		dB	± 2 MHz
		75		dB	± 10 MHz
Blocking and Selectivity 38.4-kbps 2-GFSK, 100-kHz channel separation, 20-kHz deviation, 100-kHz channel filter		37		dB	+ 100 kHz (adjacent channel)
		43		dB	+ 200 kHz (alternate channel)
		58		dB	± 1 MHz
		62		dB	± 2 MHz
		64		dB	+ 10 MHz
Blocking and Selectivity 50-kbps 2-GFSK, 200-kHz channel separation, 25-kHz deviation, 100-kHz channel filter (Same modulation format as 802.15.4g Mandatory Mode)		43		dB	+ 200 kHz (adjacent channel)
		52		dB	+ 400 kHz (alternate channel)
		60		dB	± 1 MHz
		64		dB	± 2 MHz
		65		dB	± 10 MHz
Saturation		+10		dBm	

(1) DEV is short for deviation, CHF is short for channel filter bandwidth

4.11 Transmit Parameters

 $T_A = 25^\circ\text{C}$, $V_{DD} = 3.0\text{ V}$, $f_c = 869.5\text{ MHz}$, $f_{\text{xosc}} = 32\text{ MHz}$ if nothing else stated

PARAMETER	MIN	TYP	MAX	UNIT	CONDITION
Max output power		+12		dBm	At 950 MHz
		+14		dBm	At 915- and 920-MHz
		+15		dBm	At 915- and 920-MHz with $V_{DD} = 3.6\text{ V}$
		+15		dBm	At 868 MHz
		+16		dBm	At 868 MHz with $V_{DD} = 3.6\text{ V}$
		+15		dBm	At 433 MHz
Min output power		-11		dBm	Within fine step size range
		-40		dBm	Within coarse step size range
Output power step size		0.4		dB	Within fine step size range
Adjacent channel power		-75		dBc	4-GFSK 9.6 kbps in 12.5-kHz channel, measured in 100-Hz bandwidth at 434 MHz (FCC Part 90 Mask D compliant)
		-58		dBc	4-GFSK 9.6 kbps in 12.5-kHz channel, measured in 8.75-kHz bandwidth (ETSI 300 220 compliant)
		-61		dBc	2-GFSK 2.4 kbps in 12.5-kHz channel, 1.2-kHz deviation
Spurious emissions (not including harmonics)		<-60		dBm	
Harmonics					Transmission at +14 dBm (or maximum allowed in applicable band where this is less than +14 dBm) using TI reference design. Emissions measured according to ARIB T-96 in 950-MHz band, ETSI EN 300-220 in 169-, 433-, and 868-MHz bands and FCC part 15.247 in 450- and 915-MHz band. Fourth harmonic in 915-MHz band will require extra filtering to meet FCC requirements if transmitting for long intervals (>50-ms periods).
Second Harm, 169 MHz		-39		dBm	
Third Harm, 169 MHz		-58		dBm	
Second Harm, 433 MHz		-56		dBm	
Third Harm, 433 MHz		-51		dBm	
Second Harm, 450 MHz		-60		dBm	
Third Harm, 450 MHz		-45		dBm	
Second Harm, 868 MHz		-40		dBm	
Third Harm, 868 MHz		-42		dBm	
Second Harm, 915 MHz		56		dBuV/m	
Third Harm, 915 MHz		52		dBuV/m	
Fourth Harm, 915 MHz		60		dBuV/m	
Second Harm, 950 MHz		-58		dBm	
Third Harm, 950 MHz		-42		dBm	
Optimum load					
Impedance 868-, 915-, and 920-MHz bands		35 + j35		Ω	
433-MHz band		55 + j25		Ω	
169-MHz band		80 + j0		Ω	

4.12 PLL Parameters

4.12.1 High-Performance Mode

$T_A = 25^\circ\text{C}$, $V_{DD} = 3.0\text{ V}$, $f_c = 869.5\text{ MHz}$, $f_{xosc} = 40\text{ MHz}$ using TCXO if nothing else stated

PARAMETER	MIN	TYP	MAX	UNIT	CONDITION
Phase noise in 950-MHz band $f_{xosc} = 32\text{ MHz}$		-100		dBc/Hz	$\pm 10\text{ kHz offset}$
		-103		dBc/Hz	$\pm 100\text{ kHz offset}$
		-123		dBc/Hz	$\pm 1\text{ MHz offset}$
Phase noise in 868-, 915-, 920-MHz bands		-101		dBc/Hz	$\pm 10\text{ kHz offset}$
		-102		dBc/Hz	$\pm 100\text{ kHz offset}$
		-124		dBc/Hz	$\pm 1\text{ MHz offset}$
Phase noise in 433-MHz band		-107		dBc/Hz	$\pm 10\text{ kHz offset}$
		-110		dBc/Hz	$\pm 100\text{ kHz offset}$
		-130		dBc/Hz	$\pm 1\text{ MHz offset}$
Phase noise in 169-MHz band		-115		dBc/Hz	$\pm 10\text{ kHz offset}$
		-115		dBc/Hz	$\pm 100\text{ kHz offset}$
		-135		dBc/Hz	$\pm 1\text{ MHz offset}$

4.12.2 Low-Power Mode

$T_A = 25^\circ\text{C}$, $V_{DD} = 3.0\text{ V}$, $f_c = 869.5\text{ MHz}$, $f_{xosc} = 32\text{ MHz}$ if nothing else stated

PARAMETER	MIN	TYP	MAX	UNIT	CONDITION
Phase noise in 950-MHz band		-90		dBc/Hz	$\pm 10\text{ kHz offset}$
		-92		dBc/Hz	$\pm 100\text{ kHz offset}$
		-124		dBc/Hz	$\pm 1\text{ MHz offset}$
Phase noise in 868-, 915-, and 920-MHz bands		-95		dBc/Hz	$\pm 10\text{ kHz offset}$
		-95		dBc/Hz	$\pm 100\text{ kHz offset}$
		-124		dBc/Hz	$\pm 1\text{ MHz offset}$
Phase noise in 433-MHz band		-98		dBc/Hz	$\pm 10\text{ kHz offset}$
		-102		dBc/Hz	$\pm 100\text{ kHz offset}$
		-129		dBc/Hz	$\pm 1\text{ MHz offset}$
Phase noise in 169-MHz band		-106		dBc/Hz	$\pm 10\text{ kHz offset}$
		-110		dBc/Hz	$\pm 100\text{ kHz offset}$
		-136		dBc/Hz	$\pm 1\text{ MHz offset}$

4.13 Wake-up and Timing

 $T_A = 25^\circ\text{C}$, $V_{DD} = 3.0\text{ V}$, $f_c = 869.5\text{ MHz}$, $f_{\text{XOSC}} = 32\text{ MHz}$ if nothing else stated

PARAMETER	MIN	TYP	MAX	UNIT	CONDITION
Powerdown to IDLE		0.4		ms	Depends on crystal
IDLE to RX/TX		166		μs	Calibration disabled
		461		μs	Calibration enabled
RX/TX turnaround		50		μs	
RX/TX to IDLE time		296		μs	Calibrate when leaving RX/TX enabled
		0		μs	Calibrate when leaving RX/TX disabled
Frequency synthesizer calibration		391		μs	When using SCAL strobe
Minimum required number of preamble bytes		0.5		bytes	Required for RF front-end gain settling only. Digital demodulation does not require preamble for settling.
Time from start RX until valid RSSI, including gain settling (function of channel bandwidth. Programmable for trade-off between speed and accuracy)		4.6		ms	12.5-kHz channels
		0.3		ms	200-kHz channels

4.14 High-Speed Crystal Oscillator

 $T_A = 25^\circ\text{C}$, $V_{DD} = 3.0\text{ V}$ if nothing else stated

PARAMETER	MIN	TYP	MAX	UNIT	CONDITION
Crystal frequency	32		44	MHz	It is expected that there will be degraded sensitivity at multiples of XOSC/2 in RX, and an increase in spurious emissions when the RF channel is close to multiples of XOSC in TX. We recommend that the RF channel is kept RX_BW/2 away from XOSC/2 in RX, and that the level of spurious emissions be evaluated if the RF channel is closer than 1 MHz to multiples of XOSC in TX.
Load capacitance (C_L)		10		pF	
ESR		<50		Ω	
Start-up time		0.4		ms	Depends on crystal

4.15 High-Speed Clock Input (TCXO)

 $T_A = 25^\circ\text{C}$, $V_{DD} = 3.0\text{ V}$ if nothing else stated

PARAMETER	MIN	TYP	MAX	UNIT	CONDITION
Clock frequency	32		44	MHz	
TCXO with CMOS output					TCXO with CMOS output directly coupled to pin EXT_OSC
High input voltage	1.4		VDD	V	
Low input voltage	0		0.6	V	
Rise / Fall time			2	ns	
Clipped sine output					TCXO clipped sine output connected to pin EXT_OSC through series capacitor
Clock input amplitude (peak-to-peak)	0.8		1.5	V	

4.16 32-kHz Clock Input

 $T_A = 25^\circ\text{C}$, $V_{DD} = 3.0\text{ V}$ if nothing else stated

PARAMETER	MIN	TYP	MAX	UNIT	CONDITION
Clock frequency		32		kHz	
32-kHz clock input pin input high voltage	0.8xVDD			V	
32-kHz clock input pin input low voltage			0.2xVDD	V	

4.17 Low Speed RC Oscillator

$T_A = 25^\circ\text{C}$, $V_{DD} = 3.0\text{ V}$ if nothing else stated

PARAMETER	MIN	TYP	MAX	UNIT	CONDITION
Frequency		32/40		kHz	After calibration (calibrated against the high-speed XOSC)
Frequency accuracy after calibration		± 0.1		%	Relative to frequency reference (for example, 32-MHz crystal or TCXO)
Initial calibration time		1.6		ms	

4.18 I/O and Reset

$T_A = 25^\circ\text{C}$, $V_{DD} = 3.0\text{ V}$ if nothing else stated

PARAMETER	MIN	TYP	MAX	UNIT	CONDITION
Logic input high voltage	$0.8 \times V_{DD}$			V	
Logic input low voltage			$0.2 \times V_{DD}$	V	
Logic output high voltage	$0.8 \times V_{DD}$			V	At 4-mA output load or less
Logic output low voltage			$0.2 \times V_{DD}$	V	
Power-on reset threshold		1.3		V	Voltage on DVDD pin

4.19 Temperature Sensor

$T_A = 25^\circ\text{C}$, $V_{DD} = 3.0\text{ V}$ if nothing else stated

PARAMETER	MIN	TYP	MAX	UNIT	CONDITION
Temperature sensor range	-40		85	$^\circ\text{C}$	
Temperature coefficient		2.66		$\text{mV} / ^\circ\text{C}$	Change in sensor output voltage versus change in temperature
Typical output voltage		794		mV	Typical sensor output voltage at $T_A = 25^\circ\text{C}$, $V_{DD} = 3.0\text{ V}$
VDD coefficient		1.17		mV / V	Change in sensor output voltage versus change in VDD

The CC1125 device can be configured to provide a voltage proportional to temperature on GPIO1. The temperature can be estimated by measuring this voltage (see [Section 4.19, Temperature Sensor](#)). For more information, see the temperature sensor design note ([SWRA415](#)).

4.20 Typical Characteristics

$T_A = 25^\circ\text{C}$, $V_{DD} = 3.0\text{ V}$, $f_c = 869.5\text{ MHz}$ if nothing else stated.

All measurements performed on CC1120EM_868_915 rev.1.0.1, CC1120EM_955 rev.1.2.1, CC1120EM_420_470 rev.1.0.1 or CC1120EM_169 rev.1.2 ($f_{\text{xosc}} = 32\text{ MHz}$), and CC1125EM_868_915 rev.1.1.0, CC1125EM_420_470 rev.1.1.0, CC1125EM_169 rev.1.1.0, CC1125EM-Cat1-868 ($f_{\text{xosc}} = 40\text{ MHz}$).

Figure 4-16 was measured at the 50- Ω antenna connector.

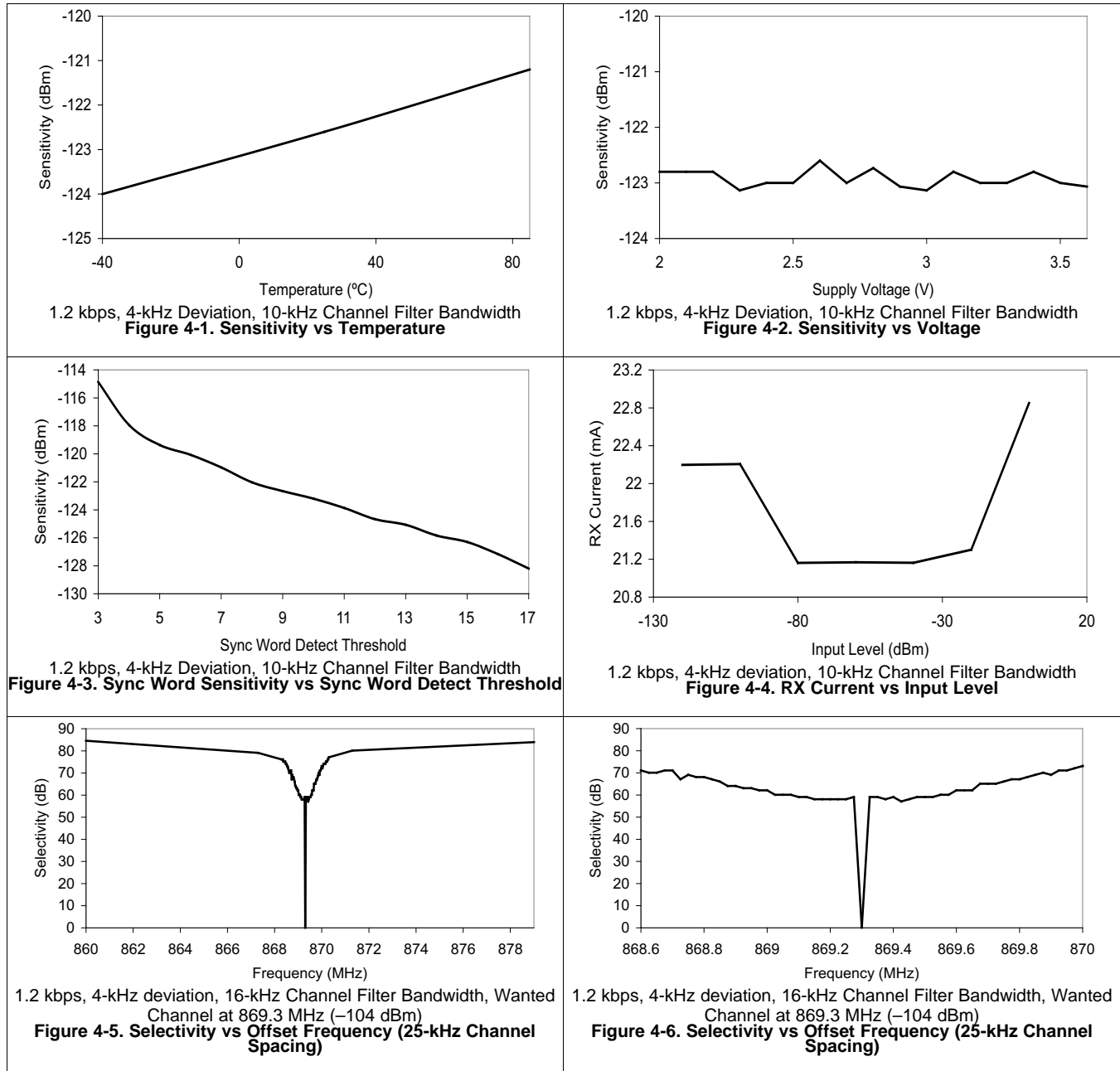

Typical Characteristics (continued)

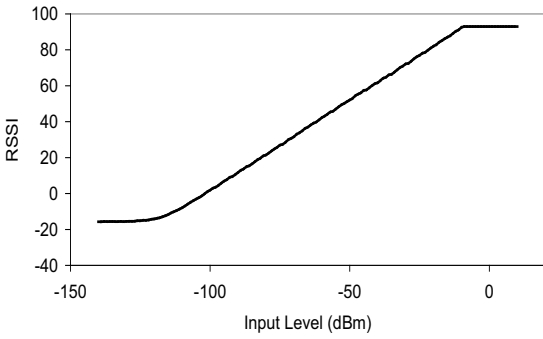

Figure 4-7. RSSI vs Input Level

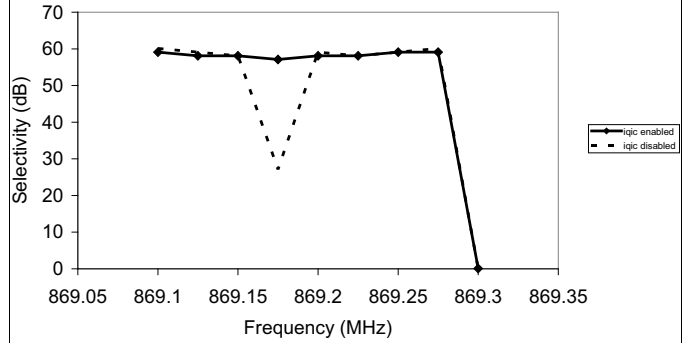

Figure 4-8. Automatic Image Cancellation

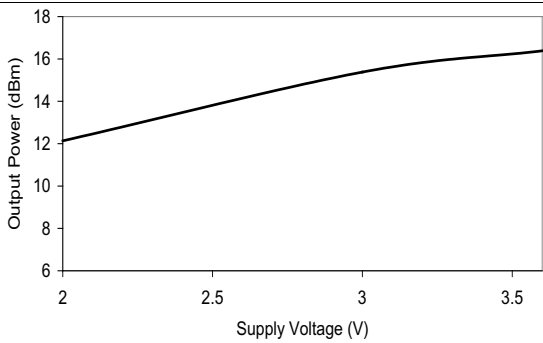

Figure 4-9. Output Power vs Voltage
Max Setting, 170 MHz

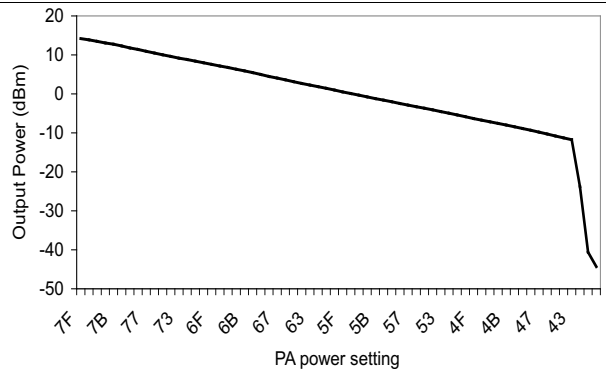

Figure 4-10. Output Power at 868 MHz
vs PA Power Setting

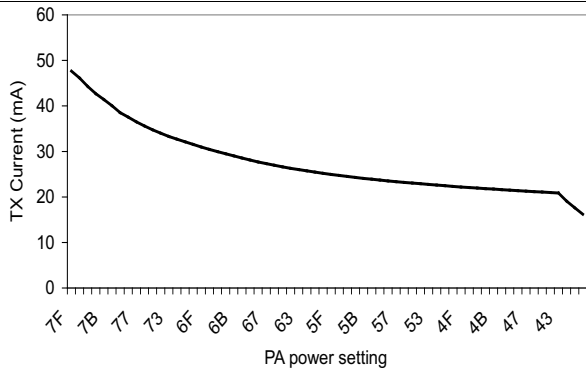

Figure 4-11. TX Current at 868 MHz
vs PA Power Setting

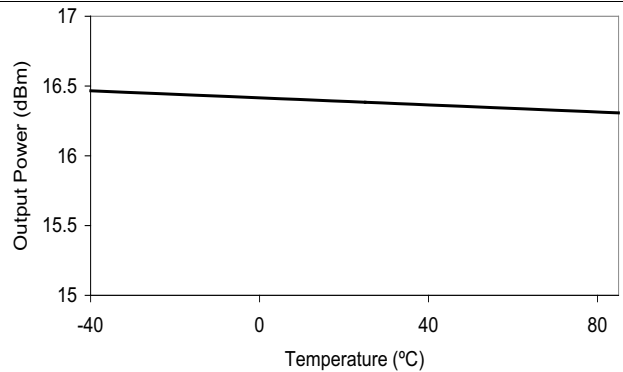
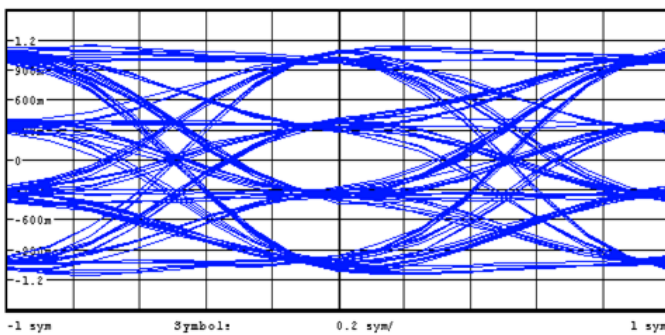
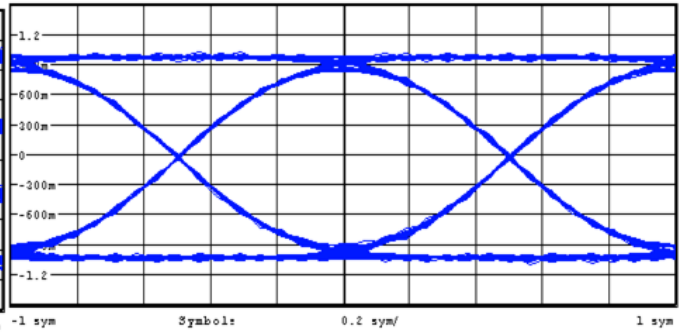

Figure 4-12. Output Power vs Temperature
Max Setting, 170 MHz, 3.6 V

Typical Characteristics (continued)



200 kbps, DEV = 83 kHz (Outer Symbols), 4GFSK
Figure 4-13. Eye Diagram



1.2 kbps 2-FSK, DEV = 4 kHz
Figure 4-14. Eye Diagram

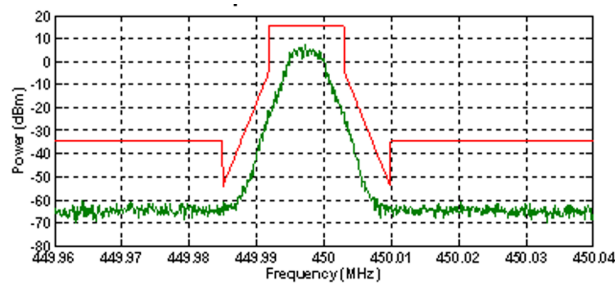

9.6 kbps in 12.5 kHz Channel
Figure 4-15. FCC Part 90 Mask D

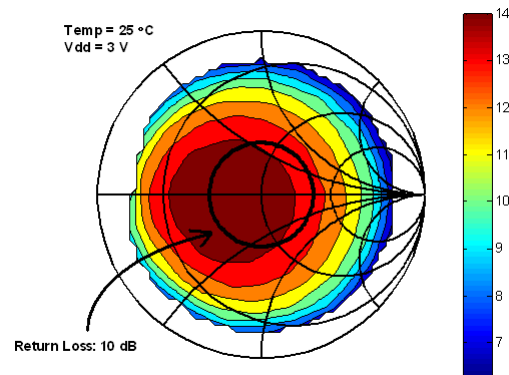

Figure 4-16. Output Power vs Load Impedance (+14-dBm Setting)

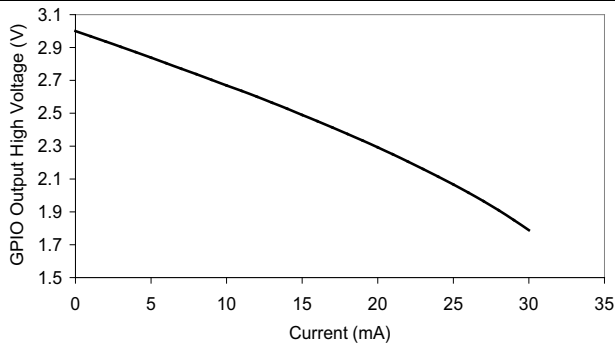

Figure 4-17. GPIO Output High Voltage vs Current Being Sourced

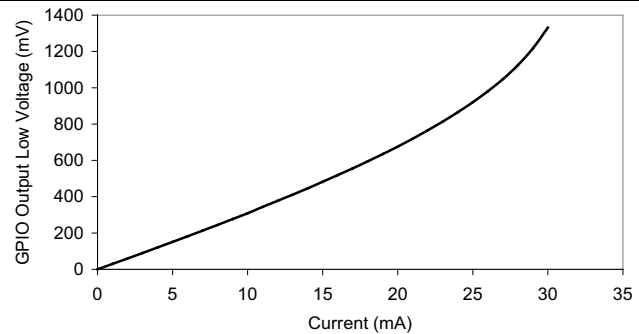

Figure 4-18. GPIO Output Low Voltage vs Current Being Sunk

5 Detailed Description

5.1 Block Diagram

Figure 5-1 shows the system block diagram of the CC1125 device.

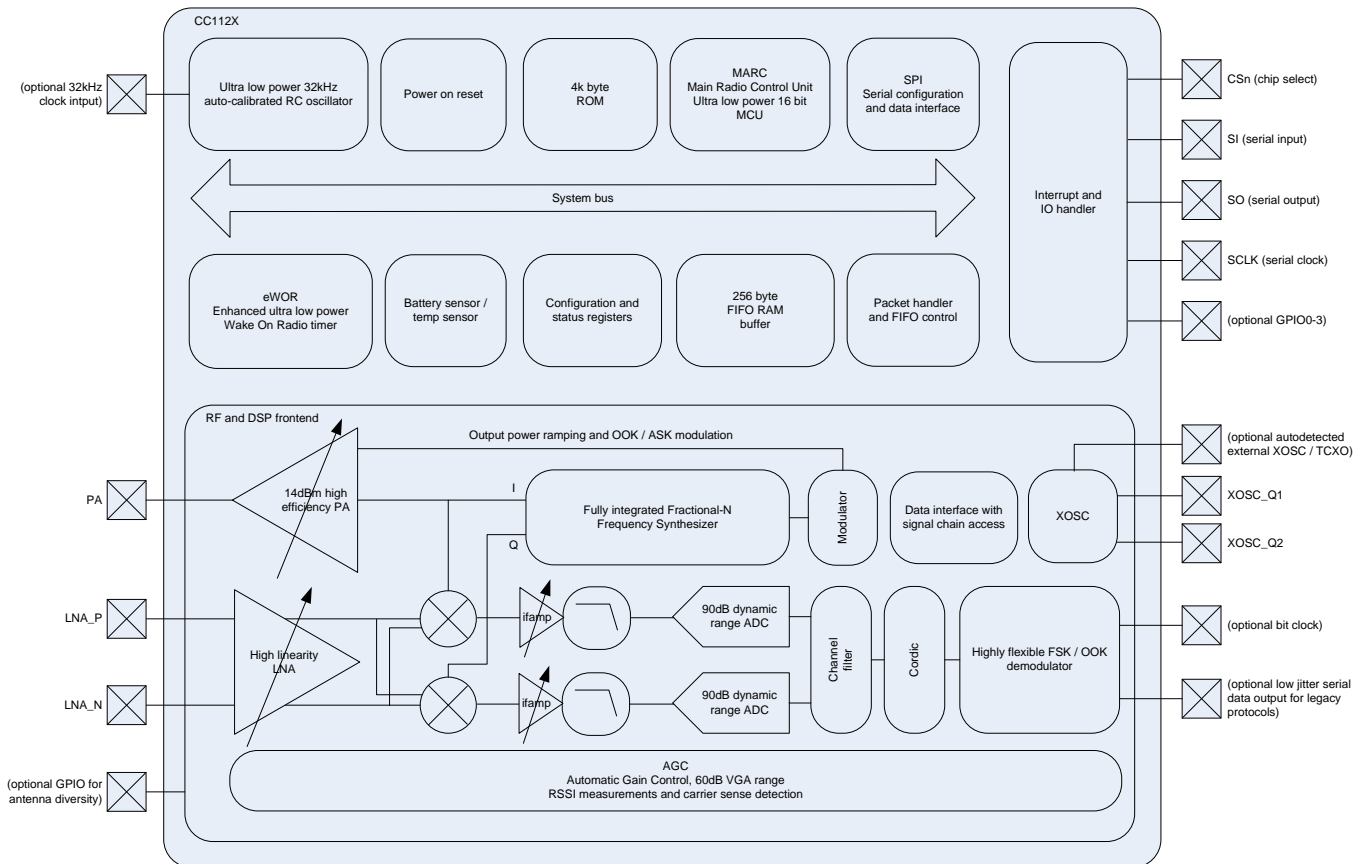

Figure 5-1. System Block Diagram

5.2 Frequency Synthesizer

At the center of the CC1125 device there is a fully integrated, fractional-N, ultra-high-performance frequency synthesizer. The frequency synthesizer is designed for excellent phase noise performance, providing very high selectivity and blocking performance. The system is designed to comply with the most stringent regulatory spectral masks at maximum transmit power.

Either a crystal can be connected to XOSC_Q1 and XOSC_Q2, or a TCXO can be connected to the EXT_XOSC input. The oscillator generates the reference frequency for the synthesizer, as well as clocks for the analog-to-digital converter (ADC) and the digital part. To reduce system cost, CC1125 device has high-accuracy frequency estimation and compensation registers to measure and compensate for crystal inaccuracies. This compensation enables the use of lower cost crystals. If a TCXO is used, the CC1125 device automatically turns on and off the TCXO when needed to support low-power modes and Wake-On-Radio operation.

5.3 Receiver

The CC1125 device features a highly flexible receiver. The received RF signal is amplified by the low-noise amplifier (LNA) and is down-converted in quadrature (I/Q) to the intermediate frequency (IF). At IF, the I/Q signals are digitized by the high dynamic-range ADCs.

An advanced automatic gain control (AGC) unit adjusts the front-end gain, and enables the CC1125 device to receive strong and weak signals, even in the presence of strong interferers. High-attenuation channels and data filtering enable reception with strong neighbor channel interferers. The I/Q signal is converted to a phase and magnitude signal to support the FSK and OOK modulation schemes.

NOTE

A unique I/Q compensation algorithm removes any problem of I/Q mismatch, thus avoiding time-consuming and costly I/Q image calibration steps.

5.4 Transmitter

The CC1125 transmitter is based on direct synthesis of the RF frequency (in-loop modulation). To use the spectrum effectively, the CC1125 device has extensive data filtering and shaping in TX mode to support high throughput data communication in narrowband channels. The modulator also controls power ramping to remove issues such as spectral splattering when driving external high-power RF amplifiers.

5.5 Radio Control and User Interface

The CC1125 digital control system is built around the main radio control (MARC), which is implemented using an internal high-performance, 16-bit ultra-low-power processor. MARC handles power modes, radio sequencing, and protocol timing.

A 4-wire SPI serial interface is used for configuration and data buffer access. The digital baseband includes support for channel configuration, packet handling, and data buffering. The host MCU can stay in power-down mode until a valid RF packet is received. This greatly reduces power consumption. When the host MCU receives a valid RF packet, it burst-reads the data. This reduces the required computing power.

The CC1125 radio control and user interface are based on the widely used CC1101 transceiver. This relationship enables an easy transition between the two platforms. The command strobes and the main radio states are the same for the two platforms.

For legacy formats, the CC1125 device also supports two serial modes.

- Synchronous serial mode: The CC1125 device performs bit synchronization and provides the MCU with a bit clock with associated data.
- Transparent mode: The CC1125 device outputs the digital baseband signal using a digital interpolation filter to eliminate jitter introduced by digital filtering and demodulation.

5.6 4.5 Enhanced Wake-On-Radio (eWOR)

eWOR, using a flexible integrated sleep timer, enables automatic receiver polling with no intervention from the MCU. When the CC1125 device enters RX mode, it listens and then returns to sleep if a valid RF packet is not received. The sleep interval and duty cycle can be configured to make a trade-off between network latency and power consumption. Incoming messages are time-stamped to simplify timer re-synchronization.

The eWOR timer runs off an ultra-low-power 32-kHz RC oscillator. To improve timing accuracy, the RC oscillator can be automatically calibrated to the RF crystal in configurable intervals.

5.7 Sniff Mode

The CC1125 device supports quick start up times, and requires few preamble bits. Sniff mode uses these conditions to dramatically reduce the current consumption while the receiver is waiting for data.

Because the CC1125 device can wake up and settle much faster than the duration of most preambles, it is not required to be in RX mode continuously while waiting for a packet to arrive. Instead, the enhanced Wake-On-Radio feature can be used to put the device into sleep mode periodically. By setting an appropriate sleep time, the CC1125 device can wake up and receive the packet when it arrives with no performance loss. This sequence removes the need for accurate timing synchronization between transmitter and receiver, and lets the user trade off current consumption between the transmitter and receiver.

For more information, see the sniff mode design note ([SWRA428](#)).

5.8 Antenna Diversity

Antenna diversity can increase performance in a multipath environment. An external antenna switch is required. The CC1201 device uses one of the GPIO pins to automatically control the switch. This device also supports differential output control signals typically used in RF switches.

If antenna diversity is enabled, the GPIO alternates between high and low states until a valid RF input signal is detected. An optional acknowledge packet can be transmitted without changing the state of the GPIO.

An incoming RF signal can be validated by received signal strength or by using the automatic preamble detector. Using the automatic preamble detector ensures a more robust system and avoids the need to set a defined signal strength threshold (such a threshold sets the sensitivity limit of the system).

5.9 WaveMatch

Advanced capture logic locks onto the synchronization word and does not require preamble settling bytes. Therefore, receiver settling time is reduced to the settling time of the AGC, typically 4 bits.

The WaveMatch feature also greatly reduces false sync triggering on noise, further reducing the power consumption and improving sensitivity and reliability. The same logic can also be used as a high-performance preamble detector to reliably detect a valid preamble in the channel.

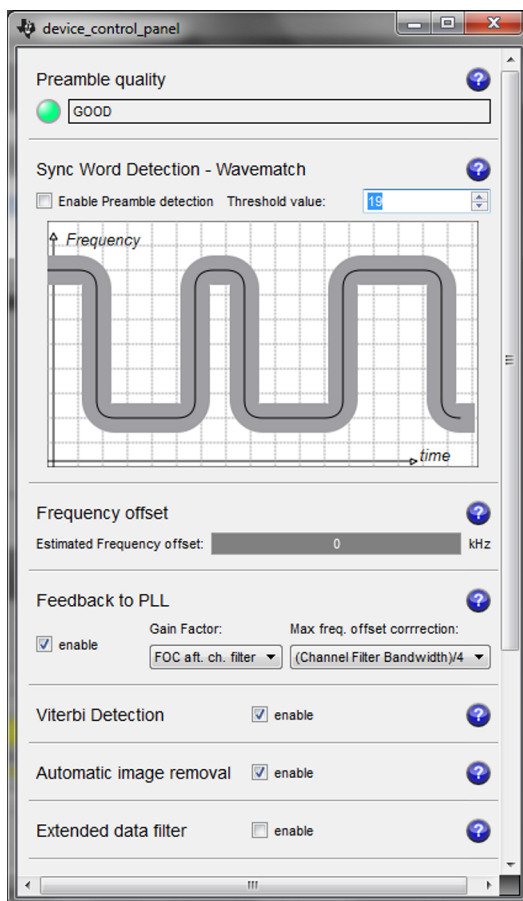

See [SWRC046](#) for more information.

Figure 5-2. Receiver Configurator in SmartRF™ Studio

6 Typical Application Circuit

NOTE

This section is intended only as an introduction.

Very few external components are required for the operation of the CC1125 device. [Figure 6-1](#) shows a typical application circuit. The board layout will greatly influence the RF performance of the CC1125 device. [Figure 6-1](#) does not show decoupling capacitors for power pins.

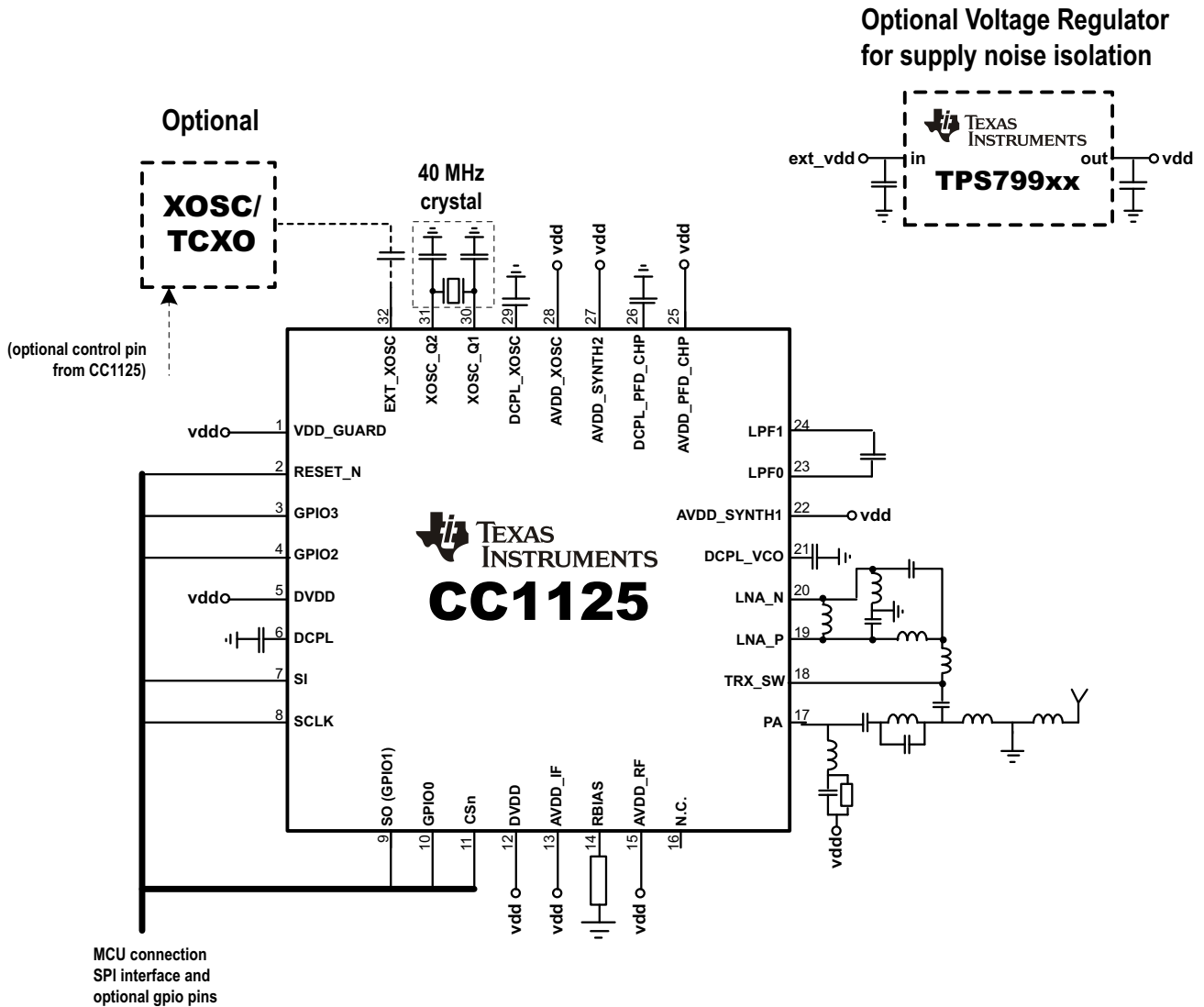

Figure 6-1. Typical Application Circuit

For more information, see the reference designs available for the CC1125 device in [Section 7.2, Documentation Support](#).

7 Device and Documentation Support

7.1 Device Support

7.1.1 Development Support

7.1.1.1 Configuration Software

The CC1125 device can be configured using the SmartRF Studio software ([SWRC046](#)). The SmartRF Studio software is highly recommended for obtaining optimum register settings, and for evaluating performance and functionality.

7.1.2 Device and Development-Support Tool Nomenclature

To designate the stages in the product development cycle, TI assigns prefixes to the part numbers of all microprocessors (MPUs) and support tools. Each device has one of three prefixes: X, P, or null (no prefix) (for example, CC1125). Texas Instruments recommends two of three possible prefix designators for its support tools: TMDX and TMDS. These prefixes represent evolutionary stages of product development from engineering prototypes (TMDX) through fully qualified production devices and tools (TMDS).

Device development evolutionary flow:

- X** Experimental device that is not necessarily representative of the final device's electrical specifications and may not use production assembly flow.
- P** Prototype device that is not necessarily the final silicon die and may not necessarily meet final electrical specifications.
- null** Production version of the silicon die that is fully qualified.

Support tool development evolutionary flow:

- TMDX** Development-support product that has not yet completed Texas Instruments internal qualification testing.
- TMDS** Fully qualified development-support product.

X and P devices and TMDX development-support tools are shipped against the following disclaimer:

"Developmental product is intended for internal evaluation purposes."

Production devices and TMDS development-support tools have been characterized fully, and the quality and reliability of the device have been demonstrated fully. TI's standard warranty applies.

Predictions show that prototype devices (X or P) have a greater failure rate than the standard production devices. Texas Instruments recommends that these devices not be used in any production system because their expected end-use failure rate still is undefined. Only qualified production devices are to be used.

TI device nomenclature also includes a suffix with the device family name. This suffix indicates the package type (for example, RHB), the temperature range (for example, blank is the default commercial temperature range), and the device speed range, in megahertz. provides a legend for reading the complete device name for any CC1125 device.

For orderable part numbers of CC1125 devices in the QFN package types, see the Package Option Addendum of this document, the TI website (www.ti.com), or contact your TI sales representative.

7.2 Documentation Support

The following documents supplement the CC1125 processor. Copies of these documents are available on the Internet at www.ti.com. *Tip:* Enter the literature number in the search box provided at www.ti.com.

- [SWRR106](#) CC112x IPC 868- and 915-MHz 2-layer Reference Design
- [SWRR107](#) CC112x IPC 868- and 915-MHz 4-layer Reference Design
- [SWRR100](#) CC1125EM 169-MHz Reference Design
- [SWRR101](#) CC1125EM 420- to 470-MHz Reference Design
- [SWRR102](#) CC1121EM 868- to 915-MHz Reference Design
- [SWRR097](#) CC1120EM CAT1 868-MHz Reference Design
- [SWRC046](#) SmartRF Studio Software
- [SWRA428](#) CC112x/CC120x Sniff Mode Application Note

7.3 Community Resources

The following links connect to TI community resources. Linked contents are provided "AS IS" by the respective contributors. They do not constitute TI specifications and do not necessarily reflect TI's views; see TI's [Terms of Use](#).

[TI E2E™ Online Community](#) *TI's Engineer-to-Engineer (E2E) Community*. Created to foster collaboration among engineers. At e2e.ti.com, you can ask questions, share knowledge, explore ideas and help solve problems with fellow engineers.

[TI Embedded Processors Wiki](#) *Texas Instruments Embedded Processors Wiki*. Established to help developers get started with Embedded Processors from Texas Instruments and to foster innovation and growth of general knowledge about the hardware and software surrounding these devices.

7.4 Trademarks

SmartRF, E2E are trademarks of Texas Instruments.

7.5 Electrostatic Discharge Caution



This integrated circuit can be damaged by ESD. Texas Instruments recommends that all integrated circuits be handled with appropriate precautions. Failure to observe proper handling and installation procedures can cause damage.

ESD damage can range from subtle performance degradation to complete device failure. Precision integrated circuits may be more susceptible to damage because very small parametric changes could cause the device not to meet its published specifications.

7.6 Glossary

[SLYZ022](#) — *TI Glossary*.

This glossary lists and explains terms, acronyms, and definitions.

8 Mechanical Packaging and Orderable Information

The following pages include mechanical packaging and orderable information. This information is the most current data available for the designated devices. This data is subject to change without notice and revision of this document. For browser-based versions of this data sheet, refer to the left-hand navigation.

PACKAGING INFORMATION

Orderable Device	Status (1)	Package Type	Package Drawing	Pins	Package Qty	Eco Plan (2)	Lead/Ball Finish (6)	MSL Peak Temp (3)	Op Temp (°C)	Device Marking (4/5)	Samples
CC1125RHBR	ACTIVE	VQFN	RHB	32	3000	Green (RoHS & no Sb/Br)	CU NIPDAU CU NIPDAUAG	Level-3-260C-168 HR	-40 to 85	CC1125	Samples
CC1125RHBT	ACTIVE	VQFN	RHB	32	250	Green (RoHS & no Sb/Br)	CU NIPDAU CU NIPDAUAG	Level-3-260C-168 HR	-40 to 85	CC1125	Samples

(1) The marketing status values are defined as follows:

ACTIVE: Product device recommended for new designs.

LIFEBUY: TI has announced that the device will be discontinued, and a lifetime-buy period is in effect.

NRND: Not recommended for new designs. Device is in production to support existing customers, but TI does not recommend using this part in a new design.

PREVIEW: Device has been announced but is not in production. Samples may or may not be available.

OBSOLETE: TI has discontinued the production of the device.

(2) **RoHS:** TI defines "RoHS" to mean semiconductor products that are compliant with the current EU RoHS requirements for all 10 RoHS substances, including the requirement that RoHS substance do not exceed 0.1% by weight in homogeneous materials. Where designed to be soldered at high temperatures, "RoHS" products are suitable for use in specified lead-free processes. TI may reference these types of products as "Pb-Free".

RoHS Exempt: TI defines "RoHS Exempt" to mean products that contain lead but are compliant with EU RoHS pursuant to a specific EU RoHS exemption.

Green: TI defines "Green" to mean the content of Chlorine (Cl) and Bromine (Br) based flame retardants meet JS709B low halogen requirements of <=1000ppm threshold. Antimony trioxide based flame retardants must also meet the <=1000ppm threshold requirement.

(3) MSL, Peak Temp. - The Moisture Sensitivity Level rating according to the JEDEC industry standard classifications, and peak solder temperature.

(4) There may be additional marking, which relates to the logo, the lot trace code information, or the environmental category on the device.

(5) Multiple Device Markings will be inside parentheses. Only one Device Marking contained in parentheses and separated by a "~" will appear on a device. If a line is indented then it is a continuation of the previous line and the two combined represent the entire Device Marking for that device.

(6) Lead/Ball Finish - Orderable Devices may have multiple material finish options. Finish options are separated by a vertical ruled line. Lead/Ball Finish values may wrap to two lines if the finish value exceeds the maximum column width.

Important Information and Disclaimer:The information provided on this page represents TI's knowledge and belief as of the date that it is provided. TI bases its knowledge and belief on information provided by third parties, and makes no representation or warranty as to the accuracy of such information. Efforts are underway to better integrate information from third parties. TI has taken and continues to take reasonable steps to provide representative and accurate information but may not have conducted destructive testing or chemical analysis on incoming materials and chemicals. TI and TI suppliers consider certain information to be proprietary, and thus CAS numbers and other limited information may not be available for release.

In no event shall TI's liability arising out of such information exceed the total purchase price of the TI part(s) at issue in this document sold by TI to Customer on an annual basis.

GENERIC PACKAGE VIEW

RHB 32

VQFN - 1 mm max height

5 x 5, 0.5 mm pitch

PLASTIC QUAD FLATPACK - NO LEAD



Images above are just a representation of the package family, actual package may vary.
Refer to the product data sheet for package details.

4224745/A

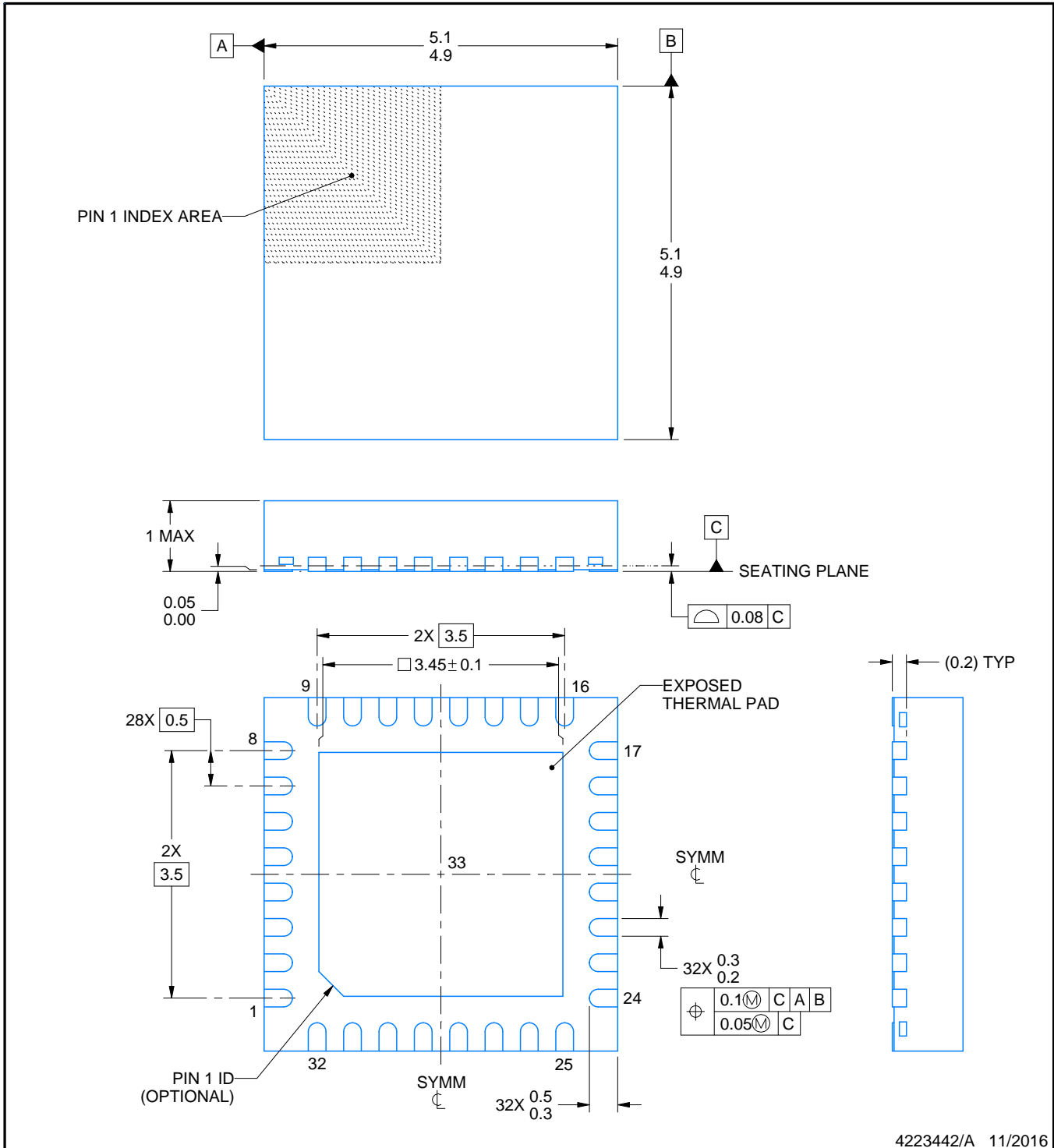

NOTES:

1. All linear dimensions are in millimeters. Any dimensions in parenthesis are for reference only. Dimensioning and tolerancing per ASME Y14.5M.
2. This drawing is subject to change without notice.
3. The package thermal pad must be soldered to the printed circuit board for thermal and mechanical performance.

EXAMPLE BOARD LAYOUT

RHB0032E

VQFN - 1 mm max height

PLASTIC QUAD FLATPACK - NO LEAD

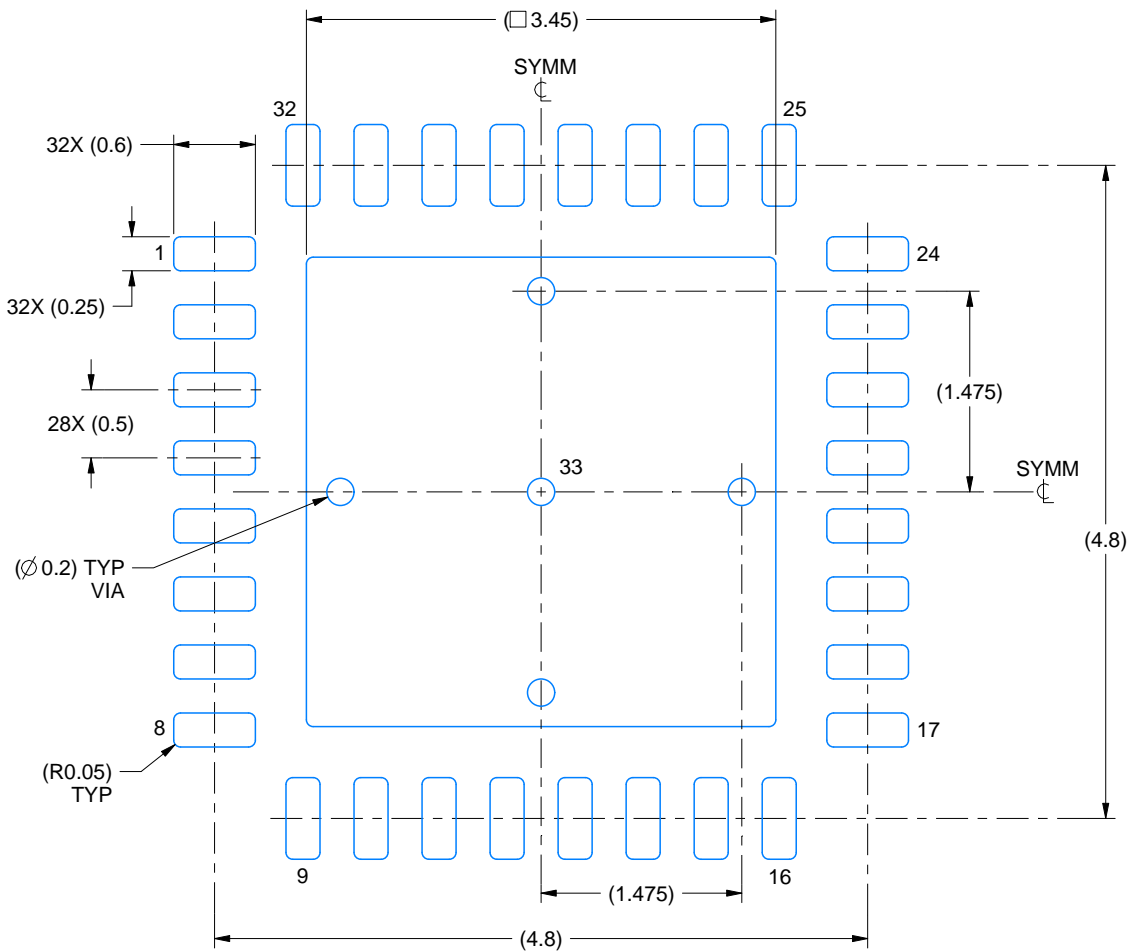

LAND PATTERN EXAMPLE
SCALE:18X

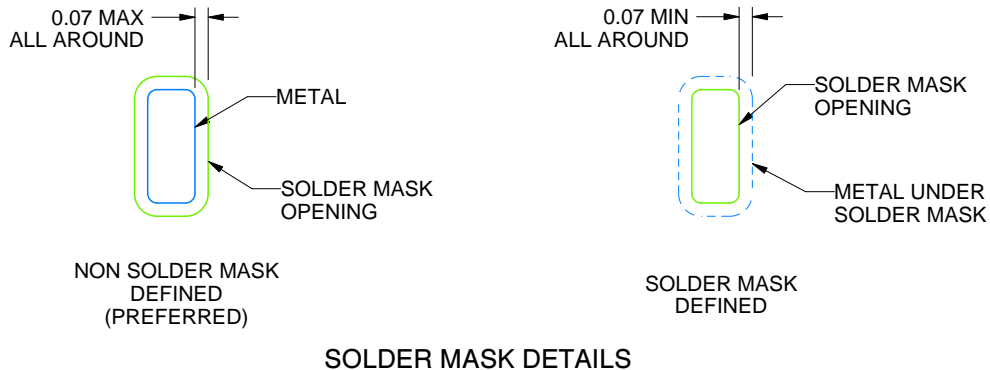

SOLDER MASK DETAILS

4223442/A 11/2016

NOTES: (continued)

4. This package is designed to be soldered to a thermal pad on the board. For more information, see Texas Instruments literature number SLUA271 (www.ti.com/lit/sl原因271).
5. Vias are optional depending on application, refer to device data sheet. If any vias are implemented, refer to their locations shown on this view. It is recommended that vias under paste be filled, plugged or tented.

EXAMPLE STENCIL DESIGN

RHB0032E

VQFN - 1 mm max height

PLASTIC QUAD FLATPACK - NO LEAD

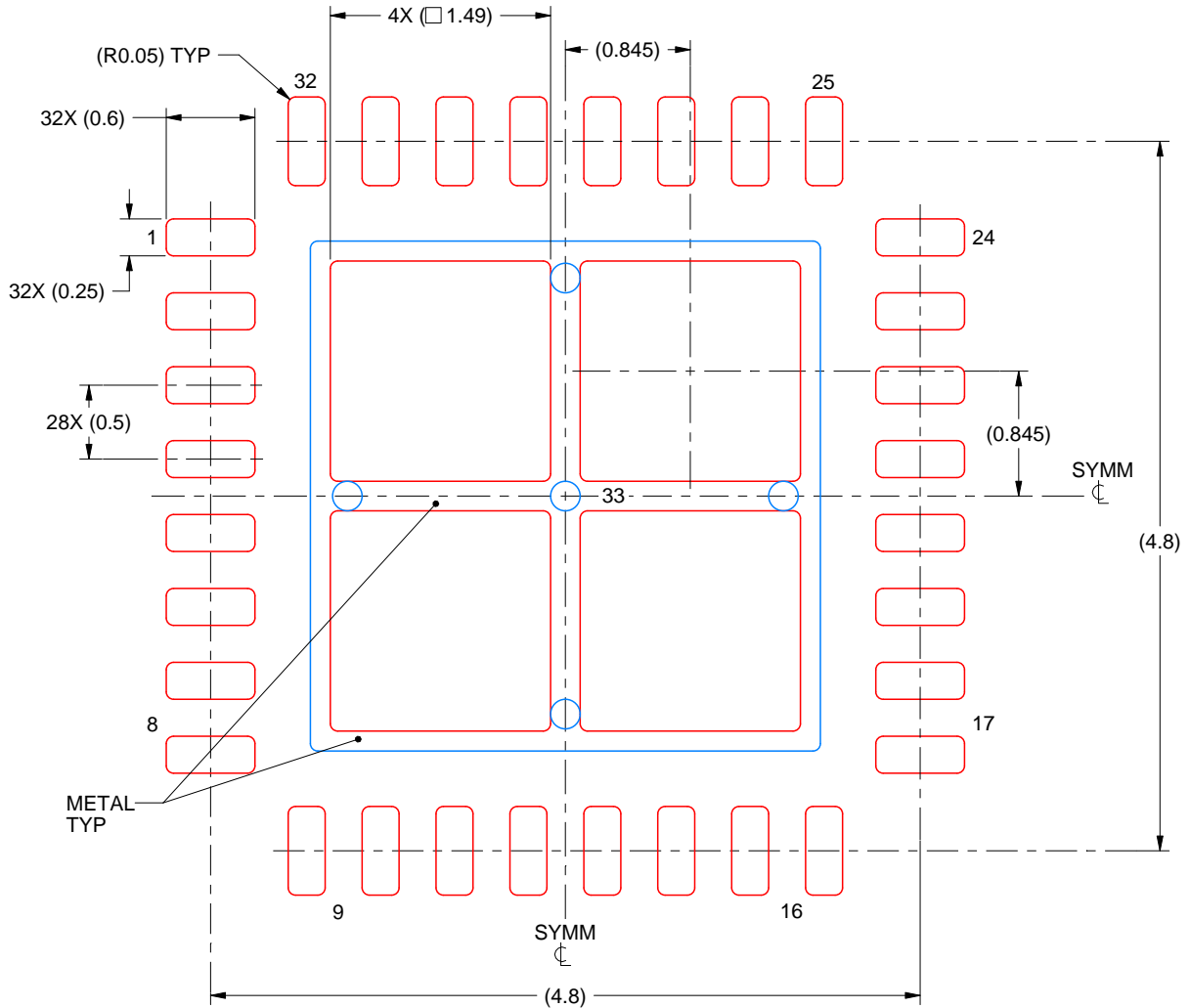

SOLDER PASTE EXAMPLE
 BASED ON 0.125 mm THICK STENCIL

EXPOSED PAD 33:
 75% PRINTED SOLDER COVERAGE BY AREA UNDER PACKAGE
 SCALE:20X

4223442/A 11/2016

NOTES: (continued)

6. Laser cutting apertures with trapezoidal walls and rounded corners may offer better paste release. IPC-7525 may have alternate design recommendations.

IMPORTANT NOTICE AND DISCLAIMER

TI PROVIDES TECHNICAL AND RELIABILITY DATA (INCLUDING DATASHEETS), DESIGN RESOURCES (INCLUDING REFERENCE DESIGNS), APPLICATION OR OTHER DESIGN ADVICE, WEB TOOLS, SAFETY INFORMATION, AND OTHER RESOURCES "AS IS" AND WITH ALL FAULTS, AND DISCLAIMS ALL WARRANTIES, EXPRESS AND IMPLIED, INCLUDING WITHOUT LIMITATION ANY IMPLIED WARRANTIES OF MERCHANTABILITY, FITNESS FOR A PARTICULAR PURPOSE OR NON-INFRINGEMENT OF THIRD PARTY INTELLECTUAL PROPERTY RIGHTS.

These resources are intended for skilled developers designing with TI products. You are solely responsible for (1) selecting the appropriate TI products for your application, (2) designing, validating and testing your application, and (3) ensuring your application meets applicable standards, and any other safety, security, or other requirements. These resources are subject to change without notice. TI grants you permission to use these resources only for development of an application that uses the TI products described in the resource. Other reproduction and display of these resources is prohibited. No license is granted to any other TI intellectual property right or to any third party intellectual property right. TI disclaims responsibility for, and you will fully indemnify TI and its representatives against, any claims, damages, costs, losses, and liabilities arising out of your use of these resources.

TI's products are provided subject to TI's Terms of Sale (www.ti.com/legal/termsofsale.html) or other applicable terms available either on ti.com or provided in conjunction with such TI products. TI's provision of these resources does not expand or otherwise alter TI's applicable warranties or warranty disclaimers for TI products.

Mailing Address: Texas Instruments, Post Office Box 655303, Dallas, Texas 75265
Copyright © 2019, Texas Instruments Incorporated