

Dimensions: mm (in.)

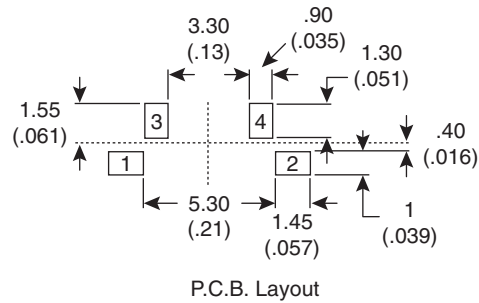
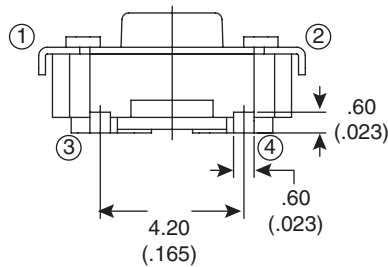
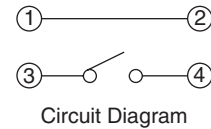
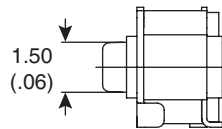
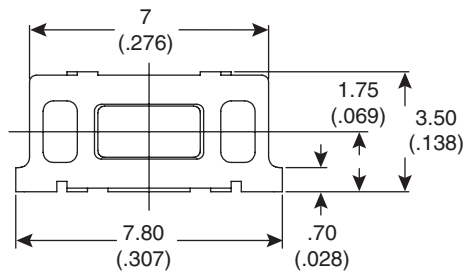
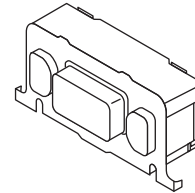
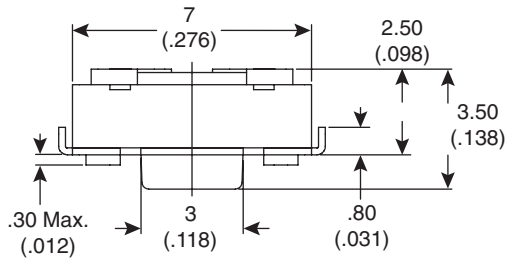

Mechanical Specifications:

- Operation force: 160 ± 50gf Black 101-TS3923R1600-EV
260 ± 50gf Black 101-TS3923R2600-EV
- Stroke: 0.25 + 0.10 mm
- Operating Temperature: -25°C to +70°C
- Storage temperature: -40°C to +80°C

Note:

- RoHS Compliant and process compatible with 260° solder

Electrical Specifications:

- Life: 50,000 cycles for 160gf
30,000 cycles for 260gf
- Rating: 50mA/12VDC
- Contact resistance: 100mΩ max.
- Insulation resistance: 100MΩ min. at 500VDC
- Dielectric strength: 250VAC/ minute
- General tolerance: ±0.2mm (±0.008")

Materials:

- Cover: steel, tin plated
- Base: nylon thermoplastic
Color: white
- STEM: nylon thermoplastic
Color: black (160gf), white (260gf)
- Contact disc: stainless with silver cladding
- Terminal: brass with silver plating

Tactile Switches
101-TS3923R1600-EV, 101-TS3923R2600-EV



Mouser Electronics

Authorized Distributor

Click to View Pricing, Inventory, Delivery & Lifecycle Information:

[Mountain Switch:](#)

[101-TS3923R1600-EV](#) [101-TS3923R2600-EV](#)