

COD	TITLE BENENNUNG	PART-NO. REV	DATE DATUM	AMOUNT ANZAHL	CUSTOMER-NO. KUNDENNUMMER	NOTES BEMERKUNG
Z	CONNECTOR 58 WAY CONNECTOR 58 POL.	15494596 01	18.10.05	0	---	CONDITION OF DELIVERY POS. 1+2 ASSEMBLED LIEFERZUSTAND POS. 1+2 MONTIERT
1	RECEPTACLE HOUSING 58 WAY FLACHSTECKHUELSENBEHAUESE 58 POL.	15494579 ---	---	---	---	ONLY ASSEMBLED PARTS AVAILABLE NUR MONTIERT LIEFERBAR
2	COVER PLATE AND BLOCKSEAL ABDECKPLATTE UND BLOCKDICHTUNG	---	---	---	---	ONLY ASSEMBLED PARTS AVAILABLE NUR MONTIERT LIEFERBAR

COD 1 PART-NO.: 15494579  
CODING/CODIERUNG Z

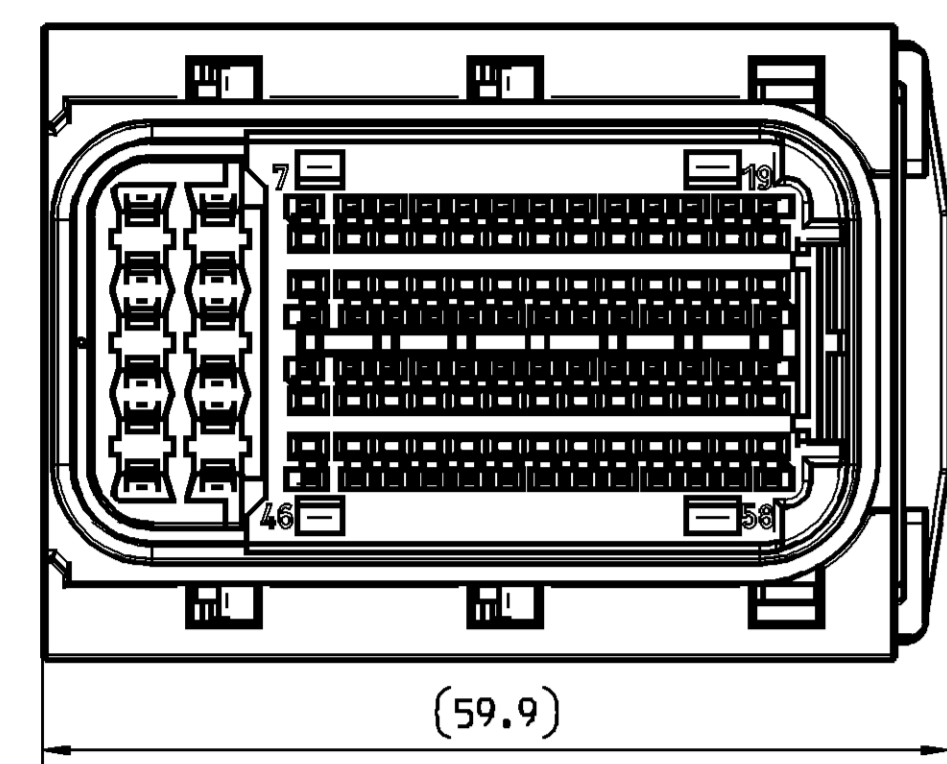

COD	PART-NO.	REV	DATE	VARIANT-NO.
Z	15494596	01	18.10.05	0
2	15494577	---	---	0

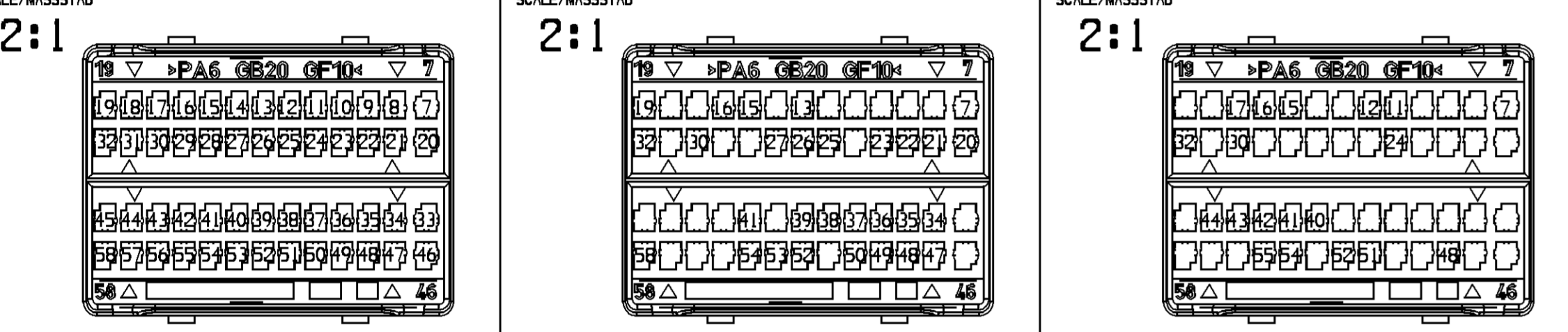

COD	PART-NO.	REV	DATE	VARIANT-NO.
Z	13567756	01	01.06.06	6
2	13567626	---	---	6

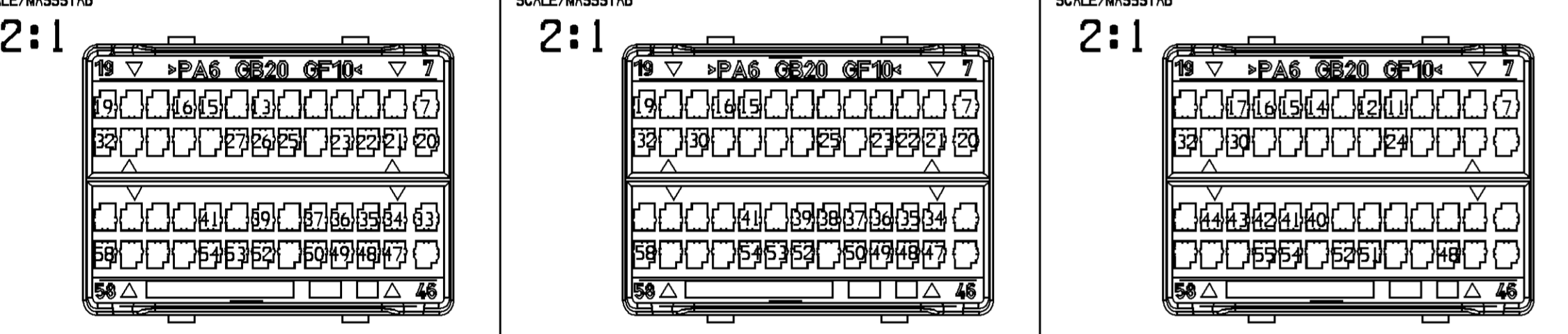

COD	PART-NO.	REV	DATE	VARIANT-NO.
Z	13541379	01	02.05.05	15
2	13541374	---	---	15

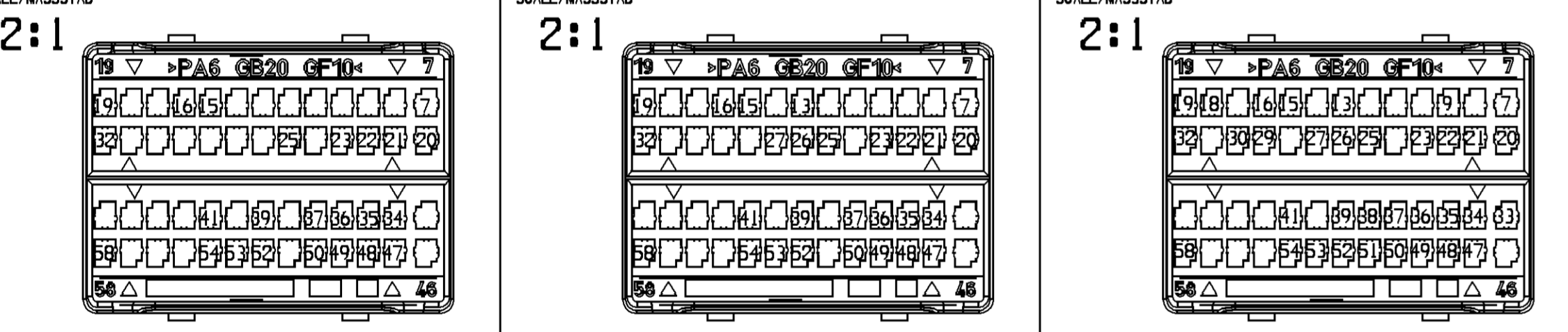

COD	PART-NO.	REV	DATE	VARIANT-NO.
Z	13553262	01	06.06.06	26
2	13577425	---	---	26



COD	PART-NO.	REV	DATE	VARIANT-NO.
Z	13626663	01	12.07.07	40
2	13626662	---	---	40

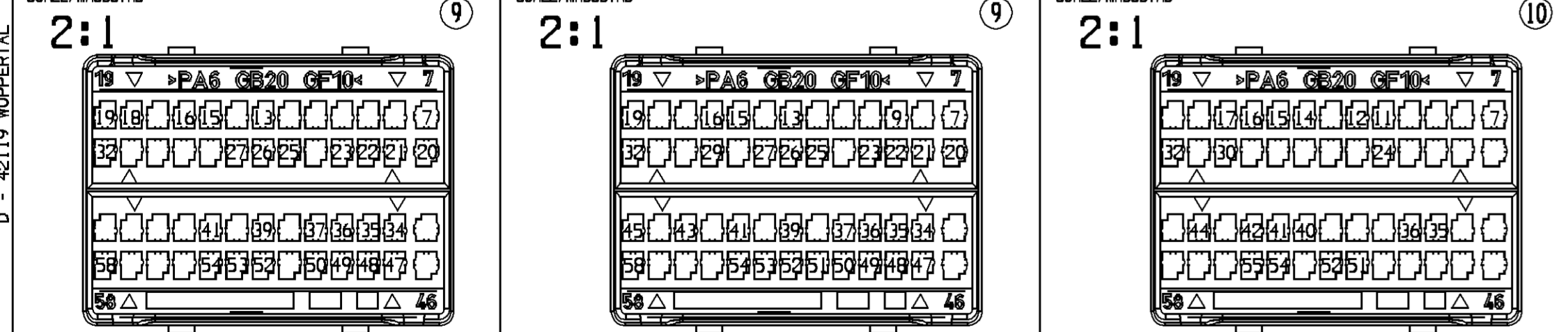

COD	TITLE BENENNUNG	PART-NO. REV	DATE DATUM	AMOUNT ANZAHL	CUSTOMER-NO. KUNDENNUMMER	NOTES BEMERKUNG
A	CONNECTOR 58 WAY CONNECTOR 58 POL.	13553229 ---	---	---	---	CONDITION OF DELIVERY POS. 1+2 ASSEMBLED LIEFERZUSTAND POS. 1+2 MONTIERT
1	RECEPTACLE HOUSING 58 WAY FLACHSTECKHUELSENBEHAUESE 58 POL.	13553229 ---	---	---	---	ONLY ASSEMBLED PARTS AVAILABLE NUR MONTIERT LIEFERBAR
2	COVER PLATE AND BLOCKSEAL ABDECKPLATTE UND BLOCKDICHTUNG	---	---	---	---	ONLY ASSEMBLED PARTS AVAILABLE NUR MONTIERT LIEFERBAR

COD 1 PART-NO.: 13553229  
CODING/CODIERUNG A

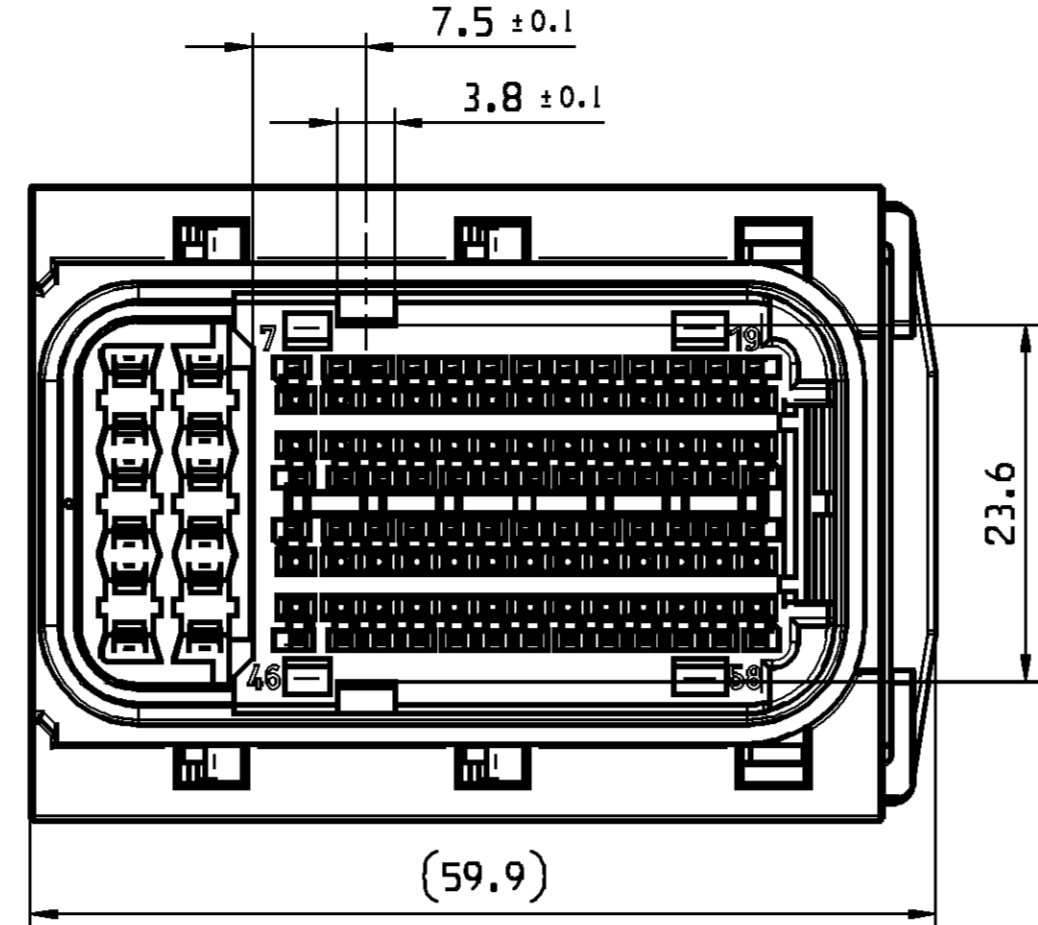

COD	PART-NO.	REV	DATE	VARIANT-NO.
A	1355331	01	18.10.05	0
2	15494577	---	---	0

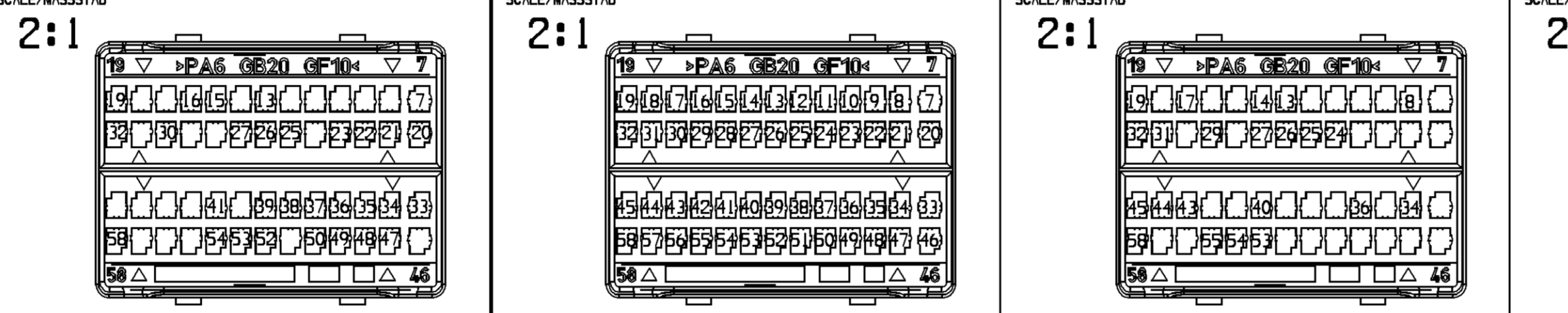

COD	PART-NO.	REV	DATE	VARIANT-NO.
A	13567631	01	01.06.06	19
2	13567627	---	---	19

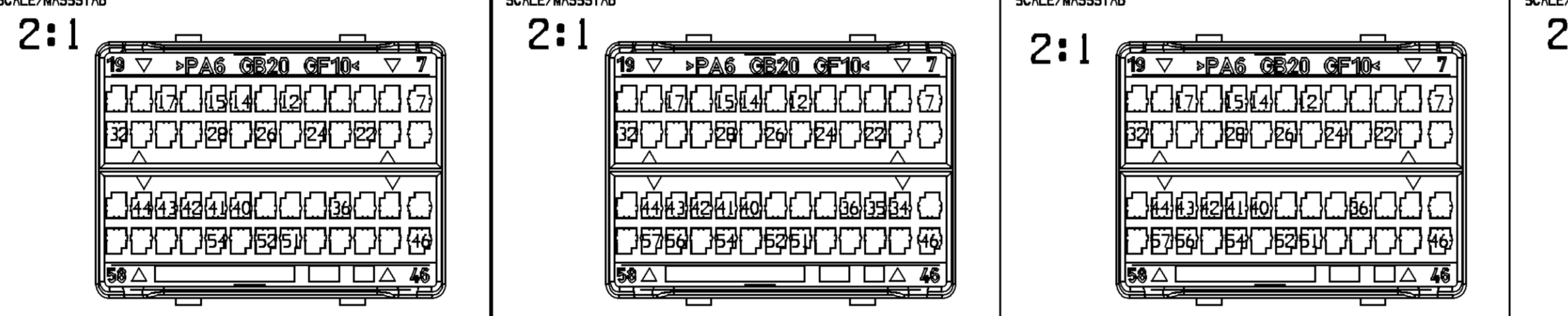

COD	PART-NO.	REV	DATE	VARIANT-NO.
A	13577430	01	06.06.06	25
2	13577424	---	---	25

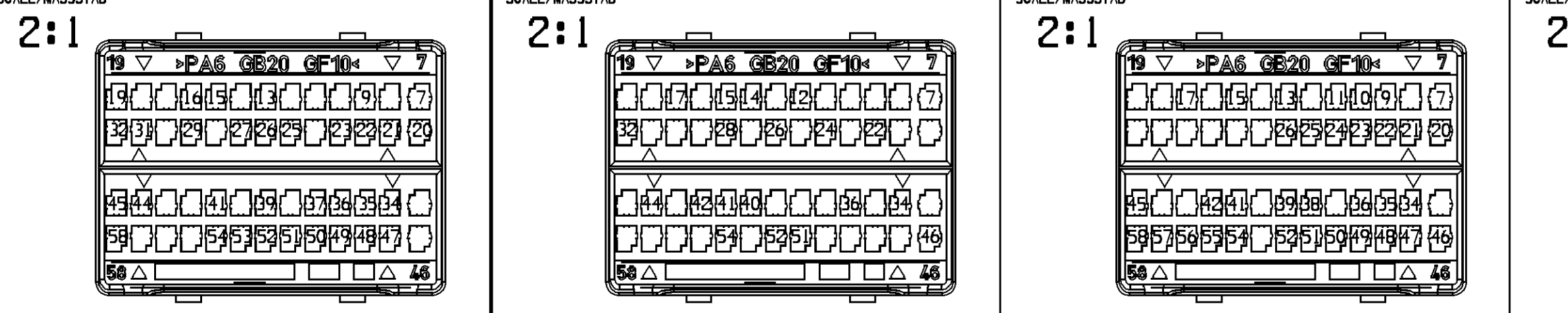

COD	PART-NO.	REV	DATE	VARIANT-NO.
A	13577431	01	06.06.06	28
2	13577427	---	---	28

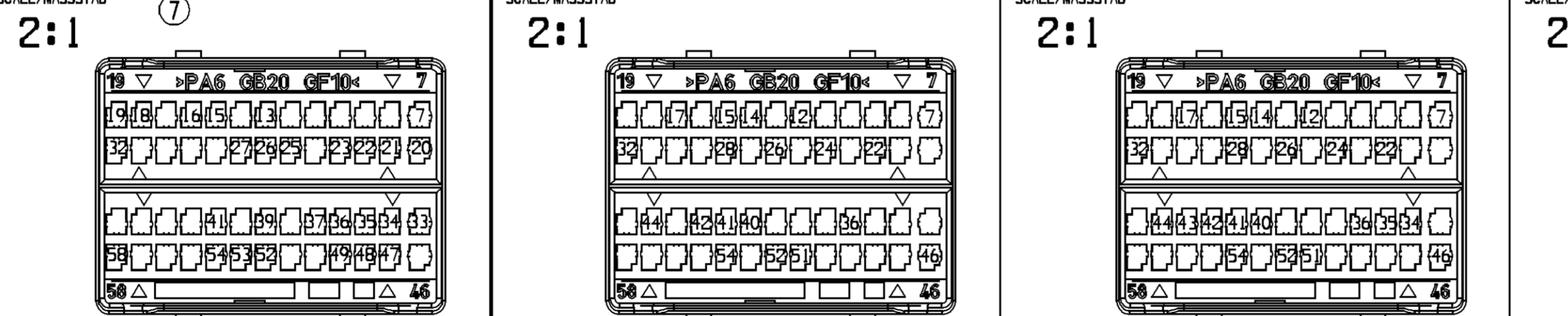

COD	PART-NO.	REV	DATE	VARIANT-NO.
A	13577432	01	06.06.06	29
2	13577428	---	---	29

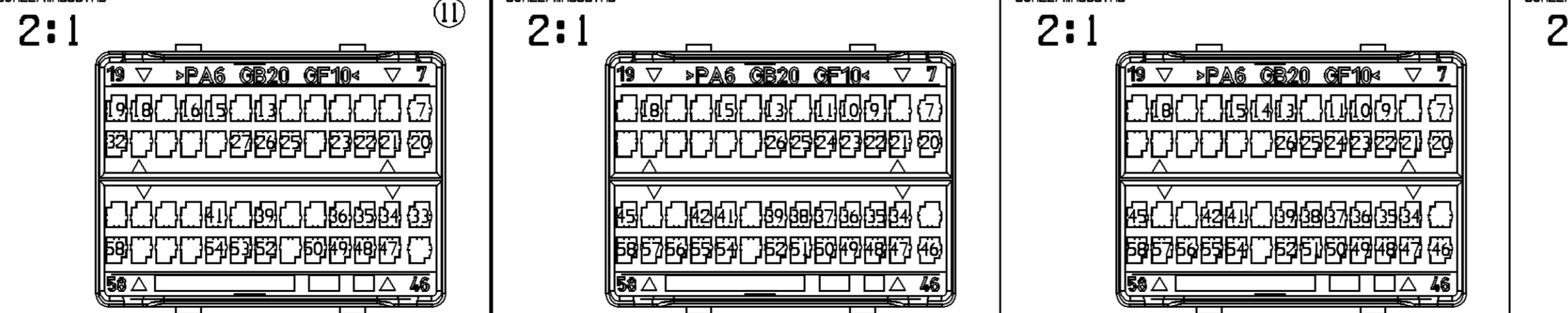

COD	TITLE BENENNUNG	PART-NO. REV	DATE DATUM	AMOUNT ANZAHL	CUSTOMER-NO. KUNDENNUMMER	NOTES BEMERKUNG
E	CONNECTOR 58 WAY CONNECTOR 58 POL.	13528315 ---	---	---	---	CONDITION OF DELIVERY POS. 1+2 ASSEMBLED LIEFERZUSTAND POS. 1+2 MONTIERT
1	RECEPTACLE HOUSING 58 WAY FLACHSTECKHUELSENBEHAUESE 58 POL.	13528315 ---	---	---	---	ONLY ASSEMBLED PARTS AVAILABLE NUR MONTIERT LIEFERBAR
2	COVER PLATE AND BLOCKSEAL ABDECKPLATTE UND BLOCKDICHTUNG	---	---	---	---	ONLY ASSEMBLED PARTS AVAILABLE NUR MONTIERT LIEFERBAR

COD 1 PART-NO.: 13528315  
CODING/CODIERUNG E

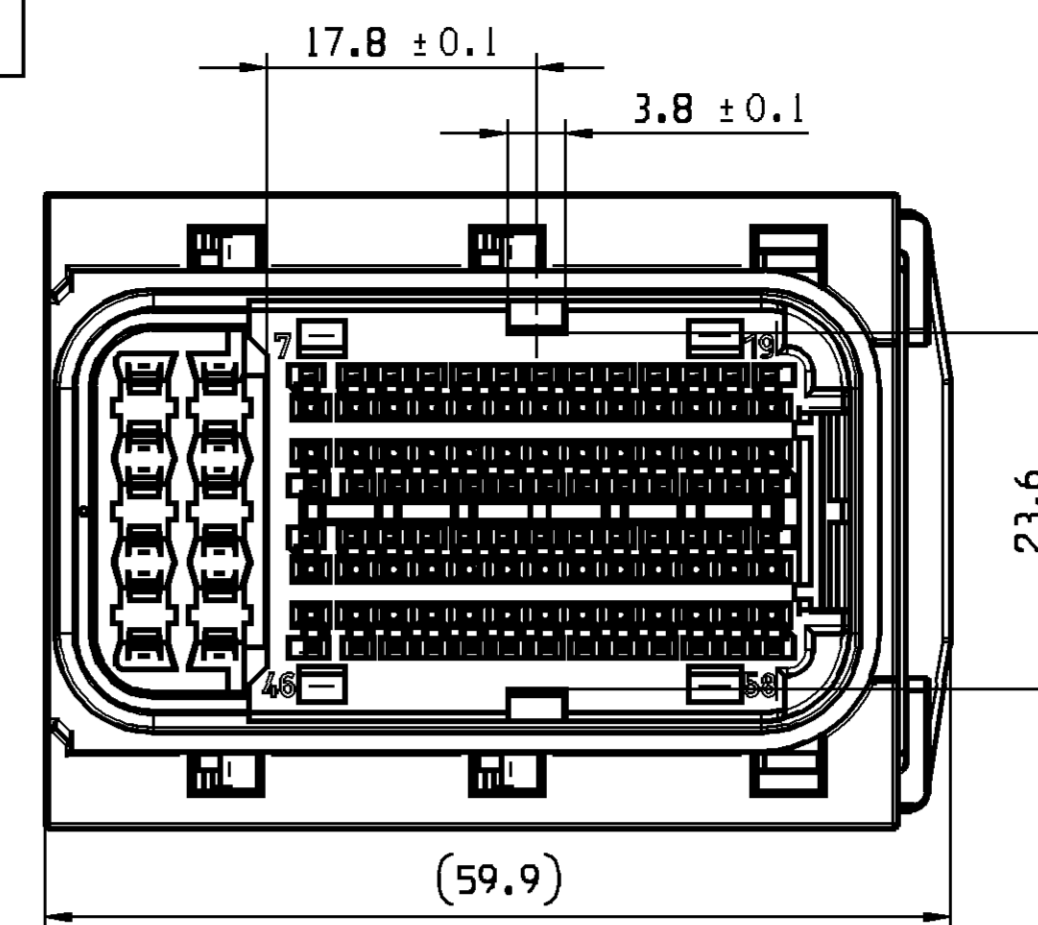

COD	PART-NO.	REV	DATE	VARIANT-NO.
E	1355332	01	18.10.05	0
2	15494577	---	---	0

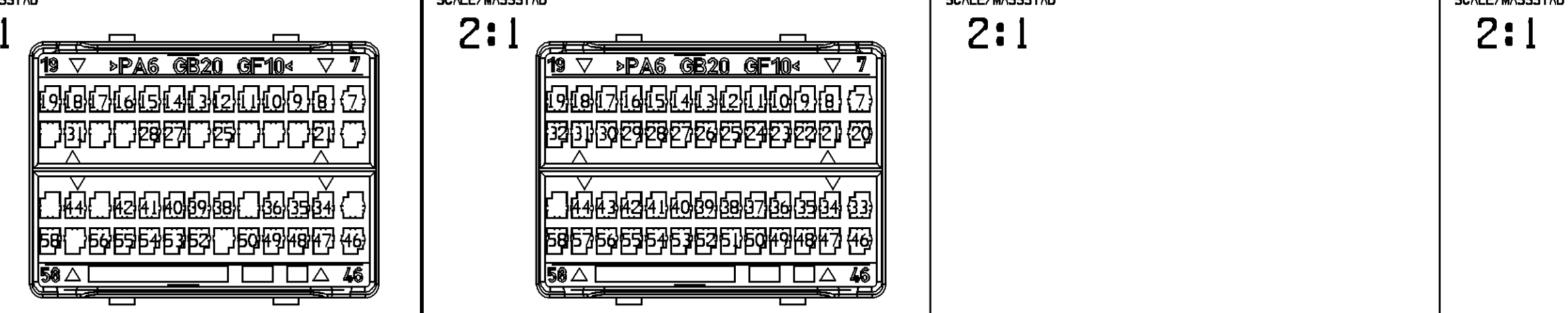

COD	PART-NO.	REV	DATE	VARIANT-NO.
E	---	---	---	---
2	---	---	---	---

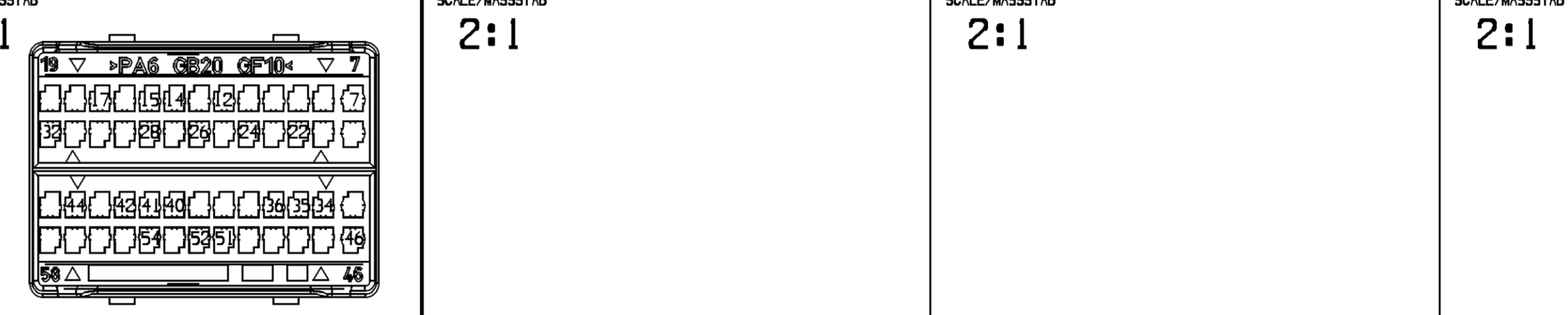

COD	PART-NO.	REV	DATE	VARIANT-NO.
E	---	---	---	---
2	---	---	---	---

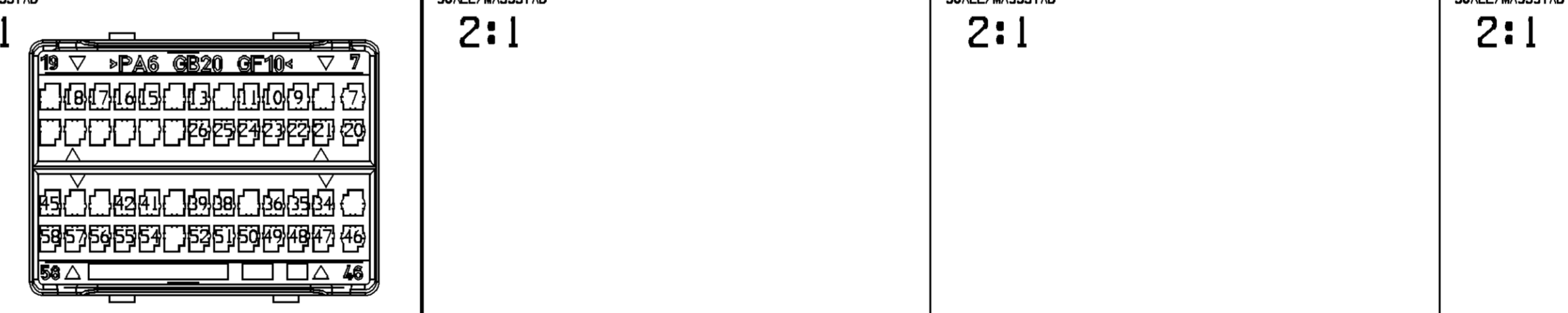

COD	PART-NO.	REV	DATE	VARIANT-NO.
E	---	---	---	---
2	---	---	---	---

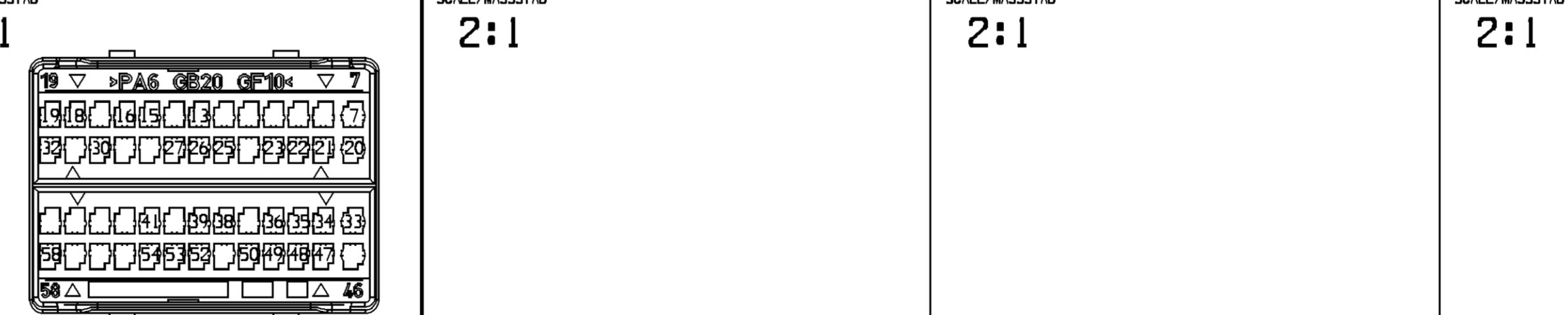

COD	PART-NO.	REV	DATE	VARIANT-NO.
E	---	---	---	---
2	---	---	---	---

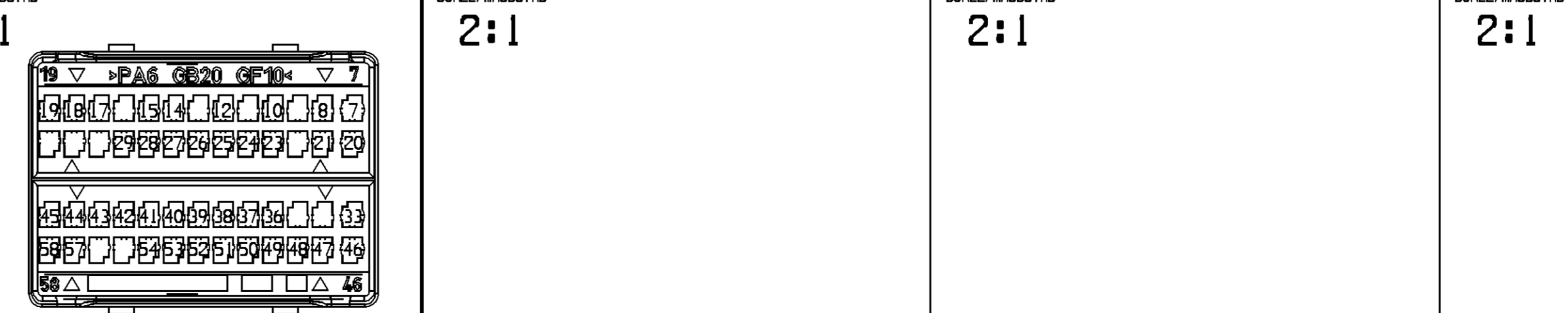

ZONE	REV	DATE	NAME	CHECK	STOCK
01	01	14.10.05	T.SWIE	STOR.	M.SKR.
02	02	18.10.05	T.SWIE	STOR.	M.SKR.
03	03	23.10.05	T.SWIE	STOR.	M.SKR.
04	04	02.05.06	T.SWIE	STOR.	M.SKR.
05	05	19.10.06	V.KAS.	STOR.	MICHA.
06	06	06.06.06	V.KAS.	STOR.	MICHA.
07	07	02.10.06	W.SZO.	STOR.	M.SKR.
08	08	27.06.06	W.SZO.	STOR.	M.SKR.
09	09	12.07.07	W.SZO.	STOR.	P.LES.
10	10	20.07.07	W.TAR.	STOR.	P.LES.
11	11	27.07.07	A.STA.	STOR.	M.SKR.
12	12	17.10.07	W.SZO.	STOR.	K.PIT.
13	13	19.05.07	W.TAR.	STOR.	M.SKR.

COD	PART-NO.	REV	DATE	VARIANT-NO.
E	---	---	---	---
2	---	---	---	---

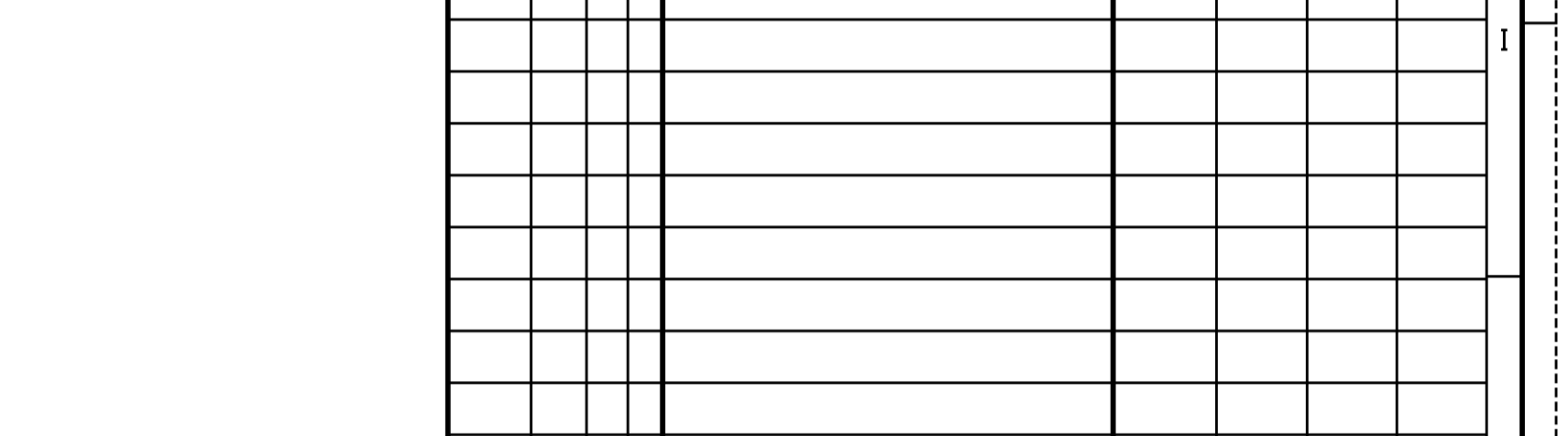

COD	PART-NO.	REV	DATE	VARIANT-NO.
E	---	---	---	---
2	---	---	---	---

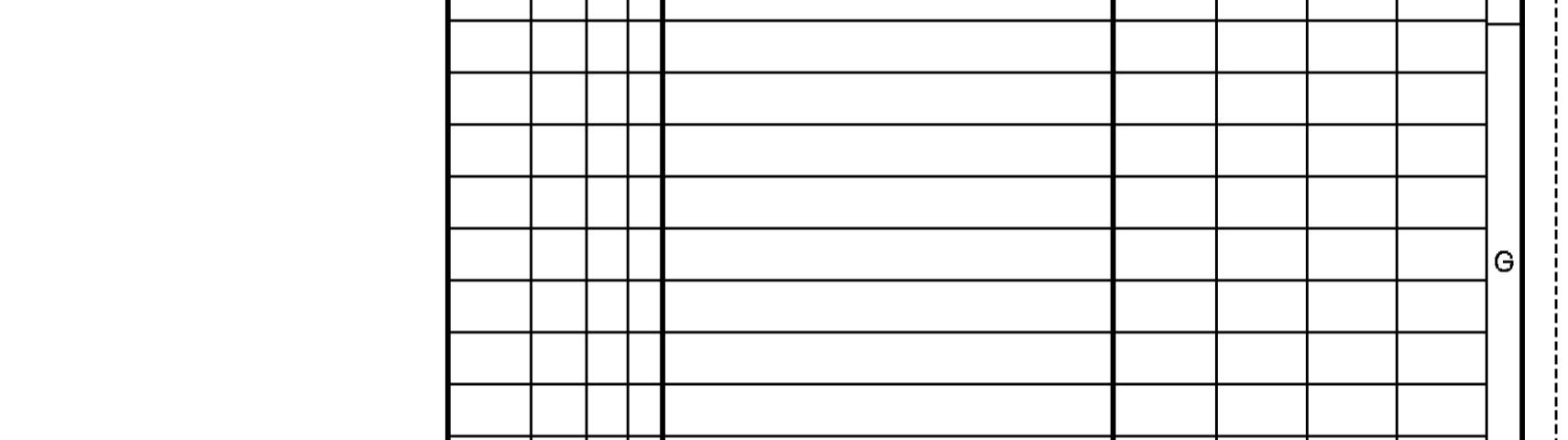

COD	PART-NO.	REV	DATE	VARIANT-NO.
E	---	---	---	---
2	---	---	---	---

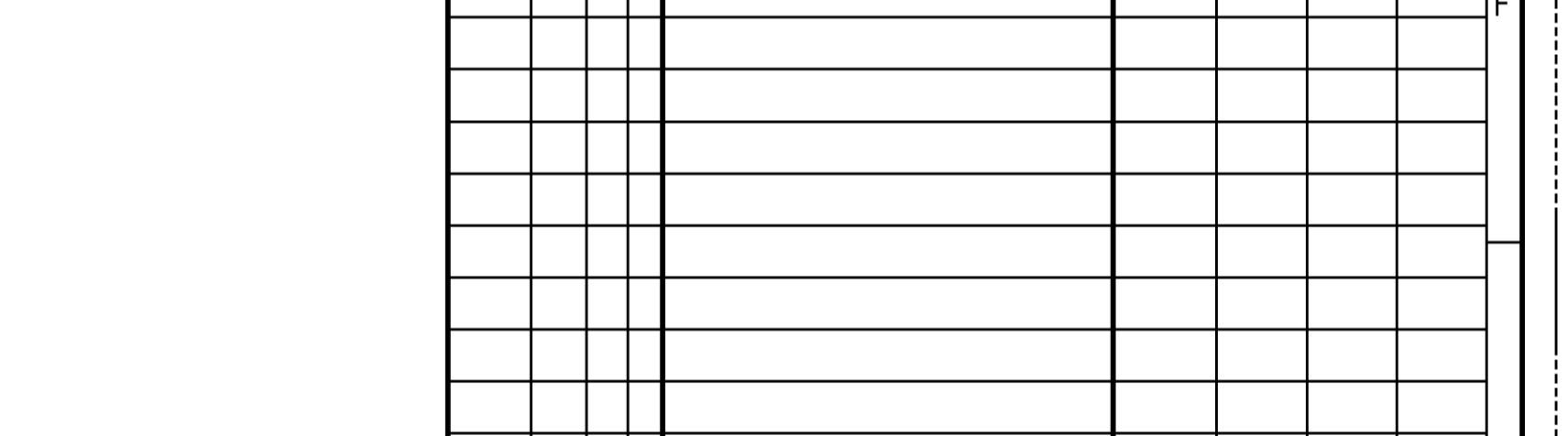

COD	PART-NO.	REV	DATE	VARIANT-NO.
E	---	---	---	---
2	---	---	---	---

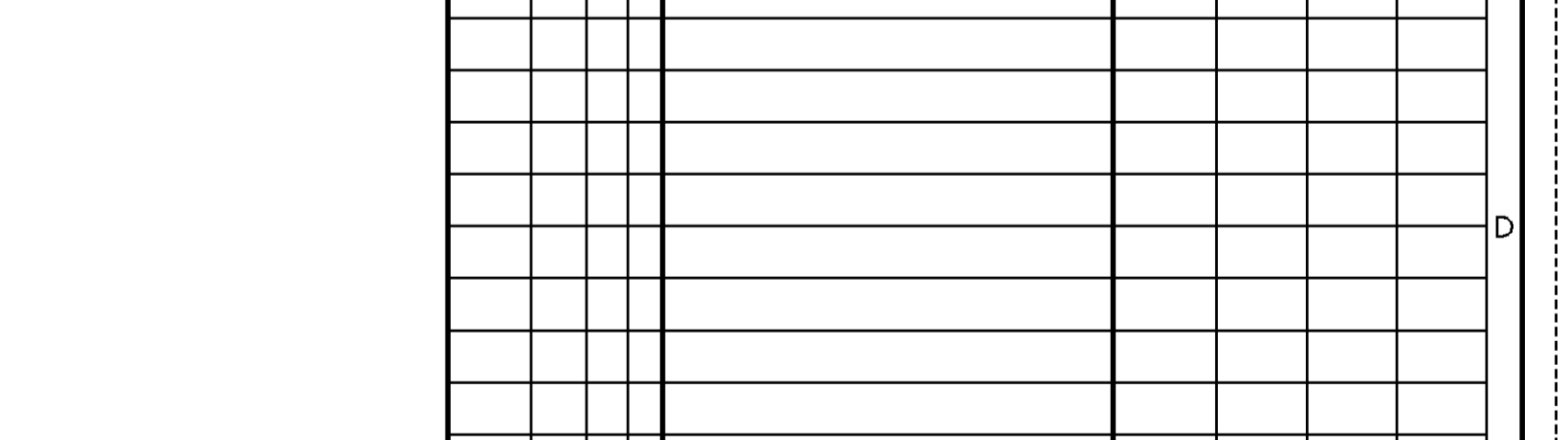

COD	PART-NO.	REV	DATE	VARIANT-NO.
E	---	---	---	---
2	---	---	---	---

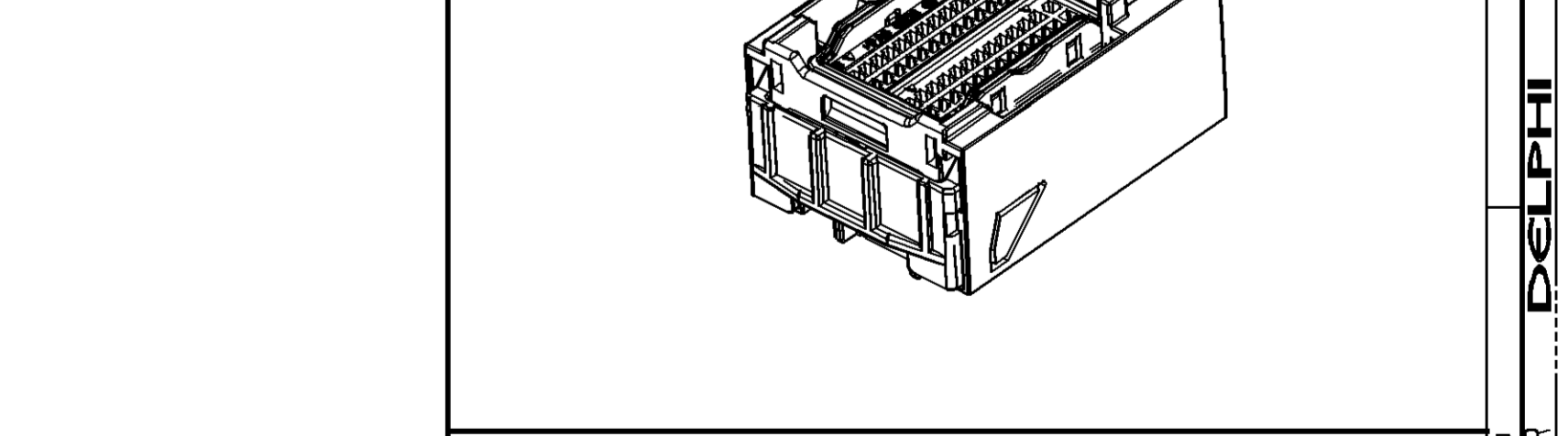

REMARKS:  
- IN CASE OF PART MODIFICATION CHECK ASSEMBLY TOOLS AND TEST EQUIPMENT AT THE CUSTOMER AND THE SUPPLIER  
- LETTERS AND ENGRAVINGS 0.2 MM RAISED  
- MARK PLASTIC PARTS PER VDA 260  
- BLANKED CAVITIES INDICATE CLOSED LOCATION  
- CAVITIES 7; 20; 33; 46 FOR TERMINALS WITH OUTER DIAMETER 1.4-2.1 MM (TYCO 1394897-3; 1452503-3 OR EQUIVALENT) CRIMPDIMENSIONS SEE ESD 20703-CUS01-502  
- CAVITIES 8-19; 21-32; 34-45; 47-58 FOR TERMINALS WITH OUTER DIAMETER 1.4-1.9 MM (TYCO 1394897-3 OR EQUIVALENT) CRIMPDIMENSIONS SEE ESD 20702-CUS01-502  
- COMPATIBLY COVER AND LEVER SEE DWG-NO.: 15494582

BEMERKUNGEN:  
- BEI ARTIKELÄNDERUNG AUF MONTAGE UND PRUEFEQUIPMENT BEIM KUNDEN SOWIE BEIM LIEFERANTEN ACHTEN  
- SCHRIFTEN UND GRAVUREN 0.2 MM ERHABEN  
- KUNSTSTOFFTEILE NACH VDA 260  
- LEERE FELDER KENNZEICHNEN GESCHLOSSENE KAMMERN  
- KAMMERN 7; 20; 33; 46 FUER KONTAKTE MIT AUSSENDURCHMESSER 1.4-2.1 MM (TYCO 1394897-3; 1452503-3 ODER VERGLEICHBAR) CRIMPMASSSE SIEHE ESD 20703-CUS01-502  
- KAMMERN 8-19; 21-32; 34-45; 47-58 FUER KONTAKTE MIT AUSSENDURCHMESSER 1.4-1.9 MM (TYCO 1394897-3 ODER VERGLEICHBAR) CRIMPMASSSE SIEHE ESD 20702-CUS01-502  
- PASSENDER DECKEL MIT BUEGEL SIEHE DWG-NO.: 15494582

KEY PRODUCT CHARACTERISTICS			
NO & TYPE	DESCRIPTION	RATIONALE	PTS
1	SAFETY/COMPLIANCE		0
2	FIT/FUNCTION		0
3	S/C CHECKPOINTS		0
4	F/F CHECKPOINTS		0

DELPHI

CONNECTOR 58 WAY FOR TERMINAL 1.5 AND 2.8 CONNECTOR 58 POL. FUER KONTAKTSYSTEM 1.2 UND 2.8

15494597 01-02 KZUS

SEE CHART / SIEHE TABELLE

PROJECTION: 1ST ANGLE

DRAWING NO.: 15494597

DATE: 13.10.05

SCALE: 2:1

FORM: A0

# Mouser Electronics

Authorized Distributor

Click to View Pricing, Inventory, Delivery & Lifecycle Information:

[Aptiv:](#)

[15494596](#) [15494596-B](#)