

## Product Summary

BV <sub>DSS</sub>	Max R <sub>DS(on)</sub>	Max I <sub>D</sub> T <sub>A</sub> = +25°C (Note 6)
100V	230mΩ @ V <sub>GS</sub> = 10V	1.9A
	300mΩ @ V <sub>GS</sub> = 4.5V	1.68A

## Description and Applications

This MOSFET utilizes a unique structure that combines the benefits of low on-resistance with fast switching speed. This makes it ideal for high-efficiency, low voltage, power management applications.

- DC - DC Converters
- Power Management Functions
- Disconnect Switches
- Motor Control



Top View

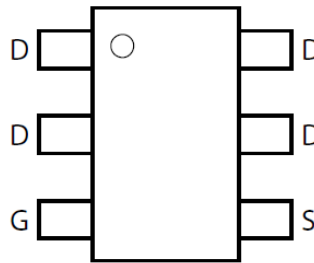

Pinout Top-view

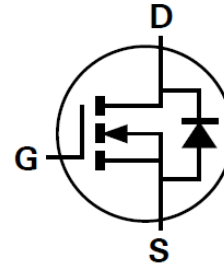

Device Symbol

## Features and Benefits

- Low On-Resistance
- Fast Switching Speed
- Low Threshold
- Low Gate Drive
- SOT26 Package
- **Totally Lead-Free & Fully RoHS Compliant (Notes 1 & 2)**
- **Halogen and Antimony Free. "Green" Device (Note 3)**
- **Qualified to AEC-Q101 Standards for High Reliability**

## Mechanical Data

- Case: SOT26
- Case Material: Molded Plastic, "Green" Molding Compound. UL Flammability Classification Rating 94V-0
- Moisture Sensitivity: Level 1 per J-STD-020
- Terminals: Finish – Matte Tin Annealed over Copper Leadframe. Solderable per MIL-STD-202, Method 208
- Weight: 0.015 grams (Approximate)

## Ordering Information (Note 4)

Part Number	Reel Size (inch)	Tape Width (mm)	Quantity Per Reel
ZXMN10B08E6TA	7	8	3,000
ZXMN10B08E6TC	13	8	10,000

- Notes:
1. No purposely added lead. Fully EU Directive 2002/95/EC (RoHS) & 2011/65/EU (RoHS 2) compliant.
  2. See [http://www.diodes.com/quality/lead\\_free.html](http://www.diodes.com/quality/lead_free.html) for more information about Diodes Incorporated's definitions of Halogen- and Antimony-free, "Green" and Lead-free.
  3. Halogen- and Antimony-free "Green" products are defined as those which contain <900ppm bromine, <900ppm chlorine (<1500ppm total Br + Cl) and <1000ppm antimony compounds.
  4. For packaging details, go to our website at <http://www.diodes.com>.

## Marking Information

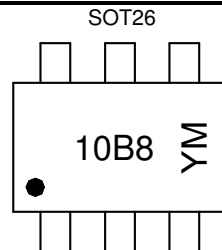

10B8 = Product Type Marking Code  
 YM = Date Code Marking  
 Y or  $\bar{Y}$  = Year (ex: C = 2015)  
 M or  $\bar{M}$  = Month (ex: 9 = September)

### Date Code Key

Year	2015	2016	2017	2018	2019	2020	2021	2022
Code	C	D	E	F	G	H	I	J

Month	Jan	Feb	Mar	Apr	May	Jun	Jul	Aug	Sep	Oct	Nov	Dec
Code	1	2	3	4	5	6	7	8	9	O	N	D

**Maximum Ratings** (@T<sub>A</sub> = +25°C, unless otherwise specified.)

Characteristic		Symbol	Value	Unit	
Drain-Source Voltage		V <sub>DSS</sub>	100	V	
Gate-Source Voltage		V <sub>GSS</sub>	±20	V	
Continuous Drain Current	V <sub>GS</sub> = 10V	I <sub>D</sub>	(Note 6)	1.9	A
			T <sub>A</sub> = +70°C (Note 6)	1.5	
			(Note 5)	1.6	
Pulsed Drain Current		I <sub>DM</sub>	9	A	
Continuous Source Current (Body Diode)		I <sub>S</sub>	2.5	A	
Pulsed Source Current (Body Diode)		I <sub>SM</sub>	9	A	

**Thermal Characteristics** (@T<sub>A</sub> = +25°C, unless otherwise specified.)

Characteristic		Symbol	Value	Unit
Power Dissipation	(Note 5)	P <sub>D</sub>	1.1	W
			8.8	
Power Dissipation	(Note 6)	P <sub>D</sub>	1.7	W
			13.6	
Thermal Resistance, Junction to Ambient	(Note 5)	R <sub>θJA</sub>	113	°C/W
	(Note 6)		73	
Operating and Storage Temperature Range		T <sub>J</sub> , T <sub>STG</sub>	-55 to +150	°C

- Notes:
- For a device surface mounted on 25mm x 25mm FR4 PCB with high coverage of single sided 1oz copper, in still air conditions.
  - For a device surface mounted on FR4 PCB measured at t ≤ 5 secs.
  - Repetitive rating 25mm x 25mm FR4 PCB, D = 0.02, pulse width 300µs - pulse width limited by maximum junction temperature. Refer to Transient Thermal Impedance graph.

**Thermal Characteristics**

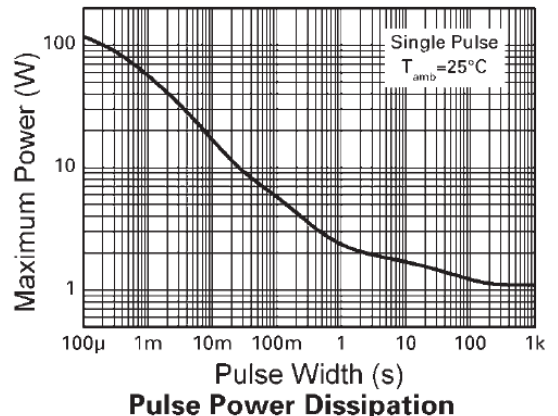
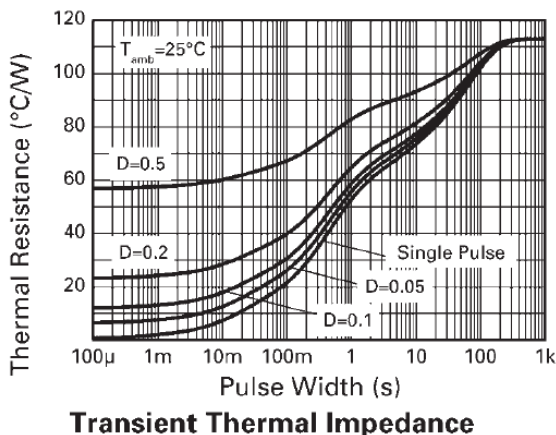
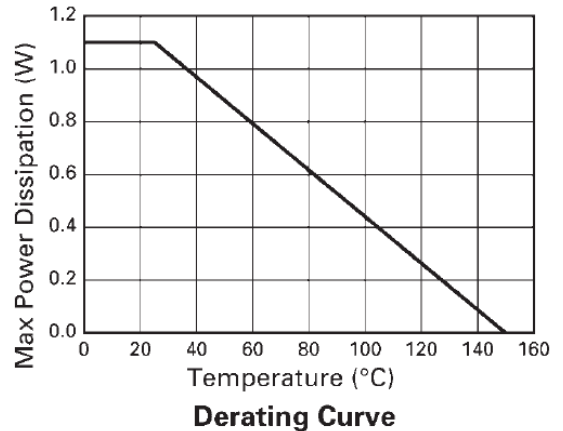
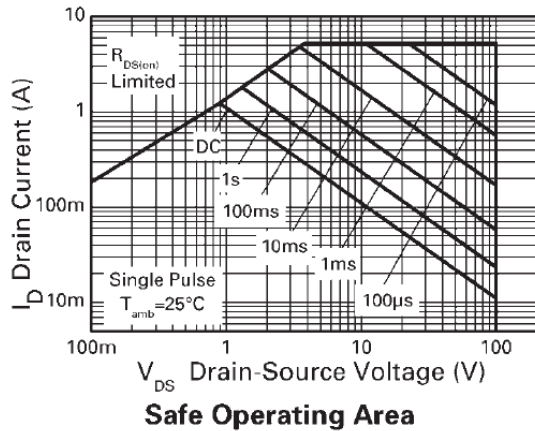

**Electrical Characteristics** (@T<sub>A</sub> = +25°C, unless otherwise specified.)

Characteristic	Symbol	Min	Typ	Max	Unit	Test Condition
<b>OFF CHARACTERISTICS</b>						
Drain-Source Breakdown Voltage	BV <sub>DSS</sub>	100	—	—	V	I <sub>D</sub> = 250μA, V <sub>GS</sub> = 0V
Zero Gate Voltage Drain Current	I <sub>DSS</sub>	—	—	0.5	μA	V <sub>DS</sub> = 100V, V <sub>GS</sub> = 0V
Gate-Source Leakage	I <sub>GSS</sub>	—	—	100	nA	V <sub>GS</sub> = ±20V, V <sub>DS</sub> = 0V
<b>ON CHARACTERISTICS</b>						
Gate Threshold Voltage	V <sub>GS(th)</sub>	1.0	—	3.0	V	I <sub>D</sub> = 250μA, V <sub>DS</sub> = V <sub>GS</sub>
Static Drain-Source On-Resistance (Note 8)	R <sub>DS(ON)</sub>	—	—	0.23	Ω	V <sub>GS</sub> = 10V, I <sub>D</sub> = 1.6A
				0.30		V <sub>GS</sub> = 4.5V, I <sub>D</sub> = 1.4A
				0.50		V <sub>GS</sub> = 4.3V, I <sub>D</sub> = 1.1A
Forward Transconductance (Notes 8 & 10)	g <sub>fs</sub>	—	4.8	—	S	V <sub>DS</sub> = 15V, I <sub>D</sub> = 1.6A
Diode Forward Voltage (Note 8)	V <sub>SD</sub>	—	0.85	0.95	V	T <sub>J</sub> = +25°C, I <sub>S</sub> = 2.0A, V <sub>GS</sub> = 0V
<b>DYNAMIC CHARACTERISTICS (Note 10)</b>						
Input Capacitance	C <sub>iss</sub>	—	497	—	pF	V <sub>DS</sub> = 50V, V <sub>GS</sub> = 0V f = 1.0MHz
Output Capacitance	C <sub>oss</sub>	—	29	—	pF	
Reverse Transfer Capacitance	C <sub>rss</sub>	—	18	—	pF	
Gate Charge (Note 9)	Q <sub>g</sub>	—	5.0	—	nC	V <sub>DS</sub> = 50V, V <sub>GS</sub> = 5V, I <sub>D</sub> = 1.6A
Total Gate Charge (Note 9)	Q <sub>g</sub>	—	9.2	—	nC	V <sub>DS</sub> = 50V, V <sub>GS</sub> = 10V, I <sub>D</sub> = 1.6A
Gate-Source Charge (Note 9)	Q <sub>gs</sub>	—	1.7	—	nC	
Gate-Drain Charge (Note 9)	Q <sub>gd</sub>	—	2.5	—	nC	
Turn-On Delay Time (Note 9)	t <sub>d(on)</sub>	—	2.9	—	ns	V <sub>DD</sub> = 50V, I <sub>D</sub> = 1.0A, R <sub>G</sub> ≅ 6.0Ω, V <sub>GS</sub> = 10V
Turn-On Rise Time (Note 9)	t <sub>r</sub>	—	2.1	—	ns	
Turn-Off Delay Time (Note 9)	t <sub>d(off)</sub>	—	12.1	—	ns	
Turn-Off Fall Time (Note 9)	t <sub>f</sub>	—	5.0	—	ns	
Reverse Recovery Time	t <sub>rr</sub>	—	32	—	ns	
Reverse Recovery Charge	Q <sub>rr</sub>	—	40	—	nC	T <sub>J</sub> = +25°C, I <sub>F</sub> = 1.7A, di/dt = 100A/μs

- Notes:
8. Measured under pulsed conditions. Width ≤ 300μs. Duty cycle ≤ 2%.
  9. Switching characteristics are independent of operating junction temperature.
  10. For design aid only, not subject to production testing.

**Typical Characteristics**

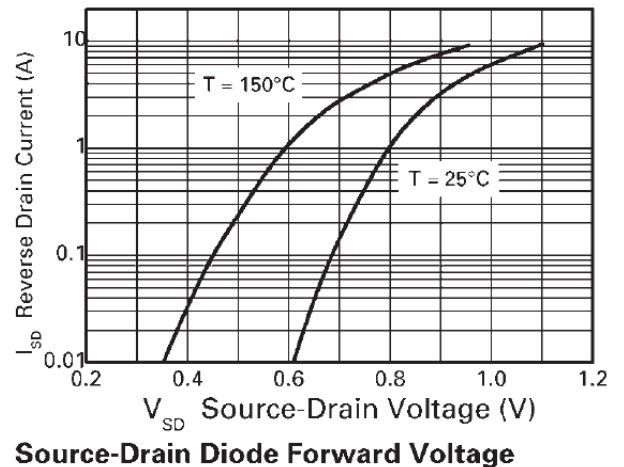
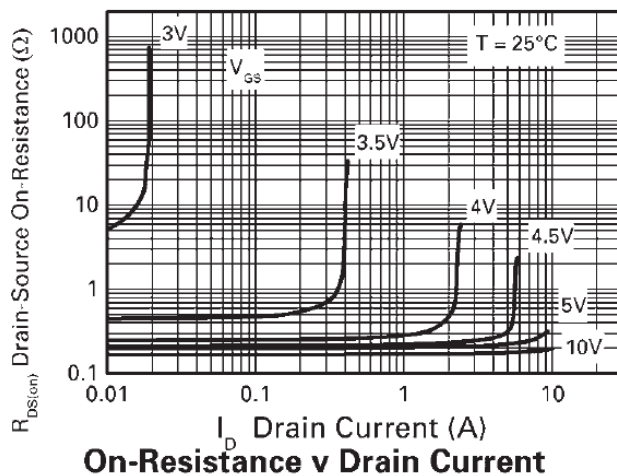
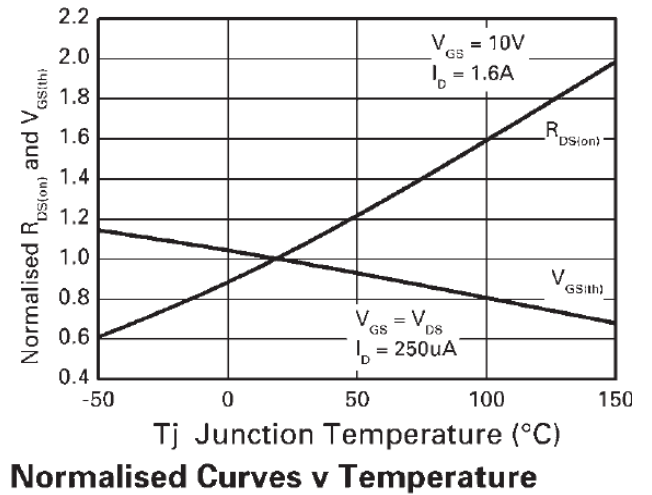
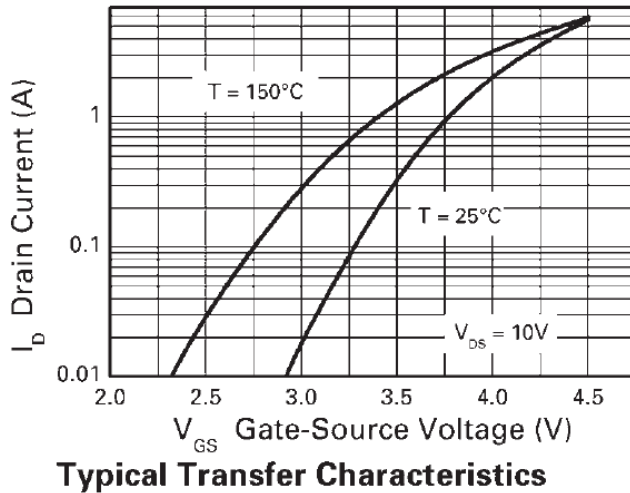
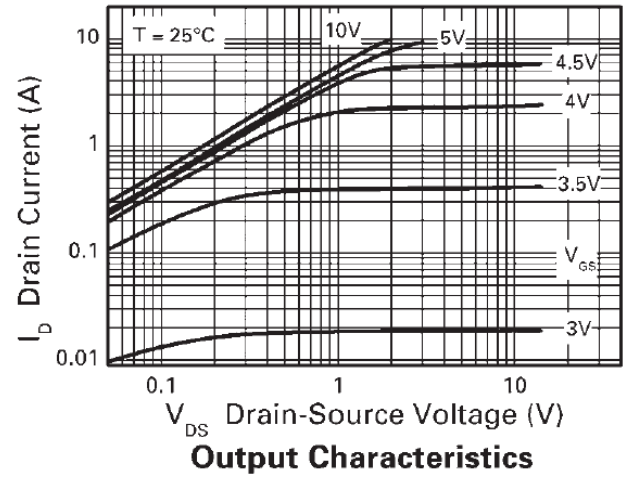
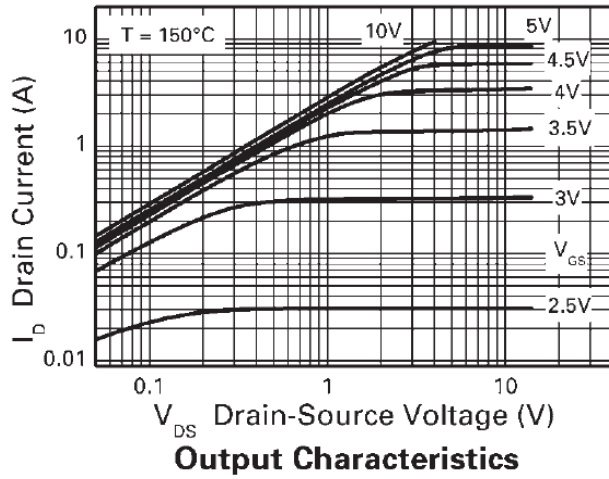

**Typical Characteristics** (continued)

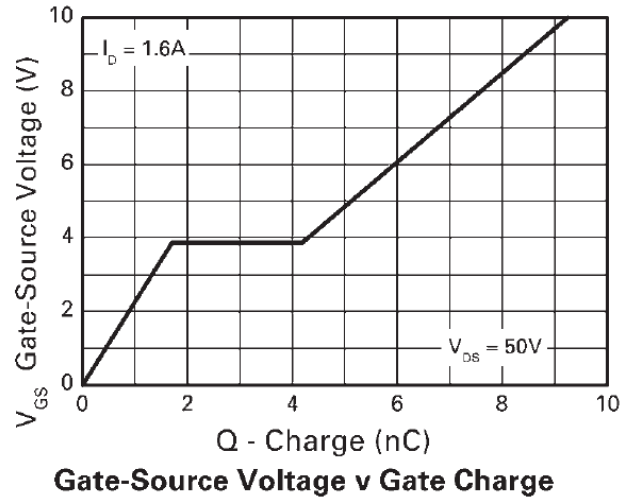
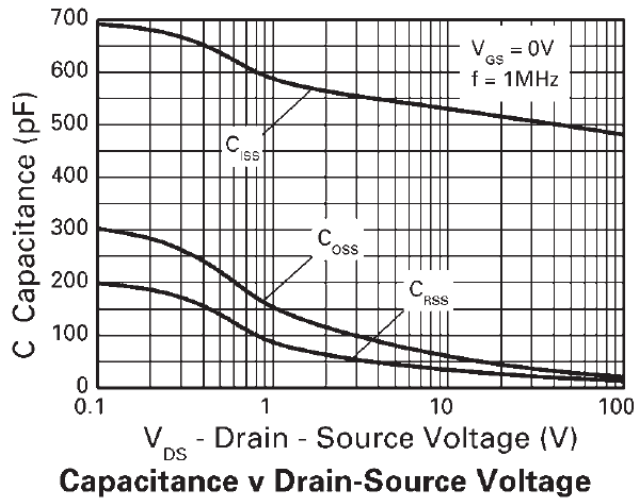

**Test Circuits**

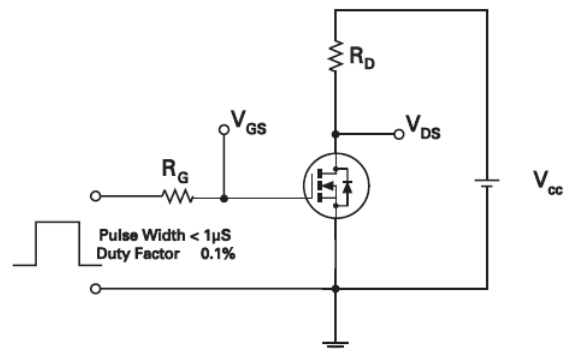
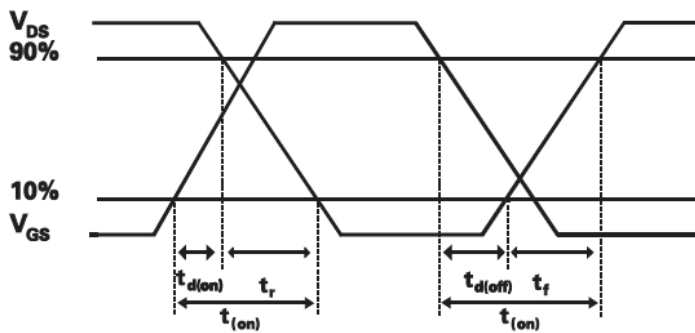
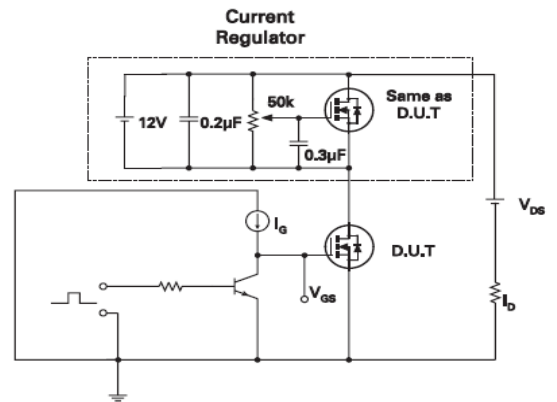
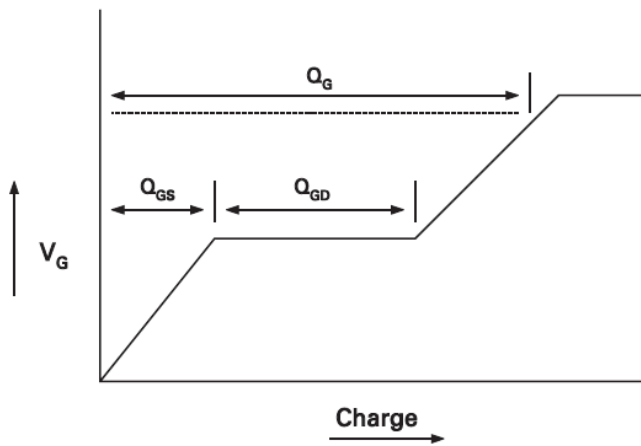

**Package Outline Dimensions**

Please see AP02002 at <http://www.diodes.com/datasheets/ap02002.pdf> for the latest version.

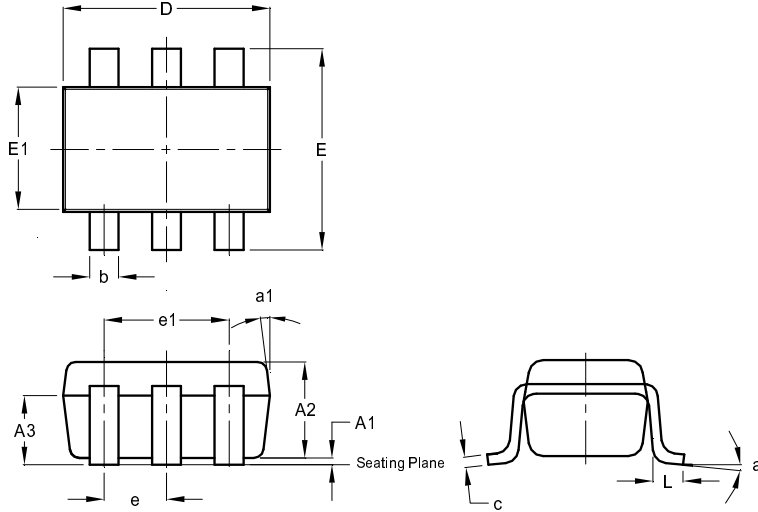

SOT26			
Dim	Min	Max	Typ
A1	0.013	0.10	0.05
A2	1.00	1.30	1.10
A3	0.70	0.80	0.75
b	0.35	0.50	0.38
c	0.10	0.20	0.15
D	2.90	3.10	3.00
e	-	-	0.95
e1	-	-	1.90
E	2.70	3.00	2.80
E1	1.50	1.70	1.60
L	0.35	0.55	0.40
a	-	-	8°
a1	-	-	7°
All Dimensions in mm			

**Suggested Pad Layout**

Please see AP02001 at <http://www.diodes.com/datasheets/ap02001.pdf> for the latest version.

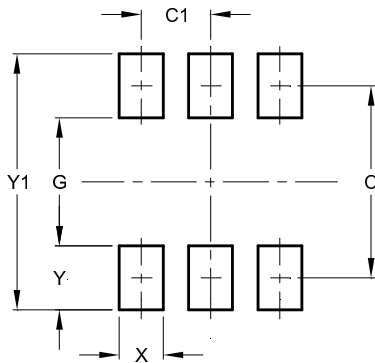

Dimensions	Value (in mm)
C	2.40
C1	0.95
G	1.60
X	0.55
Y	0.80
Y1	3.20

**IMPORTANT NOTICE**

DIODES INCORPORATED MAKES NO WARRANTY OF ANY KIND, EXPRESS OR IMPLIED, WITH REGARDS TO THIS DOCUMENT, INCLUDING, BUT NOT LIMITED TO, THE IMPLIED WARRANTIES OF MERCHANTABILITY AND FITNESS FOR A PARTICULAR PURPOSE (AND THEIR EQUIVALENTS UNDER THE LAWS OF ANY JURISDICTION).

Diodes Incorporated and its subsidiaries reserve the right to make modifications, enhancements, improvements, corrections or other changes without further notice to this document and any product described herein. Diodes Incorporated does not assume any liability arising out of the application or use of this document or any product described herein; neither does Diodes Incorporated convey any license under its patent or trademark rights, nor the rights of others. Any Customer or user of this document or products described herein in such applications shall assume all risks of such use and will agree to hold Diodes Incorporated and all the companies whose products are represented on Diodes Incorporated website, harmless against all damages.

Diodes Incorporated does not warrant or accept any liability whatsoever in respect of any products purchased through unauthorized sales channel. Should Customers purchase or use Diodes Incorporated products for any unintended or unauthorized application, Customers shall indemnify and hold Diodes Incorporated and its representatives harmless against all claims, damages, expenses, and attorney fees arising out of, directly or indirectly, any claim of personal injury or death associated with such unintended or unauthorized application.

Products described herein may be covered by one or more United States, international or foreign patents pending. Product names and markings noted herein may also be covered by one or more United States, international or foreign trademarks.

This document is written in English but may be translated into multiple languages for reference. Only the English version of this document is the final and determinative format released by Diodes Incorporated.

**LIFE SUPPORT**

Diodes Incorporated products are specifically not authorized for use as critical components in life support devices or systems without the express written approval of the Chief Executive Officer of Diodes Incorporated. As used herein:

A. Life support devices or systems are devices or systems which:

1. are intended to implant into the body, or
2. support or sustain life and whose failure to perform when properly used in accordance with instructions for use provided in the labeling can be reasonably expected to result in significant injury to the user.

B. A critical component is any component in a life support device or system whose failure to perform can be reasonably expected to cause the failure of the life support device or to affect its safety or effectiveness.

Customers represent that they have all necessary expertise in the safety and regulatory ramifications of their life support devices or systems, and acknowledge and agree that they are solely responsible for all legal, regulatory and safety-related requirements concerning their products and any use of Diodes Incorporated products in such safety-critical, life support devices or systems, notwithstanding any devices- or systems-related information or support that may be provided by Diodes Incorporated. Further, Customers must fully indemnify Diodes Incorporated and its representatives against any damages arising out of the use of Diodes Incorporated products in such safety-critical, life support devices or systems.

Copyright © 2015, Diodes Incorporated

[www.diodes.com](http://www.diodes.com)

# Mouser Electronics

Authorized Distributor

Click to View Pricing, Inventory, Delivery & Lifecycle Information:

[Diodes Incorporated:](#)

[ZXMN10B08E6TA](#)