

THIS DOCUMENT IS THE PROPERTY OF
KEYSTONE ELECTRONICS CORP. AND
SHALL NOT BE REPRODUCED, DISTRIBUTED
OR USED AS A BASIS FOR MANUFACTURE
WITHOUT PRIOR WRITTEN PERMISSION
FROM KEYSTONE ELECTRONICS CORP.

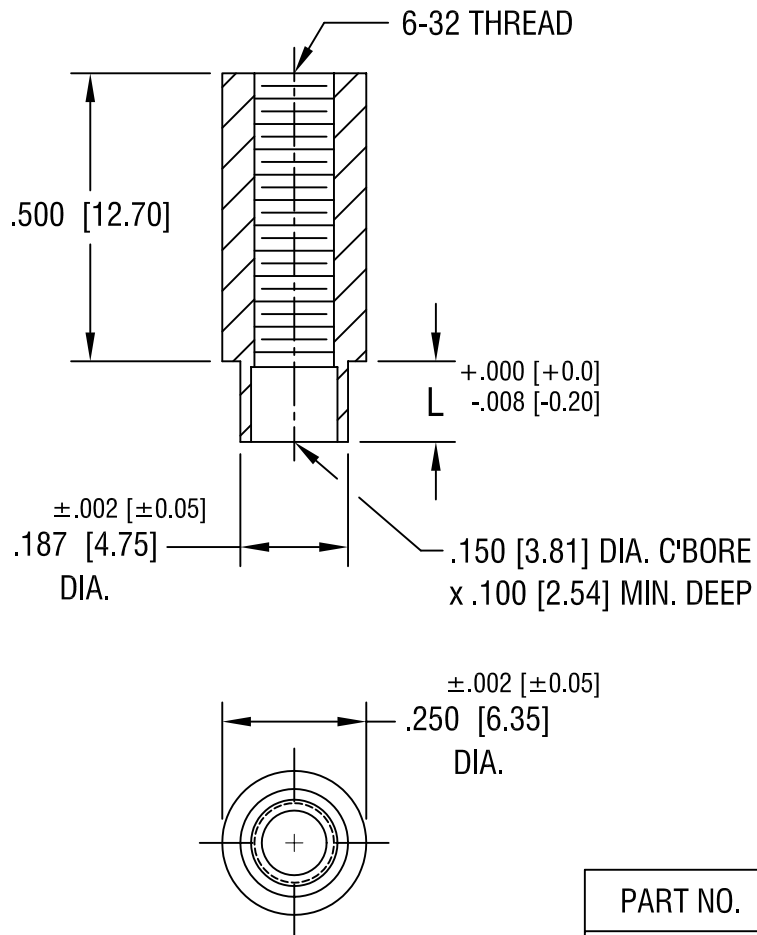

PART NO.	'L' DIM.
1604-2	.109 [2.77]
1604-3	.140 [3.56]
1604-4	.171 [4.34]

KEYSTONE ELECTRONICS CORP.			
ASTORIA, N.Y. 11105-2017			
PART NAME			
SWAGE THREADED STANDOFF			
MATERIAL			
BRASS			
FINISH		DRN BY	DATE
DUCTILE NICKEL PLATE		BOONE	9.6.96
		APPD	SCALE
		LN	3X
TOLERANCES	INCH [MM]	CODE	DWG NO.
DECIMAL	± .005 [± 0.15]	C/M	1604-
ANGULAR	± 1°		
UNLESS OTHERWISE SPECIFIED			

5.14.02	CHANGE AS PER ECN 02-044	A
DATE	DESCRIPTION	REV.

Mouser Electronics

Authorized Distributor

Click to View Pricing, Inventory, Delivery & Lifecycle Information:

[Keystone Electronics:](#)

[1604-2](#)