

# Features

# Switching Regulator

- Non-isolated
- Synchronous rectification design
- Adjustable output voltage
- 2, 3, 4Amp adjustable positive step down
- Integrated switching regulator
- Over load protection
- Continuous short circuit protection
- Efficiency up to 97%



## R-7xxxP\_D

**2,3,4 Amp  
SIP12  
Vertical &  
Horizontal  
Single Output**

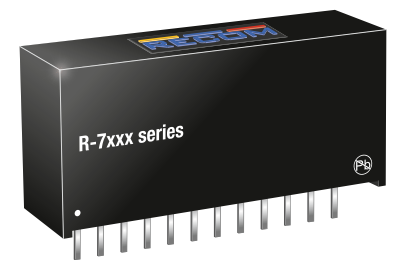

IEC/EN60950-1 certified

### Description

The R-7xxx series is a high performance 2.5V to 17V, 2Amp to 4Amp, 12-Pin SIP (single in-line package), integrated switching regulator (ISR). The synchronous - rectified design yields excellent efficiencies up to 97%. Short circuit protection reduces the short circuit input current to under 50mA.

### Selection Guide

Part Number	Input Voltage Range [VDC]	Output Voltage [VDC]	Vout Adjust Range <sup>(1)</sup> [VDC]	Output Current [A]	Efficiency @ min Vin [%]	Efficiency @ max. Vin [%]	Max. Capacitive Load <sup>(2)</sup> [µF]
R-723.3x	4.5 - 28	3.3	2.5 - 5.5	2	95	89	200/6800
R-725.0x	6.5 - 28	5.0	3.0 - 5.5	2	96	91	200/6800
R-726.5x	8.5 - 28	6.5	5.0 - 8.0	2	97	93	200/6800
R-729.0x	12 - 28	9.0	7.0 - 11	2	96	93	200/6800
R-7212x	15 - 28	12	10 - 14	2	97	95	200/6800
R-7215x	19 - 28	15	13 - 17	2	97	96	200/6800
R-733.3x	4.5 - 28	3.3	2.5 - 5.5	3	94	89	200/6800
R-735.0x	6.5 - 28	5.0	3.0 - 5.5	3	95	92	200/6800
R-736.5x	8.5 - 28	6.5	5.0 - 8.0	3	97	93	200/6800
R-739.0x	12 - 28	9.0	7.0 - 11	3	96	94	200/6800
R-7312x	15 - 28	12	10 - 14	3	97	96	200/6800
R-7315x	19 - 28	15	13 - 17	3	97	96	200/6800
R-743.3x	4.5 - 28	3.3	2.5 - 5.5	4	93	88	200/6800
R-745.0x	6.5 - 28	5.0	3.0 - 5.5	4	95	91	200/6800
R-746.5x	8.5 - 28	6.5	5.0 - 7.5	4	96	93	200/6800

#### Notes:

Note1: Vin-Vout ≥ 1.5V~4.0V depending on Vout if adjust function is used

Note2: Please refer to basic characteristics on page I-2

### Model Numbering

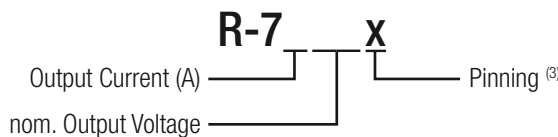

#### Notes:

Note3: x can be „P“ = vertical through hole

x can be „D“ = bent pins for horizontal through hole mounting

#### Ordering Examples:

R-723.3P    Iout= 2A    nom. Vout= 3.3VDC    P= vertical through hole  
 R-7312D    Iout= 3A    nom. Vout= 12VDC    D= horizontal through hole

**Specifications** (refer to standard application circuit, Ta= 25°C)

**BASIC CHARACTERISTICS**

Parameter	Condition	Min.	Typ.	Max.
Quiescent Current	min. Vin to max.			30mA
Internal Power Dissipation	ta<60°C			1.4W
Output Current Limit	R-72xxx		2.5A	3.0A
	R-73xxx		3.75A	4.25A
	R-74xxx		5.0A	5.5A
Minimum Load		10%		
ON/OFF CTRL <sup>(4)</sup>	DC-DC ON DC-DC OFF	Open or high, 4.5V min. / 28V max. Low (Power OFF) 0.8V max.		
Input Current of CTRL Pin	DC-DC OFF			100µA
Internal Operating Frequency		270kHz	300kHz	330kHz
Output Ripple and Noise			40mVp-p	70mVp-p
Maximum Capacitive Load	normal start-up time, no external diodes			200µF
	<1 second start-up time + diode protection circuit			6800µF

**Notes:**

Note4: ON/OFF pin driven by TTL (logic gate), open-collector bipolar transistor or open-drain MOSFET

**How to calculate the max output current**

The internal power dissipation (P<sub>D</sub>) follows the equation:

$$P_D = I_{out} \times V_{out} \times (1 - \text{Eff}_{\max Vin})$$

$$I_{out} = \frac{P_D}{V_{out} \times (1 - \text{Eff}_{\max Vin})}$$

Example: R-745.0P

**Calculation 1:**

V<sub>in</sub> = 28V

V<sub>out</sub> = 5V

Eff<sub>max Vin</sub> = 91%

P<sub>D</sub> = 1.4W

T<sub>Ambient</sub> = 60°C

$$I_{out} = \frac{1.4W}{5V \times (1 - 0.91)} = 3.11A$$

**Calculation 2:**

V<sub>in</sub> = 28V

V<sub>out</sub> = 5V

Eff<sub>max Vin</sub> = 91%

P<sub>D</sub> = 1.0W

T<sub>Ambient</sub> = 85°C

$$I_{out} = \frac{1W}{5V \times (1 - 0.91)} = 2.222A$$

**Calculation 3:**

V<sub>in</sub> = 12V

Eff<sub>max Vin</sub> = 94%

P<sub>D</sub> = 1.0W

T<sub>Ambient</sub> = 85°C

$$I_{out} = \frac{1W}{5V \times (1 - 0.94)} = 3.33A$$

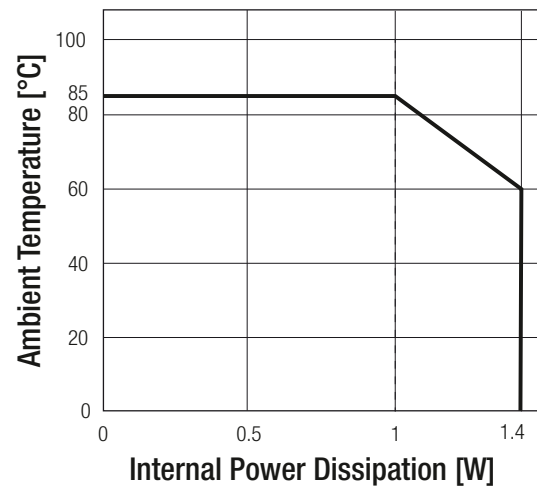

continued on next page

**Specifications** (refer to standard application circuit, Ta= 25°C)

Efficiency vs. Load

R-72xx / R-73xx / R-74xx  
max. Vin

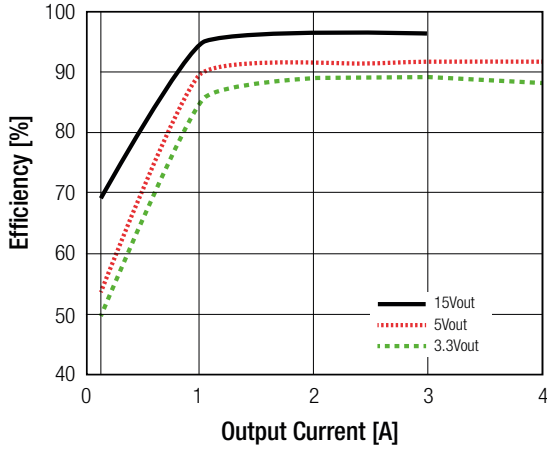

R-72xx / R-73xx / R-74xx  
min. Vin

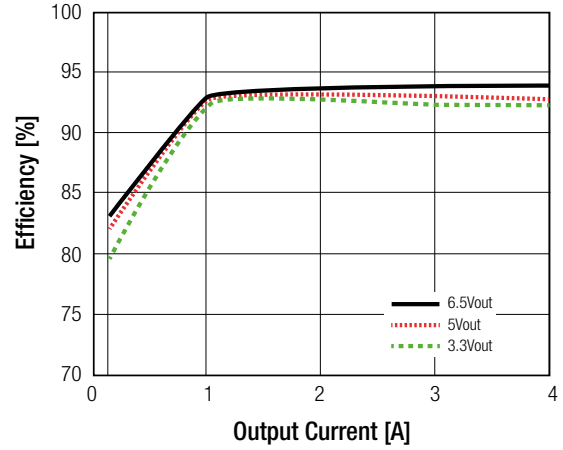

Efficiency vs. Input Voltage

R-72xx / R-73xx

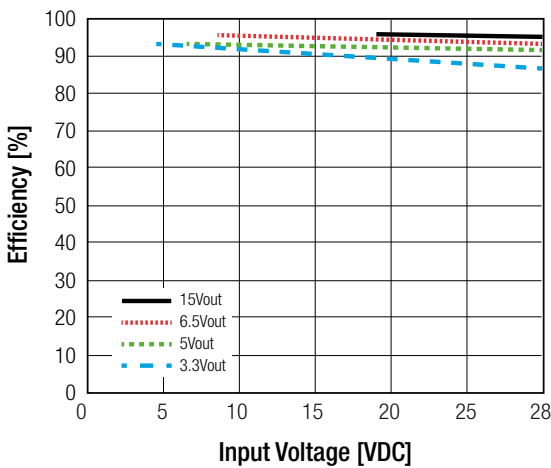

R-74xx

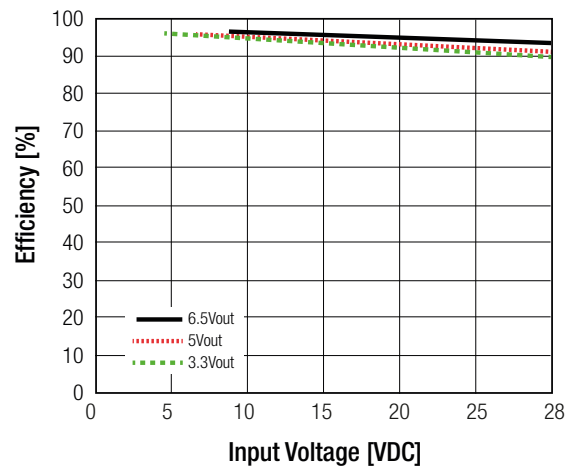

Ripple vs. Input Voltage

R-72xx / R-73xx

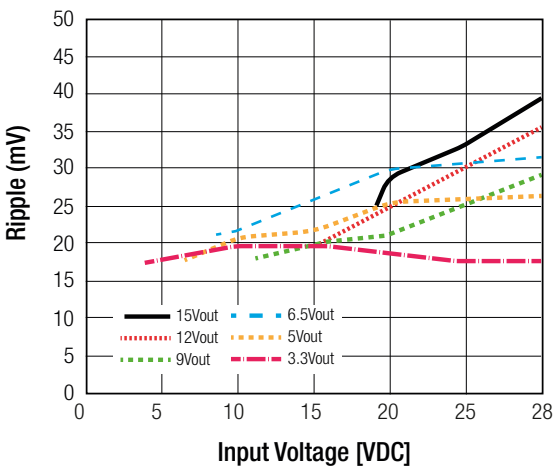

R-74xx

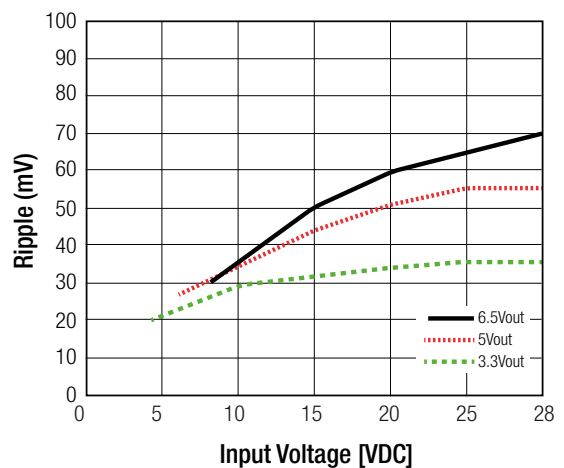

**Specifications** (refer to standard application circuit, Ta= 25°C)

**Trim Table**

2ADC	R-723.3P/D	R-725.0P/D	R-726.5P/D	R-729.0P/D	R-7212P/D	R-7215P/D
3ADC	R-733.3P/D	R-735.0P/D	R-736.5P/D	R-739.0P/D	R-7312P/D	R-7315P/D
4ADC	R-743.3P/D	R-745.0P/D	R-746.5P/D			

Vout nom.	3.3VDC		5.0VDC		6.5VDC		9.0VDC		12VDC		15VDC	
Vout adj.	R1	R2	R1	R2	R1	R2	R1	R2	R1	R2	R1	R2
2.5	8.5kΩ											
3.0	33kΩ		470kΩ									
3.2	110kΩ		1.6kΩ									
3.3			2.2kΩ									
3.4		36kΩ	3.0kΩ									
3.6		11kΩ	4.7kΩ									
3.9		4.7kΩ	8.5kΩ									
4.5		1.6kΩ	30kΩ									
4.9		820Ω	220kΩ									
5.0		680Ω			11kΩ							
5.1		560Ω		28kΩ	12kΩ							
5.5		190Ω		2.6kΩ	20kΩ							
6.0					47kΩ							
6.5												
7.0						4.5kΩ	13kΩ					
7.5						2.2kΩ						
8.0							31kΩ					
9.0												
10								2.2kΩ	20kΩ			
11								390Ω	47kΩ			
12												
13										2.4kΩ	36kΩ	
14										390Ω	76kΩ	
15												
16												2.6kΩ
17												860Ω

**REGULATIONS**

Parameter	Condition	Value
Output Accuracy	full load	±1.0% typ. / ±2.0% max.
Line Regulation	low line to high line, full load	± 0.5% typ. / ±1.0% max.
Load Regulation <sup>(6)</sup>	10% to 100%, full load	± 0.5% typ. / ±1.0% max.
Transient Response <sup>(6)</sup>	50% load step change Vout Over / Undershoot	100µs typ. / 200µs max. 100mV max.

**Notes:**

Note5: Operation below 10% load will not harm the converter, but specifications may not be met

Note6: Requires a 100µF electrolytic or tantalum output capacitor for proper operation in all applications (the capacitor has to be placed as close as possible to the output pins)

**Specifications** (refer to standard application circuit, Ta= 25°C)

**PROTECTIONS**

Parameter	Condition	Value
Short Circuit Protection (SCP)		continuous, automatic recovery
Short Circuit Input Current		50mA typ. / 100mA max.

**Optional Diode Protection Circuit**

Add a blocking diode to Vout if current can flow backwards into the output, as this can damage the converter when it is powered down. Protection diodes are required for high capacitive loads.

The diode can either be fitted across the device, if the source is low impedance or fitted in series with the output (recommended).

**Optional Protection 1:**

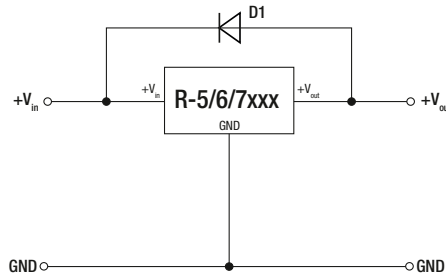

**Optional Protection :**

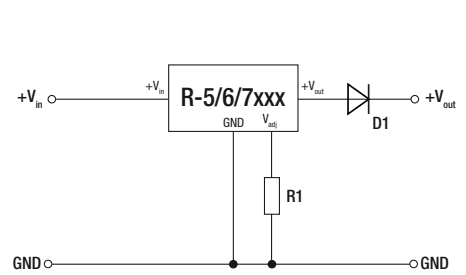

R1: Trim output voltage up to 1 diode drop

**ENVIRONMENTAL**

Parameter	Condition	Value
Operating Temperature Range	without derating @ natural convection 0.1m/s	-40°C to +85°C
Maximum Case Temperature		+110°C
Thermal Impedance	@ natural convection 0.1m/s	25°C/W
Operating Humidity	non-condensing	95% RH max.
Operating Altitude		2000m
Pollution Degree		PD2
MTBF	according to MIL-HDBK 217F, G.B.	+25°C +85°C 749 x 10 <sup>3</sup> hours 150 x 10 <sup>3</sup> hours

**SAFETY AND CERTIFICATIONS**

Certificate Type (Safety)	Report / File Number	Standard
Information Technology Equipment, General Requirements for Safety	1605077-12	IEC60950-1:2005, 2nd Edition + AM2:2013 EN60950-1:2006 + AM2:2013
EAC	RU-AT.49.09571	TP TC 004/2011
RoHS 2+		RoHS-2011/65/EU + AM-2015/863

continued on next page

**Specifications** (refer to standard application circuit, Ta= 25°C)

**EMC Filtering Suggestions according to EN55032**

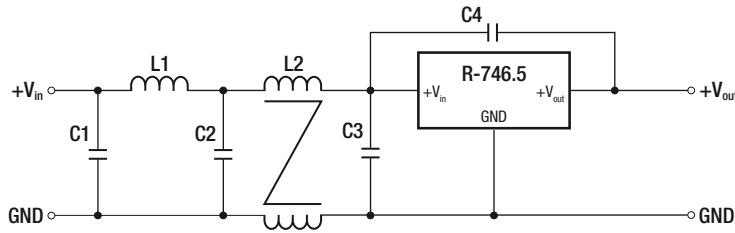

**Component List**

EN55022	C1	C2	C3	C4	L1	L2
Class A	N/A	33 $\mu$ F	N/A	N/A	N/A	0.45mH CMC
Class B	10 $\mu$ F	33 $\mu$ F	1nF/2kV	2mH	0.45mH CMC	

**DIMENSION AND PHYSICAL CHARACTERISTICS**

Parameter	Type	Value
Material	case potting	non-conductive black plastic, (UL94 V-0) epoxy, (UL94 V-0)
Dimension (LxWxH)		32.2 x 9.1 x 15.0mm
Weight		9g typ.

**Dimension Drawing (mm)**

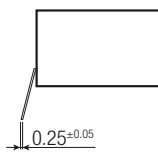
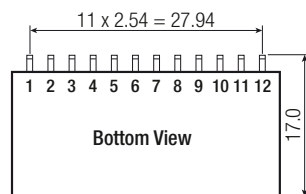
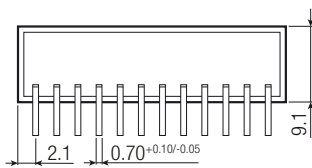
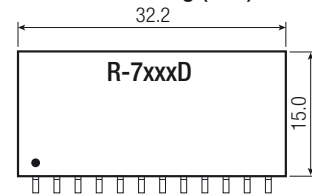

**Recommended Footprint Details**

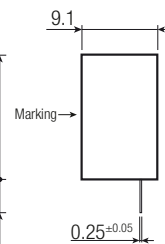
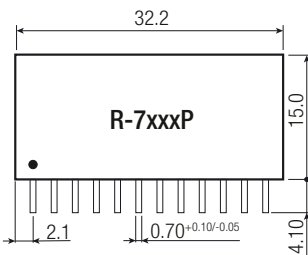
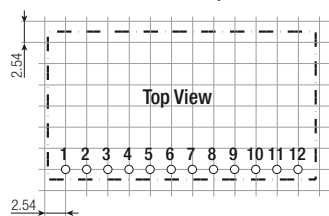

**Recommended Footprint Details**

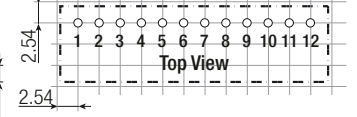
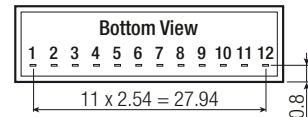

**Pin Connections**

Pin #	Single	Description
1	ON/OFF	Input pin: Active low (less than 0.8V) to disable the device
2,3,4	Vin	Power Input
5, 6, 7, 8	GND	Input and Output ground (common)
9, 10, 11	Vout	Power output
12	Vadj	with external resistors R1, R2 to selected output voltage

Tolerance: xx.x= ±0.5mm  
xx.xx= ±0.25mm

**Specifications** (refer to standard application circuit, Ta= 25°C)

**INSTALLATION AND APPLICATION**

**Standard Application Circuit**

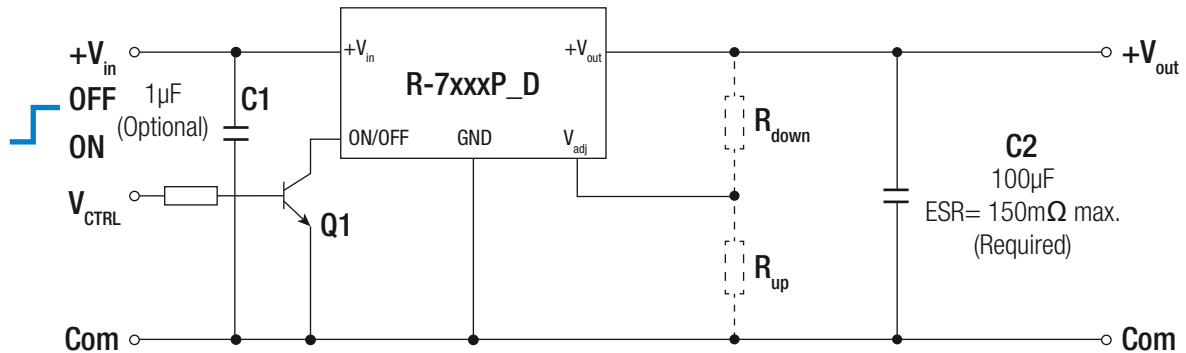

Add blocking diode to Vout if current can flow backwards into the output, as this can damage the converter.  
(Please refer to "Optional Diode Protection Circuit" on Page I-5)

**PACKAGING INFORMATION**

Parameter	Type	Value
Packaging Dimensions (LxWxH)	R-7xxxD	520.0 x 20.0 x 19.0mm
	R-7xxxP	530.0 x 23.0 x 19.0mm
Packaging Quantity	tube	15pcs
Storage Temperature Range		-40°C to +125°C

The product information and specifications may be subject to changes even without prior written notice. The product has been designed for various applications; its suitability lies in the responsibility of each customer. The products are not authorized for use in safety-critical applications without RECOM's explicit written consent. A safety-critical application is an application where a failure may reasonably be expected to endanger or cause loss of life, inflict bodily harm or damage property. The applicant shall indemnify and hold harmless RECOM, its affiliated companies and its representatives against any damage claims in connection with the unauthorized use of RECOM products in such safety-critical applications.

# Mouser Electronics

Authorized Distributor

Click to View Pricing, Inventory, Delivery & Lifecycle Information:

## RECOM:

[R-743.3P](#) [R-745.0P](#) [R-746.5P](#) [R-7212D](#) [R-7212P](#) [R-7215D](#) [R-7215P](#) [R-723.3D](#) [R-723.3P](#) [R-725.0D](#) [R-725.0P](#)  
[R-726.5D](#) [R-726.5P](#) [R-729.0D](#) [R-729.0P](#) [R-7312D](#) [R-7312P](#) [R-7315D](#) [R-7315P](#) [R-733.3D](#) [R-733.3P](#) [R-735.0D](#)  
[R-735.0P](#) [R-736.5D](#) [R-736.5P](#) [R-739.0D](#) [R-739.0P](#) [R-743.3D](#) [R-745.0D](#) [R-746.5D](#)