

THIS DRAWING IS UNPUBLISHED. RELEASED FOR PUBLICATION

© COPYRIGHT - By - ALL RIGHTS RESERVED.

LOC FT DIST 0

REVISIONS

P	LTR	DESCRIPTION	DATE	DWN	APVD
	F3	REVISED PER ECO-13-015432	01OCT2013	KH	MM

MATERIALS:
 HOUSING: POLYAMIDE, UL94V-0, BLACK.
 TERMINALS: COPPER ALLOY, TIN PLATED.
 SCREWS: STEEL, ZINC PLATED.

ELECTRICAL:
 RATING: 20A, UL & CSA.

MECHANICAL:
 WIRE RANGE: 12-22 AWG.
 MAXIMUM TIGHTENING TORQUE: 7 IN-LBS.

ENVIRONMENTAL:
 CONTINUOUS OPERATING TEMP.: -40°C TO +105°C.

- 1 PRELIMINARY PART NUMBER.
- 2 SCREWS ARE BOTTOMED, NO THREAD INTERRUPT.
- 3 OBSOLETE PART NUMBER.
- 4 CAPTIVE SCREWS BACKED OUT TO 1.3 IN-LB TORQUE.
- 5 OBSOLETE PARTS: OBSOLETE CIS STREAMLINING PER D.RENAUD/D.SINISI
- 6 SCREWS ARE NICKEL PLATED BRASS

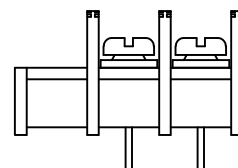
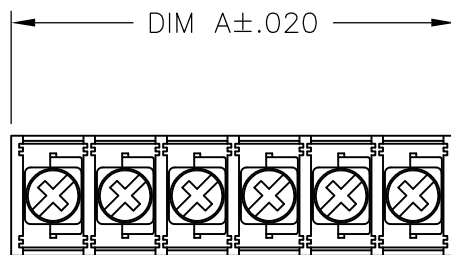

5 OBSOLETE ~~796922-6~~

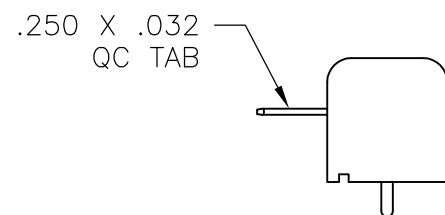
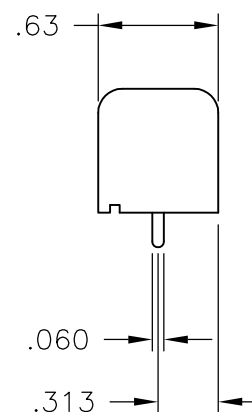
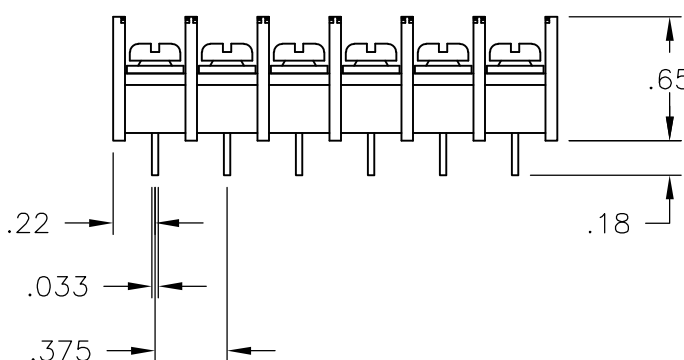

5 OBSOLETE ~~796922-7~~

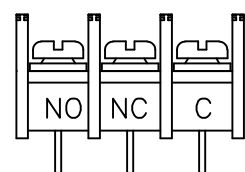

1-796922-8

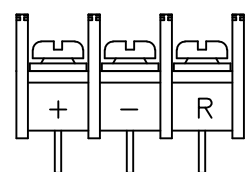

1-796922-9

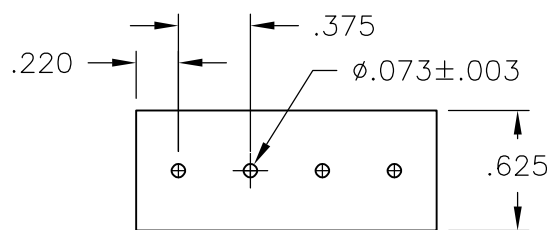

RECOMMENDED PCB LAYOUT

DIM A	NO OF POS	CATALOG NUMBER	PART NUMBER
6.436	17	NC6-P108-17	5-1437664-2
6.061	16	NC6-P108-16	5-1437664-1
5.686	15	NC6-P108-15	5-1437664-0
5.311	14	NC6-P108-14	4-1437664-9
4.936	13	NC6-P108-13	4-1437664-8
4.561	12	NC6-P108-12	4-1437664-7
4.186	11	NC6-P108-11	4-1437664-6
3.811	10	NC6-P108-10-068	1-796922-5
3.811	10	NC6-P108-10	4-1437664-4
3.436	9	NC6-P108-09-067	1-796922-4
3.436	9	NC6-P108-09	4-1437664-2
3.061	8	NC6-P108-08-069	1-796922-7
3.061	8	NC6-P108-08-066	1-796922-3
3.061	8	NC6-P108-08	4-1437664-1
2.686	7	NC6-P108-07-065	1-796922-2
2.686	7	NC6-P108-07-057	796922-7
2.686	7	NC6-P108-07	4-1437664-0
2.311	6	NC6-P108-06-064	1-796922-1
2.311	6	NC6-P108-06-054	796922-3
2.311	6	NC6-P108-06-049	3-1437664-9
2.311	6	NC6-P108-06	3-1437664-8
1.936	5	NC6-P108-05-063	1-796922-0
1.936	5	NC6-P108-05-052	3-1437664-7
1.936	5	NC6-P108-05	3-1437664-5
1.561	4	NC6-P106-04	6-1437664-2
1.561	4	NC6-P108-04-062	796922-9
1.561	4	NC6-P108-04	3-1437664-3
1.186	3	NC6-P108-03-289	1-796922-9
1.186	3	NC6-P108-03-290	1-796922-8
1.186	3	NC6-P108-03-056	796922-6
1.186	3	NC6-P108-03-501	1-796922-6
1.186	3	NC6-P108-03	3-1437664-1
.811	2	NC6-P108-02-061	796922-8
.811	2	NC6-P108-02	3-1437664-0

THIS DRAWING IS A CONTROLLED DOCUMENT.

DWN S SCHLEGEL 03JUN03	 TE Connectivity NAME NC6-P108-XX ASSEMBLY			
CHK H WAKEEM 6/3/03				
APVD H WAKEEM 6/3/03				
PRODUCT SPEC				
APPLICATION SPEC	SIZE A3	CAGE CODE 00779	DRAWING NO C-3-1437664-0	RESTRICTED TO
MATERIAL	WEIGHT	CUSTOMER DRAWING		SCALE NTS
DIMENSIONS: INCHES TOLERANCES UNLESS OTHERWISE SPECIFIED: 0 PLC ± - 1 PLC ± - 2 PLC ± .01 3 PLC ± .005 4 PLC ± - ANGLES ± -		SHEET 1 OF 2 REV F3		

THIS DRAWING IS UNPUBLISHED. RELEASED FOR PUBLICATION
 © COPYRIGHT - By - ALL RIGHTS RESERVED.

LOC	DIST	REVISIONS			
P	LTR	DESCRIPTION	DATE	DWN	APVD
FT	0	-	SEE SHEET 1	-	-

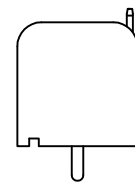
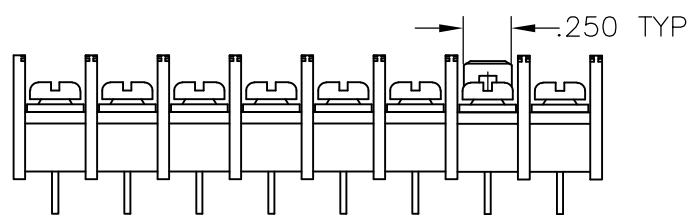
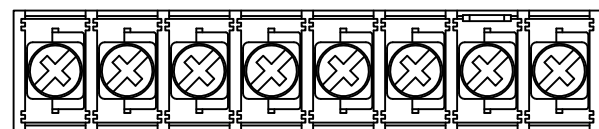

1-796922-7

9.061	24	NC6-P108-24	5-1437664-7
8.686	23	NC6-P108-23	796922-5
8.311	22	NC6-P108-22	5-1437664-6
7.936	21	NC6-P108-21	796922-4
7.561	20	NC6-P108-20	5-1437664-5
7.186	19	NC6-P108-19	5-1437664-4
6.811	18	NC6-P108-18	5-1437664-3
DIM A	NO OF POS	CATALOG NUMBER	PART NUMBER

THIS DRAWING IS A CONTROLLED DOCUMENT.		DWN S SCHLEGEL 03JUN03	STE TE Connectivity				
DIMENSIONS: INCHES		CHK H WAKEEM 6/3/03					
TOLERANCES UNLESS OTHERWISE SPECIFIED:		APVD H WAKEEM 6/3/03	NAME				
0 PLC ± - 1 PLC ± - 2 PLC ± .01 3 PLC ± .005 4 PLC ± - ANGLES ± -		PRODUCT SPEC -	NC6-P108-XX ASSEMBLY				
MATERIAL -		APPLICATION SPEC -	SIZE A3	CAGE CODE 00779	DRAWING NO C-3-1437664-0	RESTRICTED TO -	
FINISH -		WEIGHT -	CUSTOMER DRAWING		SCALE NTS	SHEET 2 OF 2	REV F3

Mouser Electronics

Authorized Distributor

Click to View Pricing, Inventory, Delivery & Lifecycle Information:

[TE Connectivity:](#)

[NC6-P108-03](#)