

DESCRIPTION: DIP SOLDER FEMALE/STAMPED

SPECIFICATIONS:

MATERIALS:

SHELL: STEEL, NICKEL PLATED
 INSULATOR: UL 94V-0 RATED PA6T
 CONTACTS: BRASS, GOLD PLATED
 RoHS COMPLIANT

ELECTRICALS:

CURRENT RATING: 5 AMPS
 CONTACT RESISTANCE: 15 mOHMS MAX
 INSULATOR RESISTANCE: 1000 MOHMS MIN
 VOLTAGE: 500V AC FOR 1 MINUTE
 TEMPERATURE: -55°C TO +125°C

POS.	A	B	C	D	E	F	G
09	1.213	0.984	0.642	0.756	0.311	0.109	0.496
	30.80	24.99	16.30	19.20	7.90	2.77	12.60
15	1.541	1.312	0.971	1.091	0.311	0.109	0.496
	39.15	33.32	24.65	27.70	7.90	2.77	12.60
25	2.087	1.852	1.512	1.618	0.311	0.109	0.496
	53.00	47.04	38.40	41.10	7.90	2.77	12.60
37	2.728	2.500	2.157	2.256	0.311	0.109	0.496
	69.30	63.50	54.80	57.30	7.90	2.77	12.60
50	2.638	2.406	2.055	2.169	0.429	0.109	0.602
	67.00	61.00	52.20	55.10	10.90	2.77	15.30

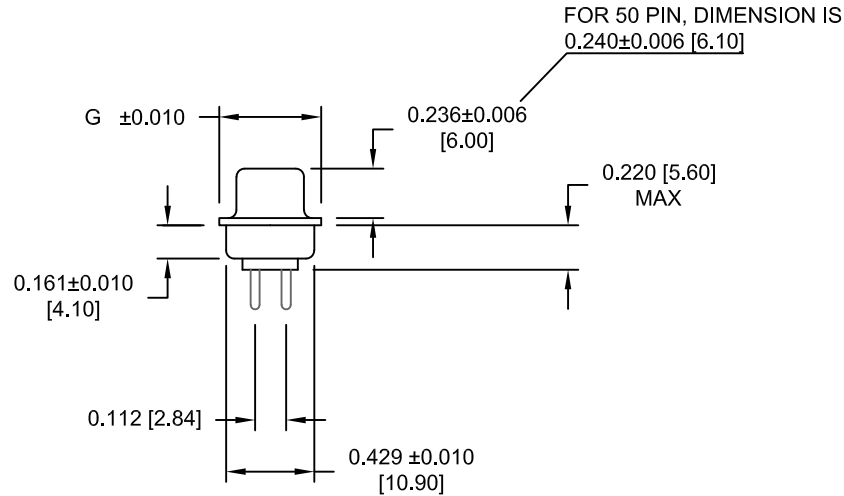
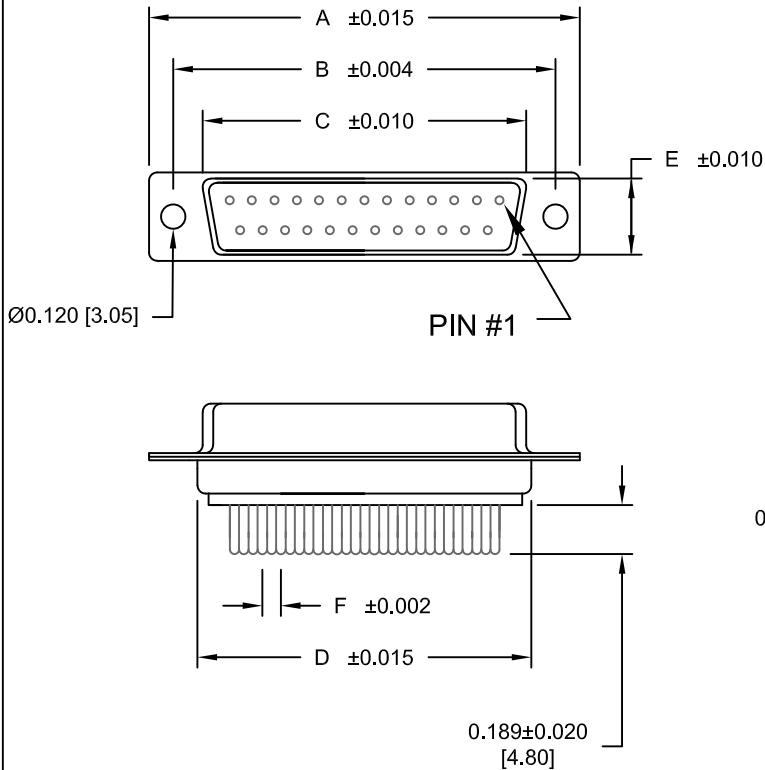

171-YYY-213RYY1

SERIES _____

POSITIONS _____

009 _____

015 _____

025 _____

037 _____

050 _____

GENDER _____

1 = MALE

2 = FEMALE

TERMINATION _____

1 = DIP SOLDER

SHELL PLATING _____

3 = NICKEL

HARDWARE OPTIONS _____

00 = NO HARDWARE

01 = .098" 4-40 CLINCH NUT BOARD SIDE

02 = .236" 4-40 CLINCH NUT BOARD SIDE

03 = .236" 4-40 CLINCH NUT MATING SIDE

05 = .237" 4-40 BOARD LOCK

08 = .228" 4-40 BOARD LOCK

90 = .237" 4-40 BOARD LOCK

FOR 0.093" BOARD

91 = .237" 4-40 SPACER/BOARD LOCK

92 = .237" 4-40 SPACER/BOARD LOCK

FOR 0.093" BOARD

PLATING OPTIONS _____

1 = GOLD FLASH

2 = 30 MICRO-INCH GOLD

DO NOT SCALE FROM DRAWING

	THESE DRAWINGS AND SPECIFICATIONS ARE THE PROPERTY OF NorComp AND SHALL NOT BE REPRODUCED, COPIED OR USED AS THE BASIS FOR THE MANUFACTURE OF SALE OF APPARATUS WITHOUT WRITTEN PERMISSION.		DRAWN: PAM JENKINS	DATE: 8-12-98
	NorComp		SCALE: NTS	SHEET 1 OF 3
DWG NO. 171-YYY-213RYY1				

RoHS COMPLIANT

DESCRIPTION: PCB LAYOUT - STANDARD "D" - MALE & FEMALE

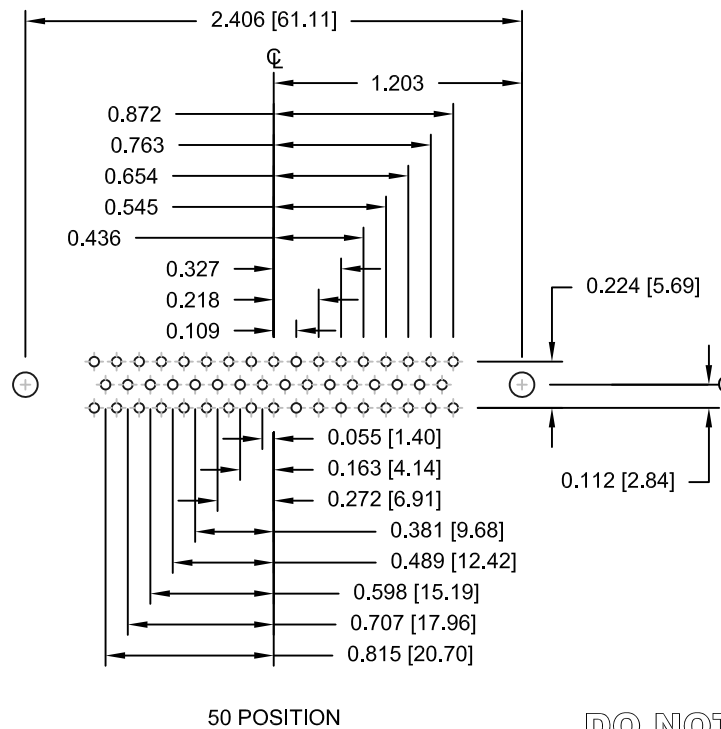
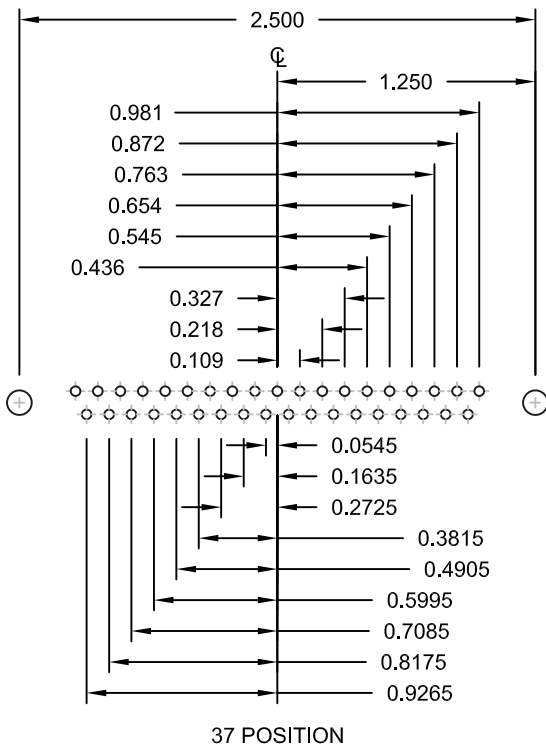
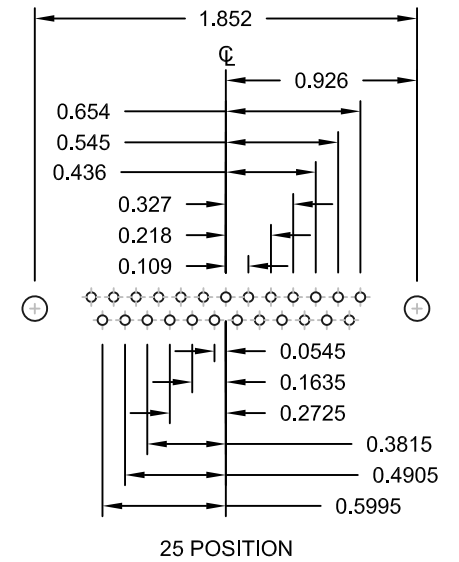
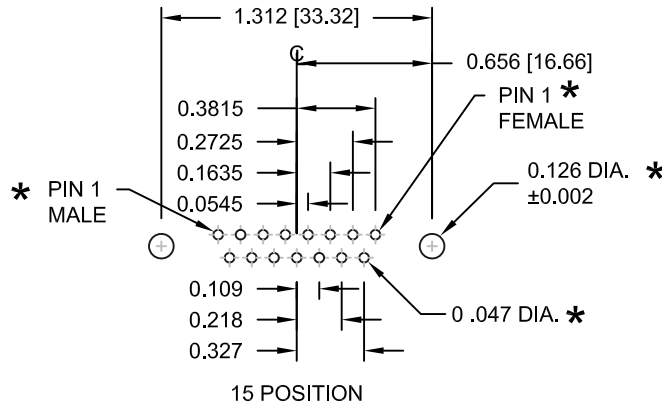
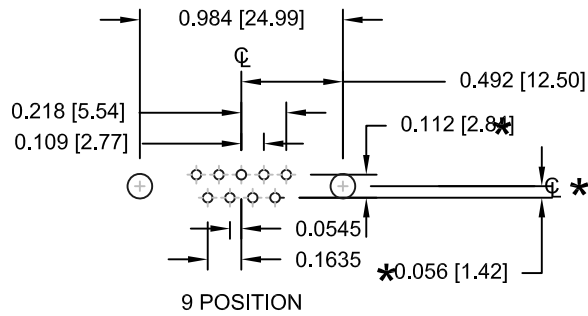

* TYP. ON ALL SIZES

DO NOT SCALE FROM DRAWING

	THESE DRAWINGS AND SPECIFICATIONS ARE THE PROPERTY OF NorComp AND SHALL NOT BE REPRODUCED, COPIED OR USED AS THE BASIS FOR THE MANUFACTURE OF SALE OF APPARATUS WITHOUT WRITTEN PERMISSION.		DRAWN: PAM JENKINS	DATE: 8-12-98
	NorComp		SCALE: NTS	SHEET 2 OF 3
DWG NO. 171-YYY-213RYY1				

DESCRIPTION: CLINCH NUT HARDWARE

ALL CLINCH-NUTS ARE 4-40 INTERNAL THREADS

TOLERANCE:
ALL DIMENSIONS ARE ±0.010

01X 0.098" (BOARD SIDE)

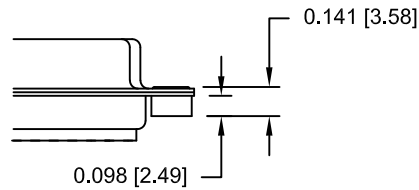

02X 0.236" (BOARD SIDE)

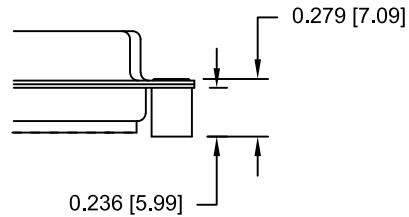

03X..... 0.236" (MATING SIDE)

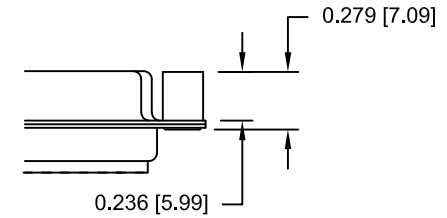

05X 0.237" (BOARD SIDE)

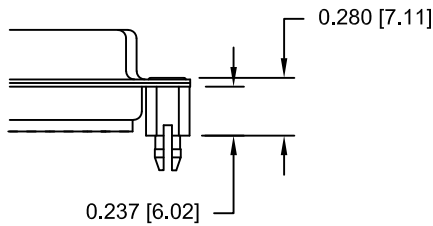

08X 0.228" (BOARD SIDE)

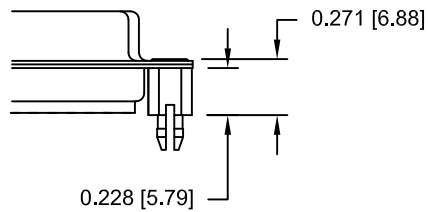

91X 0.237" BOARD SIDE
0.197 MATING SIDE

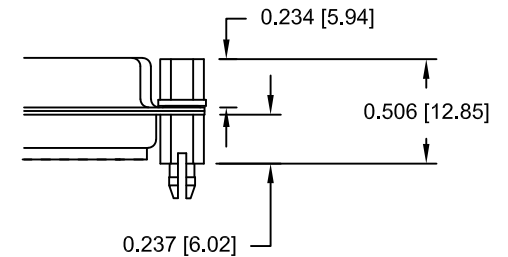

90X 0.237" (BOARD SIDE)

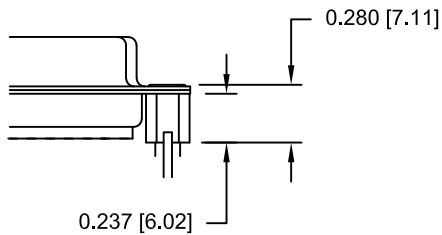

92X 0.237" BOARD SIDE
0.197 MATING SIDE

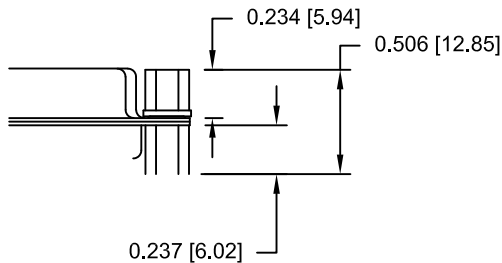

NOTE: 4-40 FEMALE SCREW LOCK IS REMOVABLE

NOTE: 90 & 92 OPTION FOR 0.093" MAX. BOARD THICKNESS

DO NOT SCALE FROM DRAWING



THESE DRAWINGS AND SPECIFICATIONS ARE THE PROPERTY OF NorComp AND SHALL NOT BE REPRODUCED, COPIED OR USED AS THE BASIS FOR THE MANUFACTURE OF SALE OF APPARATUS WITHOUT WRITTEN PERMISSION.

DRAWN: PAM JENKINS		DATE: 8-12-98	
SCALE: NTS	SHEET 3	OF 3	REV 12
DWG NO. 171-YYY-213RY1			

RoHS COMPLIANT

NorComp

Mouser Electronics

Authorized Distributor

Click to View Pricing, Inventory, Delivery & Lifecycle Information:

NorComp:

[171-015-213R031](#) [171-025-213R031](#) [171-009-213R011](#) [171-009-213R021](#) [171-009-213R031](#) [171-009-213R911](#)
[171-015-213R011](#) [171-015-213R021](#) [171-025-213R011](#) [171-025-213R021](#) [171-025-213R911](#) [171-037-213R011](#)
[171-037-213R021](#) [171-037-213R031](#) [171-037-213R911](#) [171-050-213R011](#) [171-050-213R021](#) [171-050-213R031](#)
[171-050-213R911](#) [171-015-213R911](#) [171-050-213R051](#)