

SCHOTTKY BARRIER RECTIFIER

VOLTAGE RANGE 20 to 200 Volts CURRENT 16.0 Ampere

FEATURES

- * Low switching noise
- * Low forward voltage drop
- * Low thermal resistance
- * High current capability
- * High switching capability
- * High surge capability
- * High reliability

MECHANICAL DATA

- * Case: To-220 molded plastic
- * Epoxy: Device has UL flammability classification 94V-0
- * Lead: MIL-STD-202E method 208C guaranteed
- * Mounting position: Any
- * Weight: 2.24 grams



TO-220

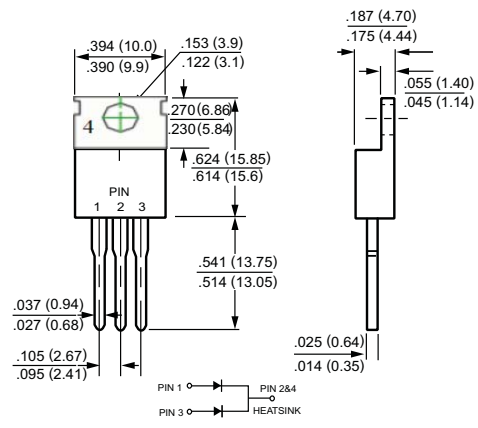

Dimensions in inches and (millimeters)

MAXIMUM RATINGS AND ELECTRICAL CHARACTERISTICS

Ratings at 25 °C ambient temperature unless otherwise specified.
Single phase, half wave, 60 Hz, resistive or inductive load.
For capacitive load, derate current by 20%.

MAXIMUM RATINGS (@ TA=25 °C unless otherwise noted)

RATINGS	SYMBOL	SR1620C	SR1630C	SR1635C	SR1640C	SR1645C	SR1650C	SR1660C	SR1680C	SR16100C	SR16150C	SR16200C	UNITS
Maximum Recurrent Peak Reverse Voltage	V_{RRM}	20	30	35	40	45	50	60	80	100	150	200	Volts
Maximum RMS Voltage	V_{RMS}	14	21	25	28	32	35	42	56	70	105	140	Volts
Maximum DC Blocking Voltage	V_{DC}	20	30	35	40	45	50	60	80	100	150	200	Volts
Maximum Average Forward Rectified Current at Derating Case Temperature	I_O	16.0											Amps
Peak Forward Surge Current 8.3 ms single half sine-wave superimposed on rated load (JEDEC method)	I_{FSM}	150											Amps
Typical Current Squared Time	I^2t	93.37											A ² /Sec
Typical Thermal Resistance (Note 1)	$R_{\theta JC}$	2.0											°C/W
	$R_{\theta JA}$	40											
Typical Junction Capacitance (Note 3)	C_J	700					500						pF
Operating Temperature Range	T_J	150											°C
Storage Temperature Range	T_{STG}	-55 to + 150											°C

ELECTRICAL CHARACTERISTICS (@TA=25 °C unless otherwise noted)

CHARACTERISTICS	SYMBOL	SR1620C	SR1630C	SR1635C	SR1640C	SR1645C	SR1650C	SR1660C	SR1680C	SR16100C	SR16150C	SR16200C	UNITS	
Maximum Instantaneous Forward Voltage at 8.0A DC	V_F	.65					.75			.85				Volts
Maximum Average Reverse Current at Rated DC Blocking Voltage	I_R	@ $T_A = 25^\circ C$											mA	
		@ $T_A = 100^\circ C$											2	mA

- NOTES : 1. Thermal Resistance : Heat-sink mounted.
2. Suffix "A" = Common Anode.
3. Measured at 1 MHz and applied reverse voltage of 4.0 volts.
4. "Fully ROHS compliant", "100% Sn plating (Pb-free)".

RATING AND CHARACTERISTICS CURVES (SR1620C THRU SR16200C)

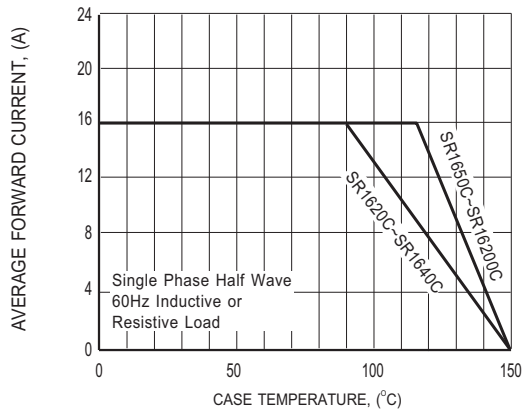

FIG.1 TYPICAL FORWARD CURRENT DERATING CURVE

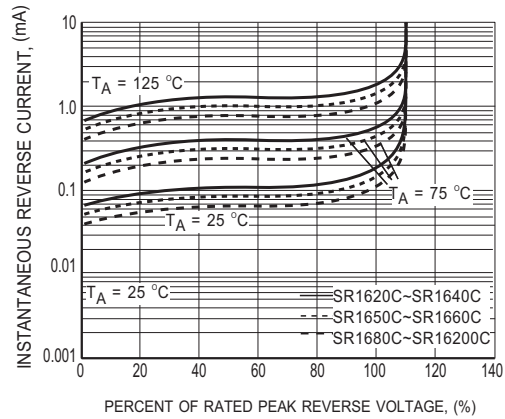

FIG.2 TYPICAL REVERSE CHARACTERISTICS

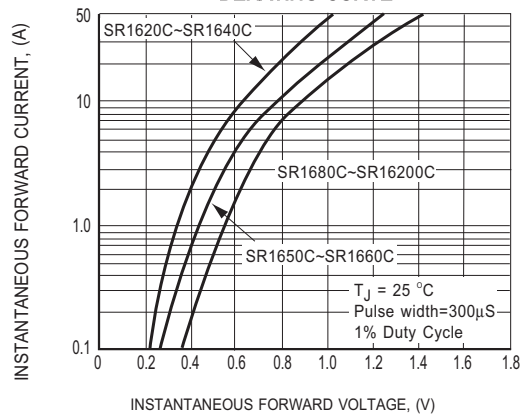

FIG.3 TYPICAL INSTANTANEOUS FORWARD CHARACTERISTICS

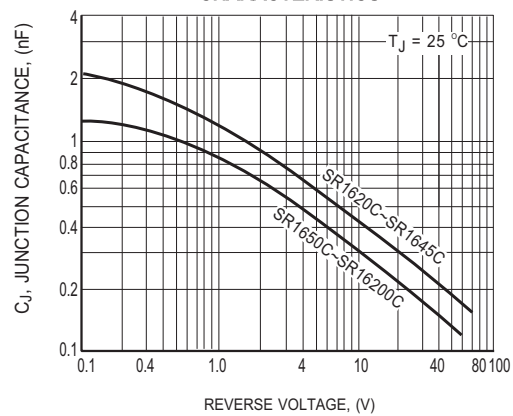

FIG.4 TYPICAL JUNCTION CAPACITANCE

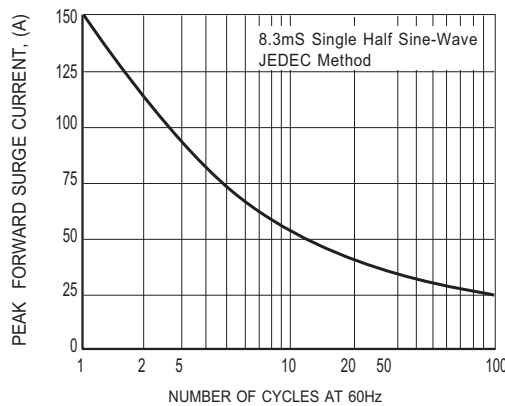

FIG.5 MAXIMUM NON-REPETITIVE FORWARD SURGE CURRENT



Attachment information about SR16XXC

1. Internal Circuit



2. Marking on the body

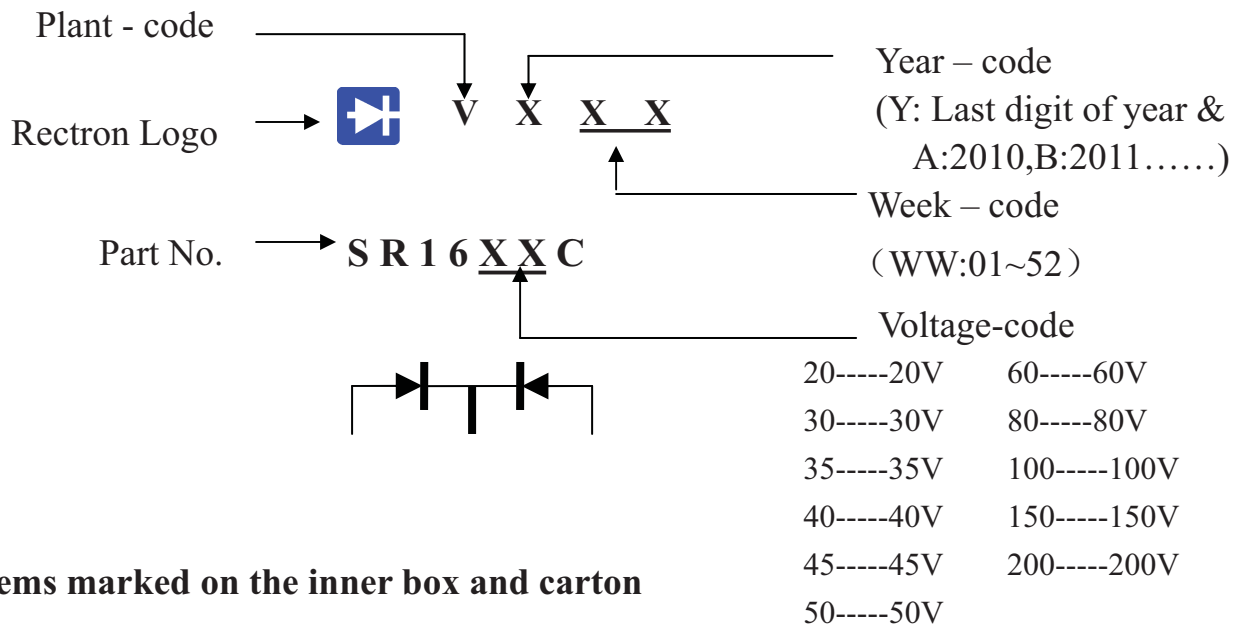

3. Items marked on the inner box and carton

3.1 On the box (for -C)

CUSTOMER
TYPE
LOT NO.
QUANTITY
Q.A.
DATE

3.2 On the carton

CUSTOMER
TYPE
QUANTITY
LOT NO.
REMARK

PACKAGING OF DIODE AND BRIDGE RECTIFIERS

TUBE PACK

PACKAGE	PACKING CODE	EA PER BOX	INNER BOX SIZE (mm)	CARTON SIZE (mm)	EA PER CARTON	WEIGHT(Kg)
(I)TO-220/TO-220(A)	-C	2,000	550*140*92	572*308*120	4,000	11.80

DISCLAIMER NOTICE

Rectron Inc reserves the right to make changes without notice to any product specification herein, to make corrections, modifications, enhancements or other changes. Rectron Inc or anyone on its behalf assumes no responsibility or liability for any errors or inaccuracies. Data sheet specifications and its information contained are intended to provide a product description only. "Typical" parameters which may be included on RECTRON data sheets and/ or specifications can and do vary in different applications and actual performance may vary over time. Rectron Inc does not assume any liability arising out of the application or use of any product or circuit.

Rectron products are not designed, intended or authorized for use in medical, life-saving implant or other applications intended for life-sustaining or other related applications where a failure or malfunction of component or circuitry may directly or indirectly cause injury or threaten a life without expressed written approval of Rectron Inc. Customers using or selling Rectron components for use in such applications do so at their own risk and shall agree to fully indemnify Rectron Inc and its subsidiaries harmless against all claims, damages and expenditures.

Mouser Electronics

Authorized Distributor

Click to View Pricing, Inventory, Delivery & Lifecycle Information:

[Rectron:](#)

[SR1630C](#) [SR1635C](#) [SR1660C](#) [SR1645C](#) [SR1640C](#) [SR1650C](#) [SR1620C](#)