

KSA & KSL Series Sealed Tact Switch



Features/Benefits

- Designed for automatic or manual insertion
- Cambered terminals to ensure self retention
- Top or side actuated
- Large choice of caps
- RoHS compliant and compatible

Typical Applications

- Automotive
- Industrial
- Telecommunication networks

Tactile Switches

B

Specification

CONTACT ARRANGEMENT: SPST, N.O.
 DOUBLE OVERMOLDING ON TERMINAL
 SEALING: IP60
 TERMINALS: PC pins, ground pin optional

Mechanical

Type	Actuation force N	Operating life (operations)	Travel to make
KSA0M211	1,4 ± 0,4	100,000	0,5 ± 0,2
KSA0M311	1,4 ± 0,4	1,000,000	0,5 ± 0,2
KSA0M411	3 ± 0,75	100,000	0,6 ± 0,2
KSA0M511	5 ± 1,5	100,000	0,7 ± 0,2
KSA0M911	3 ± 0,75	500,000	0,6 ± 0,2
KSL0M211	1,4 ± 0,4	100,000	0,5 ± 0,2
KSL0M311	1,4 ± 0,4	1,000,000	0,5 ± 0,2
KSL0M411	3 ± 0,75	100,000	0,6 ± 0,2
KSL0M511	5 ± 1,5	100,000	0,7 ± 0,2
KSL0M911	3 ± 0,75	500,000	0,6 ± 0,2

NOTE: Other versions in terms of force, termination length and corrosion protection available. Please contact your sales representative.
 This data sheet does not provide enough information for applications which require a certain level of quality or safety such as automotive, medical systems, safety equipment. Please contact your sales representative to get contractual specification package.

Electrical

	Silver	Gold
MAXIMUM POWER:	1 VA	0.2 VA
MAXIMUM VOLTAGE:	32 VDC	32 VDC
MINIMUM VOLTAGE:	20 mV	20 mV
MAXIMUM CURRENT:	50 mA	10 mA
MINIMUM CURRENT:	1 mA	1 mA
DIELECTRIC STRENGTH: 250 Vrms		
CONTACT RESISTANCE: ≤ 100m Ω		
INSULATION RESISTANCE (100 V): ≥ 10 ⁹ Ω		
BOUNCE TIME: ≤ 1 ms		

Environmental

	Silver	Gold
OPERATING TEMPERATURE:	-40°C to 85°C	-40°C to 125°C
STORAGE TEMPERATURE:	-40°C to 85°C	-55°C to 125°C

Process

Wave soldering compatible with lead free soldering profile.

Packaging

Can be delivered in tubes of 65 pieces for automatic insertion or in boxes of 500 pieces for manual insertion (250 pieces for KSL, KSLV, KSAV).

How To Order

Our easy build-a-switch concept allows you to mix and match options to create the switch you need. To order, select desired option from each category and place it in the appropriate box.

However, please note that all the combinations of these options are not feasible.

For any part number different from those listed above, please consult your local representative.

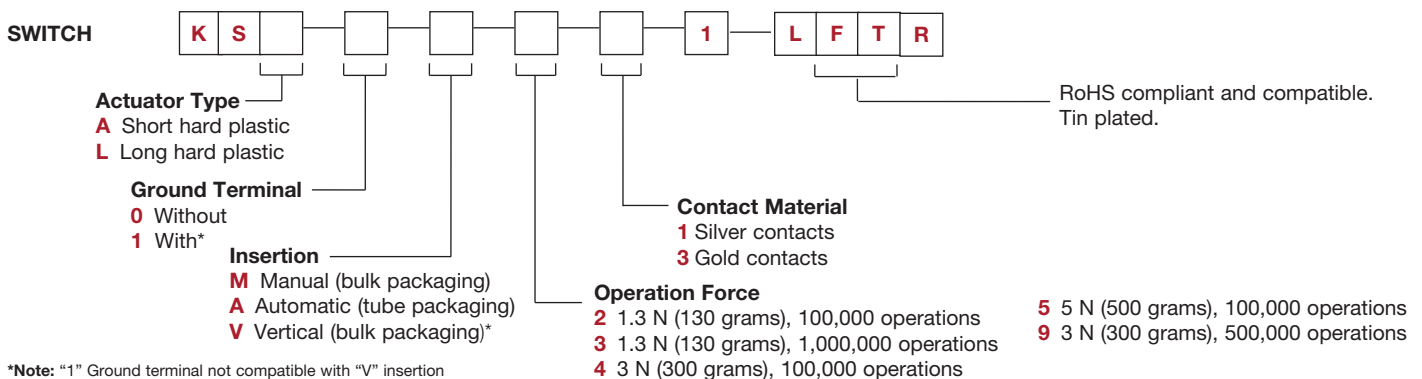

BUTTONS Buttons must be ordered separately and will be supplied in bulk.

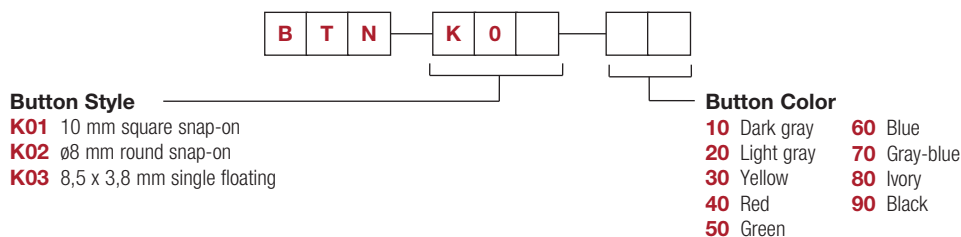

KSA & KSL Series Sealed Tact Switch

ACTUATOR TYPE

KSA & KSL

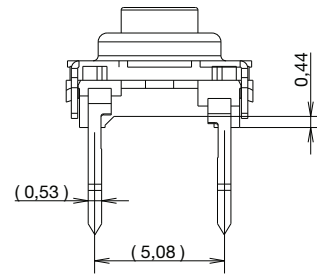
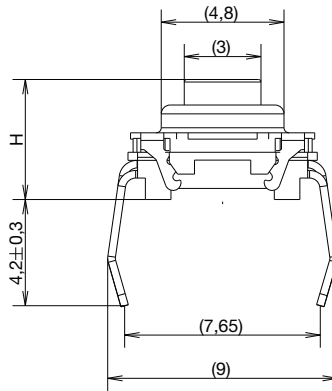

Type	H mm	inch
KSA	4,7±0,2	(.185)
KSL	9,9±0,2	(.390)

Tactile Switches

GROUND TERMINAL

0 WITHOUT

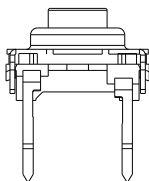

1* WITH



*Not compatible with "V" insertion



First Angle Projection

Dimensions are shown: mm
Specifications and dimensions subject to change

KSA & KSL Series Sealed Tact Switch

INSERTION

M MANUAL (BULK PACKAGING)

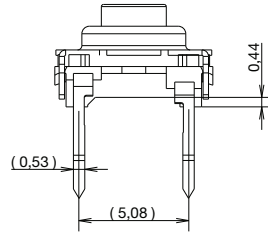

PCB LAYOUT

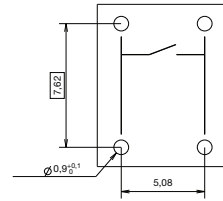

A AUTOMATIC (TUBE PACKAGING, 65 PIECES PER TUBE)



PCB LAYOUT

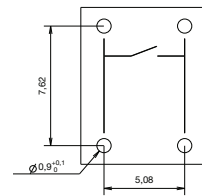

V VERTICAL

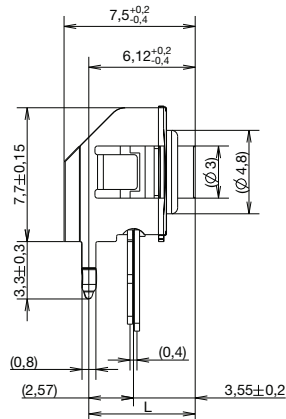
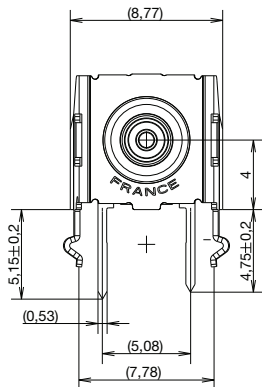

PCB LAYOUT



DIMENSION L

Type	L mm	inch
KSA0V	5,8	.228
KSL0V	11,1	.437

OPERATING FORCE

OPTION CODE	OPERATING FORCE
2	1.3 N (130 grams) 100,000 operations
3	1.3 N (130 grams) 1,000,000 operations
4	3.0 N (300 grams) 100,000 operations
5	5.0 N (500 grams) 100,000 operations
9	3.0 N (300 grams) 500,000 operations



First Angle
Projection

Dimensions are shown: mm
Specifications and dimensions subject to change

CONTACT MATERIAL



OPTION CODE	CONTACT MATERIAL
1	Silver contacts
3	Gold contacts

SEALING



OPTION CODE	SEALING
1	Sealing level IP60

BUTTONS

Buttons must be ordered separately and will be supplied in bulk.

BUTTON TYPE	KSA	KSL	KSAV	KSLV
K01	X			
K02	X			
K03	X	X	X	X

K01



Dimensions are shown: mm
Specifications and dimensions subject to change

KSA & KSL Series Sealed Tact Switch

K02

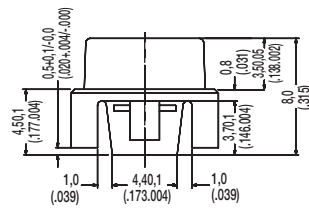
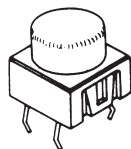

K03

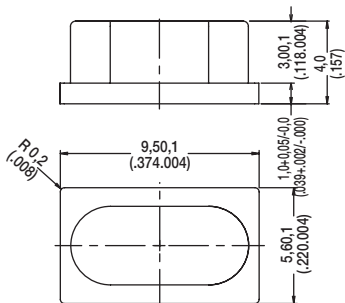

First Angle
Projection

Dimensions are shown: mm
Specifications and dimensions subject to change

Mouser Electronics

Authorized Distributor

Click to View Pricing, Inventory, Delivery & Lifecycle Information:

C&K Switches:

[BTNK0110](#) [BTNK0120](#) [BTNK0130](#) [BTNK0140](#) [BTNK0150](#) [BTNK0160](#) [BTNK0170](#) [BTNK0180](#) [BTNK0190](#)
[BTNK0210](#) [BTNK0220](#) [BTNK0230](#) [BTNK0240](#) [BTNK0250](#) [BTNK0260](#) [BTNK0270](#) [BTNK0280](#) [BTNK0290](#)
[BTNK0390](#) [BTNK0990](#) [BTNK0350](#) [BTNK0490](#) [BTNK0460](#) [BTNK0320](#) [BTNK0450](#) [BTNK0360](#) [BTNK0420](#)
[BTNK0470](#) [BTNK0300](#) [BTNK0432](#) [BTNK0100](#) [BTNK0200](#) [BTNK0480](#) [BTNK0611](#) [BTNK0301](#) [BTNK0401](#)
[BTNK0410](#) [BTNK0380](#) [BTNK0440](#)