

## SOT-23, 44V, Over-the-Top, Micropower, Precision Rail-to-Rail Comparator

### FEATURES

- Operates from 2.7V to 44V
- **Over-The-Top<sup>®</sup>: Input Common Mode Range Extends 44V Above  $V^-$ , Independent of  $V^+$**
- **Micropower: 35 $\mu$ A  $I_Q$**
- **Offset Voltage: 1.5mV Max**
- **Valid Output with Either Input 5V Below  $V^-$**
- Rail-to-Rail Output Swing
- Output Can Drive Loads Above  $V^+$
- Internal Pull-Up Current
- $-40^\circ\text{C}$  to  $125^\circ\text{C}$  Operating Temperature Range
- Low Profile (1mm) SOT-23 (ThinSOT<sup>™</sup>) Package

### APPLICATIONS

- Power Supply Monitors
- Relay/Lamp Driver
- Oscillators
- Peak Detector
- Level Shifting

### DESCRIPTION

The LT<sup>®</sup>1716 comparator operates on any total power supply voltage between 2.7V and 44V drawing 35 $\mu$ A of quiescent current. The LT1716 has a unique input stage that can be taken 44V above  $V^-$ , independent of  $V^+$  supply. (Built-in resistors protect the inputs for faults below the negative supply of up to 5V.) The inputs can withstand 44V both differential and common mode.

The output stage includes a class “B” pull-up current source, eliminating the need for an external resistive pull-up and saving power. Output voltage swings to within 35mV of the negative supply and 55mV of the positive supply, which makes the comparator a good choice for low voltage single supply operation. The output stage is also designed to drive loads connected to a higher supply than the LT1716 supply, the same as an open collector output stage.

The LT1716 is available in a SOT-23 5-lead package.

LT, LT, LTC, LTM, Over-The-Top, Linear Technology and the Linear logo are registered trademarks of Linear Technology Corporation. ThinSOT is a trademark of Linear Technology Corporation. All other trademarks are the property of their respective owners.

### TYPICAL APPLICATION

Lamp Monitor

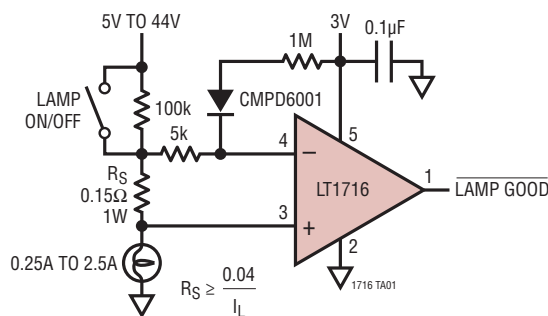

Input Bias Current vs Input Bias Voltage

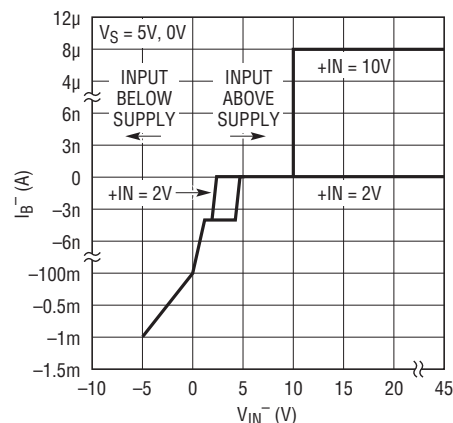

1716 TA02

# LT1716

## ABSOLUTE MAXIMUM RATINGS

(Note 1)

Supply Voltage ( $V_+$ to $V_-$ ).....	44V
Differential Input Voltage .....	44V
Input Voltage.....	44V, -5V
Output Short-Circuit Duration (Note 2) .....	Indefinite
Operating Temperature Range (Note 3)	
LT1716C/LT1716I .....	-40°C to 85°C
LT1716H.....	-40°C to 125°C
Specified Temperature Range (Note 4)	
LT1716C/LT1716I .....	-40°C to 85°C
LT1716H.....	-40°C to 125°C
Maximum Junction Temperature .....	150°C
Storage Temperature Range .....	-65°C to 150°C
Lead Temperature (Soldering, 10 sec).....	300°C

## PIN CONFIGURATION

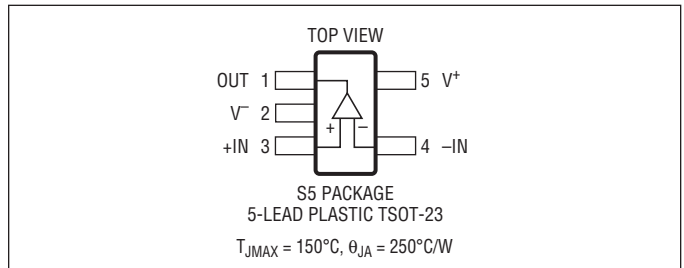

## ORDER INFORMATION

LEAD FREE FINISH	TAPE AND REEL	PART MARKING*	PACKAGE DESCRIPTION	SPECIFIED TEMPERATURE RANGE
LT1716CS5#PBF	LT1716CS5#TRPBF	LTYD	5-Lead Plastic TSOT-23	-40°C to 85°C
LT1716IS5#PBF	LT1716IS5#TRPBF	LTYD	5-Lead Plastic TSOT-23	-40°C to 85°C
LT1716HS5#PBF	LT1716HS5#TRPBF	LTYD	5-Lead Plastic TSOT-23	-40°C to 125°C

Consult LTC Marketing for parts specified with wider operating temperature ranges. \*The temperature grade is identified by a label on the shipping container. Consult LTC Marketing for information on non-standard lead based finish parts.

For more information on lead free part marking, go to: <http://www.linear.com/leadfree/>

For more information on tape and reel specifications, go to: <http://www.linear.com/tapeandreel/>

## ELECTRICAL CHARACTERISTICS

The ● denotes the specifications which apply over the full operating temperature range of  $-40^\circ\text{C} \leq T_A \leq 85^\circ\text{C}$ , otherwise specifications are at  $T_A = 25^\circ\text{C}$ . Single supply operation  $V_+ = 5\text{V}$ ,  $V_- = 0\text{V}$ ;  $V_{CM} = V_+/2$  unless otherwise noted. (Note 4)

SYMBOL	PARAMETER	CONDITIONS	LTC1716C/LT1716I			UNITS
			MIN	TYP	MAX	
$V_{OS}$	Input Offset Voltage	$0.5\text{V} < V_{CM} < (V_{CC} - 1\text{V})$		300	1600	$\mu\text{V}$
		$0^\circ\text{C} < T_A < 70^\circ\text{C}$	●		2100	$\mu\text{V}$
		$-40^\circ\text{C} < T_A < 85^\circ\text{C}$	●			2500
	Input Offset Voltage Drift (Note 5)	$0^\circ\text{C} < T_A < 70^\circ\text{C}$	●	2		$\mu\text{V}/^\circ\text{C}$
		$-40^\circ\text{C} < T_A < 85^\circ\text{C}$	●	2		$\mu\text{V}/^\circ\text{C}$
$I_{OS}$	Input Offset Current	$V_{CM} = V_+/2$	●	3	15	nA
		$V_{CM} = 0\text{V}$	●		1.3	$\mu\text{A}$
		$V_{CM} = 44\text{V}$	●		0.9	$\mu\text{A}$
$I_B$	Input Bias Current	$V_{CM} = V_+/2$	●	20	50	nA
			●	35	75	nA
		$V_+ = 0\text{V}$ , $V_{CM} = 44\text{V}$	●	2		nA
		$V_{CM} = 0\text{V}$	●	3	13	$\mu\text{A}$
		$V_{CM} = 44\text{V}$	●	6	9	$\mu\text{A}$
	$V_{CM} = -5\text{V}$	●	1	1.4	mA	
	Input Voltage Range (Note 7)		●	0.5	44	V
CMRR	Common Mode Rejection Ratio	$0.5\text{V} \leq V_{CM} < (V_+ - 1\text{V})$	●	89	110	dB
		$0.5\text{V} \leq V_{CM} < 44\text{V}$ (Note 6)	●	81	110	dB

1716fa

**ELECTRICAL CHARACTERISTICS** The ● denotes the specifications which apply over the full operating temperature range of  $-40^{\circ}\text{C} \leq T_A \leq 85^{\circ}\text{C}$ , otherwise specifications are at  $T_A = 25^{\circ}\text{C}$ . Single supply operation  $V^+ = 5\text{V}$ ,  $V^- = 0\text{V}$ ;  $V_{\text{CM}} = V^+/2$  unless otherwise noted. (Note 4)

SYMBOL	PARAMETER	CONDITIONS	LTC1716C/LT1716I			UNITS
			MIN	TYP	MAX	
PSRR	Power Supply Rejection Ratio	$V^- = 0\text{V}$ , $V_{\text{CM}} = 1.5\text{V}$ ; $2.7\text{V} < V^+ < 36\text{V}$	●	95	110	dB
	Minimum Operating Supply Voltage		●		2.4 2.7	V
$A_{\text{VOL}}$	Large-Signal Voltage Gain	$R_L = 1\text{k}$ ; $1\text{V} < V_{\text{OUT}} < 4\text{V}$	●	200	500	V/mV
			●	100		V/mV
$I_S$	Supply Current	$V^+ = 3\text{V}$ , $R_L = \text{Open}$ , $V_O = \text{High}$	●		35 50	$\mu\text{A}$
					65	$\mu\text{A}$
		$V^+ = 5\text{V}$ , $R_L = \text{Open}$ , $V_O = \text{High}$	●		35 55	$\mu\text{A}$
					75	$\mu\text{A}$
		$V^+ = 12\text{V}$ , $R_L = \text{Open}$ , $V_O = \text{High}$	●		40 60	$\mu\text{A}$
					85	$\mu\text{A}$
$I_{\text{SC}}^-$	Output Sink Current (Note 2)	$V_{\text{OVERDRIVE}} > 30\text{mV}$	●	10	20	mA
$I_{\text{SC}}^+$	Output Source Current	$V_{\text{OVERDRIVE}} = 5\text{mV}$ , $V_{\text{OUT}} = 1\text{V}$	●	60	85	$\mu\text{A}$
$V_{\text{OL}}$	Output Voltage Swing Low (Referred to $V^-$ )	$I_{\text{SINK}} = 0\text{mA}$ , $V_{\text{OVERDRIVE}} = -10\text{mV}$	●		20 35	mV
		$I_{\text{SINK}} = 0.1\text{mA}$	●		75 110	mV
		$I_{\text{SINK}} = 1\text{mA}$	●		200 300	mV
		$I_{\text{SINK}} = 5\text{mA}$	●		550 900	mV
$V_{\text{OH}}$	Output Voltage Swing High (Referred to $V^+$ )	$I_{\text{SOURCE}} = 0\mu\text{A}$ , $V_{\text{OVERDRIVE}} = 10\text{mV}$	●		30 55	mV
		$I_{\text{SOURCE}} = 10\mu\text{A}$	●		130 185	mV
	Leakage Current	$V_{\text{OUT}} = 40\text{V}$ , $V_{\text{OVERDRIVE}} > 100\text{mV}$	●		0.5 2	$\mu\text{A}$
	Propagation Delay	$V_{\text{OVERDRIVE}} > 100\text{mV}$ , $R_{\text{LOAD}} = 10\text{k}$			3 5.5	$\mu\text{s}$

The ● denotes the specifications which apply over the full operating temperature range of  $-40^{\circ}\text{C} \leq T_A \leq 85^{\circ}\text{C}$ , otherwise specifications are at  $T_A = 25^{\circ}\text{C}$ . Split supply operation  $V_S = \pm 15\text{V}$ ,  $V_{\text{CM}} = 0\text{V}$  unless otherwise noted. (Note 4)

SYMBOL	PARAMETER	CONDITIONS	LT1716C/LT1716I			UNITS
			MIN	TYP	MAX	
$V_{\text{OS}}$	Input Offset Voltage	$-14.5\text{V} < V_{\text{CM}} < 14\text{V}$	●		300 1500	$\mu\text{V}$
		$0^{\circ}\text{C} < T_A < 70^{\circ}\text{C}$	●		2000	$\mu\text{V}$
		$-40^{\circ}\text{C} < T_A < 85^{\circ}\text{C}$	●		2400	$\mu\text{V}$
	Input Offset Voltage Drift (Note 5)	$0^{\circ}\text{C} < T_A < 70^{\circ}\text{C}$	●		2	$\mu\text{V}/^{\circ}\text{C}$
		$-40^{\circ}\text{C} < T_A < 85^{\circ}\text{C}$	●		2	$\mu\text{V}/^{\circ}\text{C}$
$I_{\text{OS}}$	Input Offset Current	$V_{\text{CM}} = 0\text{V}$	●		3 15	nA
		$V_{\text{CM}} = 29\text{V}$	●		0.9	$\mu\text{A}$
		$V_{\text{CM}} = -15\text{V}$	●		1.3	$\mu\text{A}$
$I_B$	Input Bias Current	$V_{\text{CM}} = 0\text{V}$	●		30 60	nA
					50 100	nA
		$V_{\text{CM}} = 29\text{V}$	●		6 9	$\mu\text{A}$
		$V_{\text{CM}} = -15\text{V}$	●		3 13	$\mu\text{A}$
		$V_{\text{CM}} = -20\text{V}$	●		1 1.4	mA
	Input Voltage Range (Note 7)		●	-14.5	14	V
CMRR	Common Mode Rejection Ratio	$-14.5\text{V} < V_{\text{CM}} < 14\text{V}$	●	92	110	dB
		$-14.5\text{V} < V_{\text{CM}} < 29\text{V}$ (Note 6)	●	81	98	dB
PSRR	Power Supply Rejection Ratio	$V_S = \pm 1.35\text{V}$ to $\pm 22\text{V}$	●	90	110	dB
	Minimum Operating Supply Voltage		●		2.4 2.7	V
$A_{\text{VOL}}$	Large-Signal Voltage Gain	$R_L = 6\text{k}$ ; $-14\text{V} < V_{\text{OUT}} < 14\text{V}$	●	500	1000	V/mV
			●	400		V/mV
$I_S$	Supply Current	$V_S = \pm 15\text{V}$ , $R_L = \text{Open}$ , $V_O = \text{High}$	●		40 95	$\mu\text{A}$
$I_{\text{SC}}^-$	Output Sink Current (Note 2)	$V_{\text{OVERDRIVE}} > 30\text{mV}$	●	10	20	mA
$I_{\text{SC}}^+$	Output Source Current	$V_{\text{OVERDRIVE}} = 5\text{mV}$ , $V_{\text{OUT}} = -14\text{V}$	●	70	105	$\mu\text{A}$

## ELECTRICAL CHARACTERISTICS

The ● denotes the specifications which apply over the full operating temperature range of  $-40^{\circ}\text{C} \leq T_A \leq 85^{\circ}\text{C}$ , otherwise specifications are at  $T_A = 25^{\circ}\text{C}$ . Split supply operation  $V_S = \pm 15\text{V}$ ,  $V_{CM} = 0\text{V}$  unless otherwise noted. (Note 4)

SYMBOL	PARAMETER	CONDITIONS	LT1716C/LT1716I			UNITS
			MIN	TYP	MAX	
$V_{OL}$	Output Voltage Swing Low (Referred to $V^-$ )	$I_{SINK} = 0\text{mA}$ , $V_{OVERDRIVE} = -10\text{mV}$	●	20	35	mV
		$I_{SINK} = 0.1\text{mA}$	●	75	110	mV
		$I_{SINK} = 1\text{mA}$	●	200	300	mV
		$I_{SINK} = 5\text{mA}$	●	550	900	mV
$V_{OH}$	Output Voltage Swing High (Referred to $V^+$ )	$I_{SOURCE} = 0\mu\text{A}$ , $V_{OVERDRIVE} = 10\text{mV}$	●	45	75	mV
		$I_{SOURCE} = 10\mu\text{A}$	●	140	210	mV
	Leakage Current	$V_{OUT} = 25\text{V}$ , $V_{OVERDRIVE} > 100\text{mV}$	●	0.6	2	$\mu\text{A}$
	Propagation Delay	$V_{OVERDRIVE} > 100\text{mV}$ , $R_{LOAD} = 10\text{k}$		5.5	9	$\mu\text{s}$

The ● denotes the specifications which apply over the full operating temperature range of  $-40^{\circ}\text{C} < T_A < 125^{\circ}\text{C}$ , otherwise specifications are at  $T_A = 25^{\circ}\text{C}$ . Single supply operation  $V^+ = 5\text{V}$ ,  $V^- = 0\text{V}$ ;  $V_{CM} = V_{CC}/2$  unless otherwise noted. (Note 4)

SYMBOL	PARAMETER	CONDITIONS	LT1716H			UNITS
			MIN	TYP	MAX	
$V_{OS}$	Input Offset Voltage	$0.5\text{V} < V_{CM} < (V_{CC} - 1\text{V})$	●	300	1600	$\mu\text{V}$
	Input Offset Voltage Drift (Note 5)		●	2	2900	$\mu\text{V}/^{\circ}\text{C}$
$I_{OS}$	Input Offset Current	$V_{CM} = V^+/2$	●	3	220	nA
		$V_{CM} = 0\text{V}$	●		1.3	$\mu\text{A}$
		$V_{CM} = 44\text{V}$	●		0.9	$\mu\text{A}$
$I_B$	Input Bias Current	$V_{CM} = V^+/2$	●	20	50	nA
					900	nA
		$V^+ = 0\text{V}$ , $V_{CM} = 44\text{V}$	●	2		nA
		$V_{CM} = 0\text{V}$	●	3	25	$\mu\text{A}$
		$V_{CM} = 44\text{V}$	●	6	14	$\mu\text{A}$
		$V_{CM} = -5\text{V}$	●	1	1.4	mA
	Input Voltage Range (Note 7)			0.5	44	V
CMRR	Common Mode Rejection Ratio	$0.5\text{V} < V_{CM} < (V^+ - 1\text{V})$	●	75	110	dB
		$0.5\text{V} < V_{CM} < 44\text{V}$ (Note 6)	●	72	110	dB
PSRR	Power Supply Rejection Ratio	$V^- = 0\text{V}$ , $V_{CM} = 1.5\text{V}$ , $2.7\text{V} < V^+ < 36\text{V}$	●	85	110	dB
	Minimum Operating Supply Voltage		●	2.4	2.7	V
$A_{VOL}$	Large-Signal Voltage Gain	$R_L = 1\text{k}$ , $1\text{V} < V_{OUT} < 4\text{V}$	●	200	500	V/mV
		$R_L = 6\text{k}$	●	20		V/mV
$I_S$	Supply Current per Amplifier	$V^+ = 3\text{V}$ , $R_L = \text{Open}$ , $V_O = \text{High}$	●	35	50	$\mu\text{A}$
					70	$\mu\text{A}$
		$V^+ = 5\text{V}$ , $R_L = \text{Open}$ , $V_O = \text{High}$	●	35	55	$\mu\text{A}$
					75	$\mu\text{A}$
		$V^+ = 12\text{V}$ , $R_L = \text{Open}$ , $V_O = \text{High}$	●	40	60	$\mu\text{A}$
					85	$\mu\text{A}$
$I_{SC}^-$	Output Sink Current (Note 2)	$V_{OVERDRIVE} > 30\text{mV}$	●	5	10	mA
$I_{SC}^+$	Output Source Current	$V_{OVERDRIVE} = 5\text{mV}$ , $V_{OUT} = 1\text{V}$	●	60	110	$\mu\text{A}$
$V_{OL}$	Output Voltage Swing Low (Referred to $V^-$ )	$I_{SINK} = 0\text{mA}$ , $V_{OVERDRIVE} = -10\text{mV}$	●	20	60	mV
		$I_{SINK} = 0.1\text{mA}$	●	75	170	mV
		$I_{SINK} = 1\text{mA}$	●	200	480	mV
		$I_{SINK} = 5\text{mA}$	●	550	1200	mV
$V_{OH}$	Output Voltage Swing High (Referred to $V^+$ )	$I_{SOURCE} = 0\mu\text{A}$ , $V_{OVERDRIVE} = -10\text{mV}$	●	50	110	mV
		$I_{SOURCE} = 10\mu\text{A}$	●	130	220	mV
	Leakage Current	$V_{OUT} = 40\text{V}$ , $V_{OVERDRIVE} > 100\text{mV}$	●	1.7	5	$\mu\text{A}$
	Propagation Delay	$V_{OVERDRIVE} > 100\text{mV}$ , $R_{LOAD} = 10\text{k}$		6	9	$\mu\text{s}$

**ELECTRICAL CHARACTERISTICS** The ● denotes the specifications which apply over the full operating temperature range of  $-40^{\circ}\text{C} < T_A < 125^{\circ}\text{C}$ , otherwise specifications are at  $T_A = 25^{\circ}\text{C}$ . Split supply operation  $V_S = \pm 15\text{V}$ ,  $V_{CM} = 0\text{V}$  unless otherwise noted. (Note 4)

SYMBOL	PARAMETER	CONDITIONS	LT1716H			UNITS
			MIN	TYP	MAX	
$V_{OS}$	Input Offset Voltage	$-14.5\text{V} < V_{CM} < 14\text{V}$	●	300	1500 2900	$\mu\text{V}$ $\mu\text{V}$
	Input Offset Voltage Drift (Note 5)		●	2		$\mu\text{V}/^{\circ}\text{C}$
$I_{OS}$	Input Offset Current	$V_{CM} = 0\text{V}$	●	3	280	nA
		$V_{CM} = 29\text{V}$	●		0.9	$\mu\text{A}$
		$V_{CM} = -15\text{V}$	●		1.3	$\mu\text{A}$
$I_B$	Input Bias Current	$V_{CM} = 0\text{V}$	●	30 50	60 1400	nA nA
		$V_{CM} = 29\text{V}$	●	6	20	$\mu\text{A}$
		$V_{CM} = -15\text{V}$	●	3	30	$\mu\text{A}$
		$V_{CM} = -20\text{V}$	●	1	1.4	mA
	Input Voltage Range (Note 7)		●	-14.5	14	V
CMRR	Common Mode Rejection Ratio	$-14.5\text{V} < V_{CM} < 14\text{V}$	●	85	110	dB
		$-14.5\text{V} < V_{CM} < 29\text{V}$ (Note 6)	●	70	93	dB
PSRR	Power Supply Rejection Ratio	$V_S = \pm 1.35\text{V}$ to $\pm 22\text{V}$	●	80	110	dB
		Minimum Operating Supply Voltage	●	2.4	2.7	V
$A_{VOL}$	Large-Signal Voltage Gain	$R_L = 6\text{k}; -14\text{V} < V_{OUT} < 14\text{V}$	●	500	1000	V/mV
		$R_L = 6\text{k}; -13\text{V} < V_{OUT} < 13\text{V}$	●	50		V/mV
$I_S$	Supply Current	$V_S = \pm 15\text{V}$ , $R_L = \text{Open}$ , $V_O = \text{High}$		40	95	$\mu\text{A}$
$I_{SC}^-$	Output Sink Current (Note 2)	$V_{OVERDRIVE} > 30\text{mV}$	●	5	10	mA
$I_{SC}^+$	Output Source Current	$V_{OVERDRIVE} = 5\text{mV}$ , $V_{OUT} = -14\text{V}$	●	70	155	$\mu\text{A}$
$V_{OL}$	Output Voltage Swing Low (Referred to $V^-$ )	$I_{SINK} = 0\text{mA}$ , $V_{OVERDRIVE} = -10\text{mV}$	●	20	70	mV
		$I_{SINK} = 0.1\text{mA}$	●	75	170	mV
		$I_{SINK} = 1\text{mA}$	●	200	480	mV
		$I_{SINK} = 5\text{mA}$	●	550	1200	mV
$V_{OH}$	Output Voltage Swing High (Referred to $V^+$ )	$I_{SOURCE} = 0\mu\text{A}$ , $V_{OVERDRIVE} = 10\text{mV}$	●	45	120	mV
		$I_{SOURCE} = 10\mu\text{A}$	●	140	250	mV
	Leakage Current	$V_{OUT} = 25\text{V}$ , $V_{OVERDRIVE} > 100\text{mV}$	●	1.5	5	$\mu\text{A}$
	Propagation Delay	$V_{OVERDRIVE} > 100\text{mV}$ , $R_{LOAD} = 10\text{k}$		5.5	10	$\mu\text{s}$

**Note 1:** Stresses beyond those listed under Absolute Maximum Ratings may cause permanent damage to the device. Exposure to any Absolute Maximum Rating condition for extended periods may affect device reliability and lifetime.

**Note 2:** A heat sink may be required to keep the junction temperature below absolute maximum.

**Note 3:** The LT1716C/LT1716I are guaranteed functional over the operating temperature range of  $-40^{\circ}\text{C}$  to  $85^{\circ}\text{C}$ . The LT1716H is guaranteed functional over the operating temperature range of  $-40^{\circ}\text{C}$  to  $125^{\circ}\text{C}$ .

**Note 4:** The LT1716C is guaranteed to meet specified performance from  $0^{\circ}\text{C}$  to  $70^{\circ}\text{C}$ . The LT1716C is designed, characterized and expected to meet performance from  $-40^{\circ}\text{C}$  to  $85^{\circ}$  but is not tested or QA sampled at the temperatures. The LT1716I is guaranteed to meet specified performance from  $-40^{\circ}\text{C}$  to  $85^{\circ}\text{C}$ . The LT1716H is guaranteed to meet specified performance from  $-40^{\circ}\text{C}$  to  $125^{\circ}\text{C}$ .

**Note 5:** This parameter is not 100% tested.

**Note 6:** Typical input offset voltage of  $500\mu\text{V}$  at  $V_{CM} = 44\text{V}$  above  $V^-$  and a maximum input offset voltage of  $4\text{mV}$  at  $V_{CM} = 44\text{V}$  above  $V^-$ .

**Note 7:** If one input is within this input range, the other input can go  $5\text{V}$  below  $V^-$  and the output will be valid.

TYPICAL PERFORMANCE CHARACTERISTICS

Input Bias Current vs Common Mode Voltage

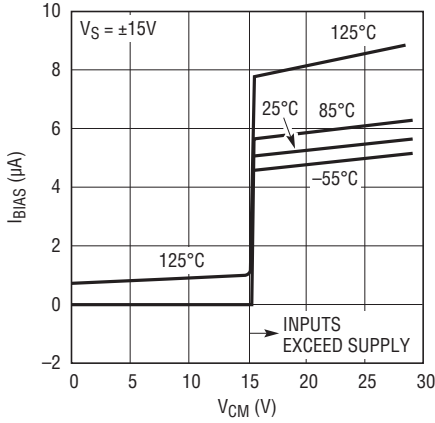

1716 G01

Input Bias Current vs Temperature

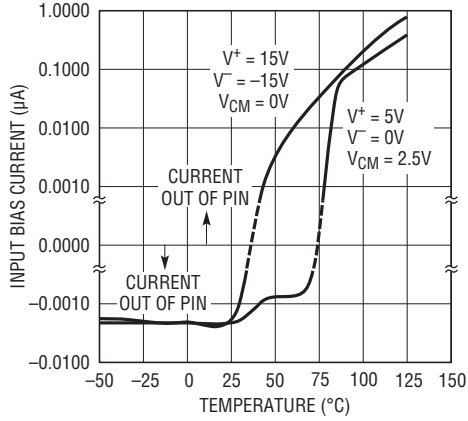

1716 G02

Input Bias Current vs Differential Input Voltage

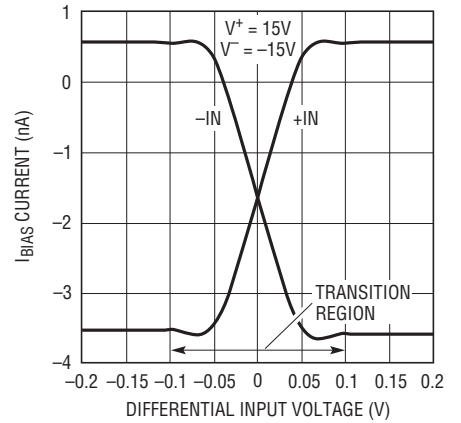

1716 G03

Output Low Voltage vs Sink Current

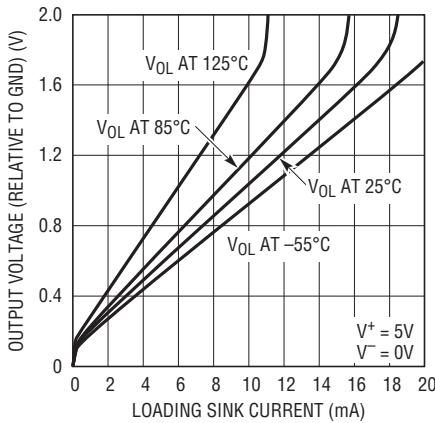

1716 G04

Output High Voltage vs Source Current

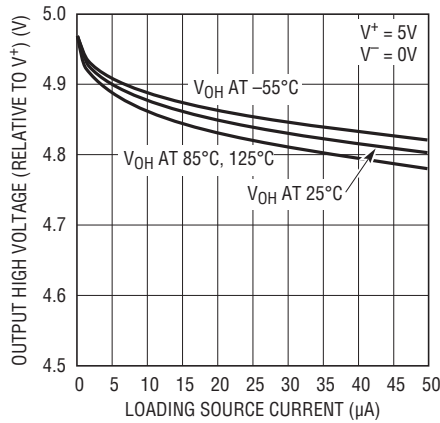

1716 G05

Input Bias Current with Inputs Driven Above the Supply

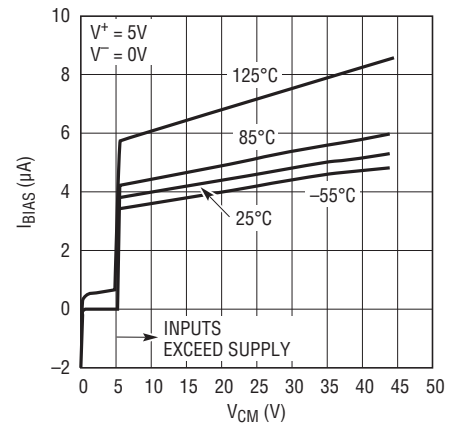

1716 G06

Input Bias Current with Inputs Driven Below the Supply

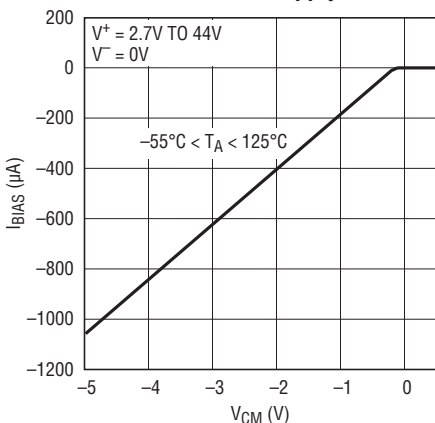

1716 G07

Supply Current vs Temperature

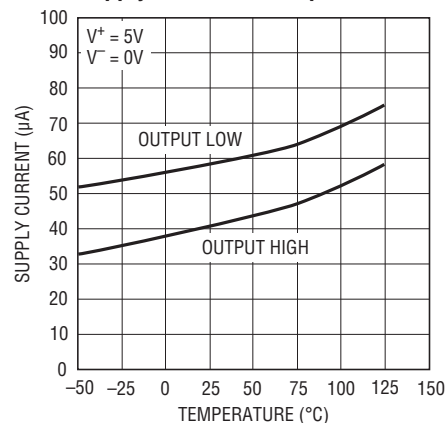

1716 G08

Positive Supply Current vs Output Sinking Current

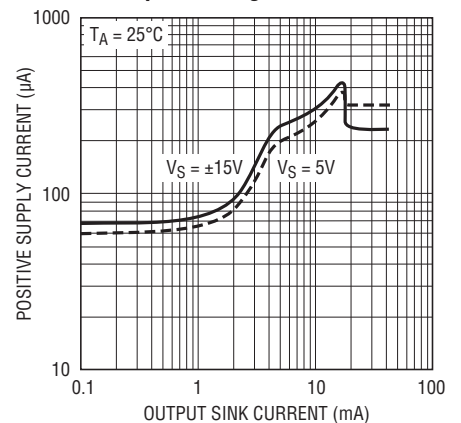

1716 G09

# TYPICAL PERFORMANCE CHARACTERISTICS

**Output Leakage Current vs Output Voltage**

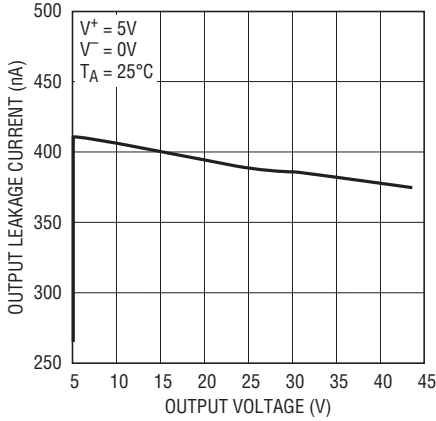

1716 G10

**Reverse Supply Current**

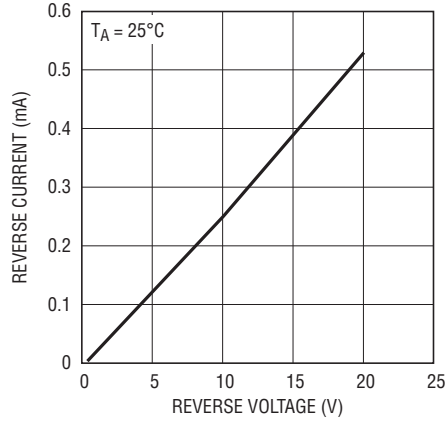

1716 G27

**Output Sinking Current Limit vs Temperature**

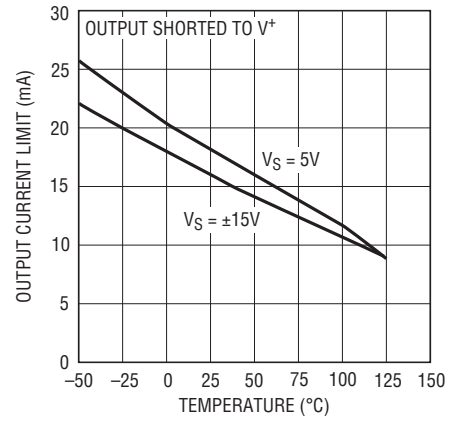

1716 G11

**Output Sinking Current vs Total Supply Voltage**

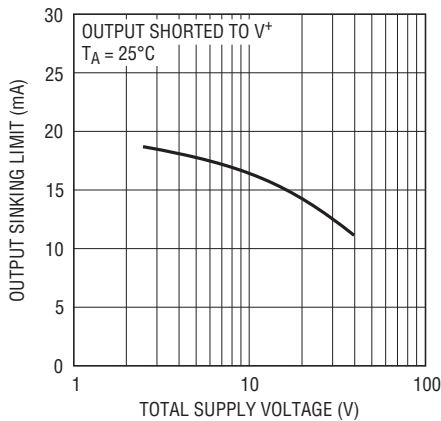

1716 G12

**Total Switching Time vs Temperature**

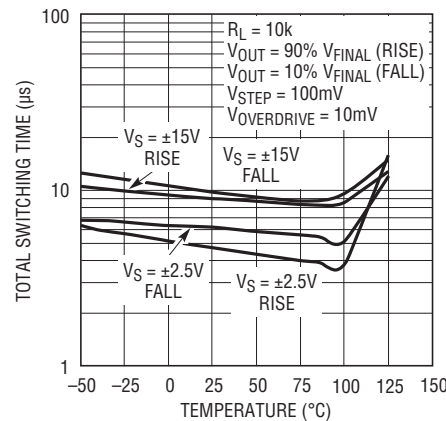

1716 G13

**Total Switching Time vs Overdrive**

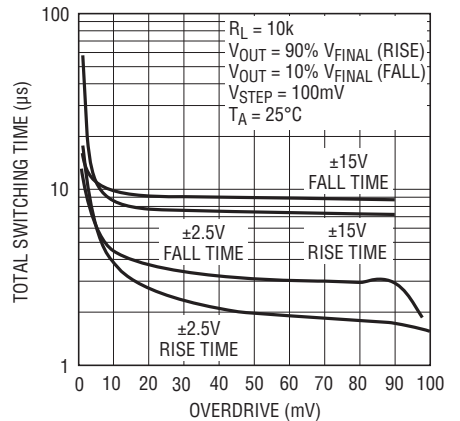

1716 G14

**Total Switching Time vs Total Supply Voltage**

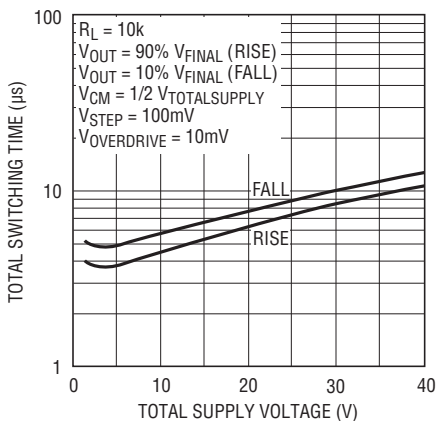

1716 G15

**Total Switching Time vs Pull-Up Resistor**

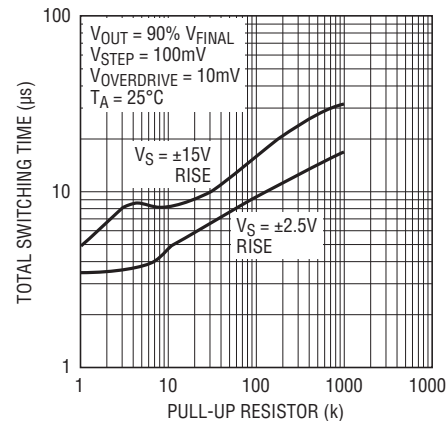

1716 G16

**Response Time**

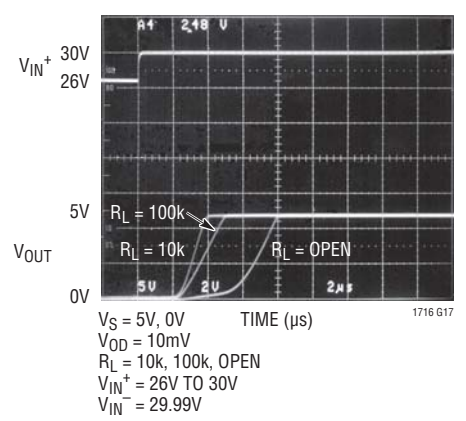

1716 G17

TYPICAL PERFORMANCE CHARACTERISTICS

Response Time

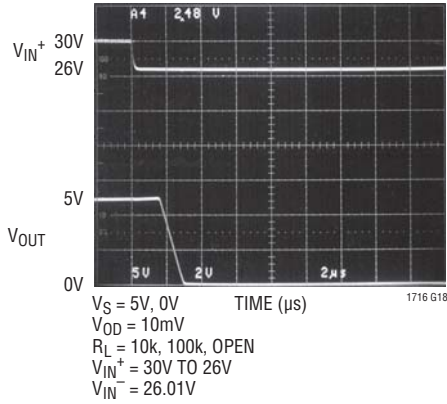

Response Time

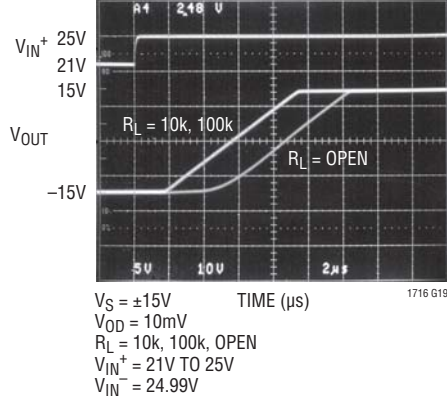

Response Time

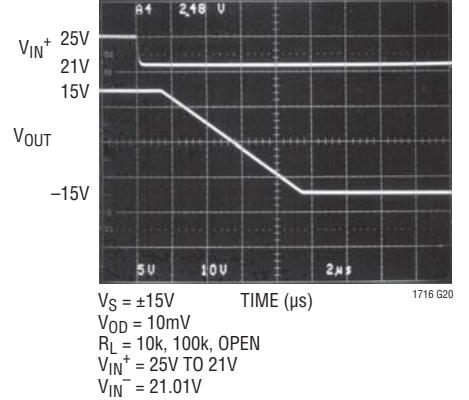

Response Time

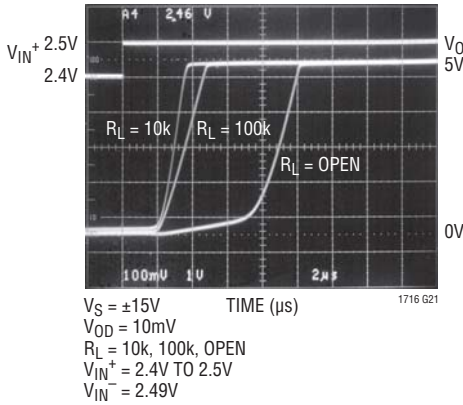

Response Time

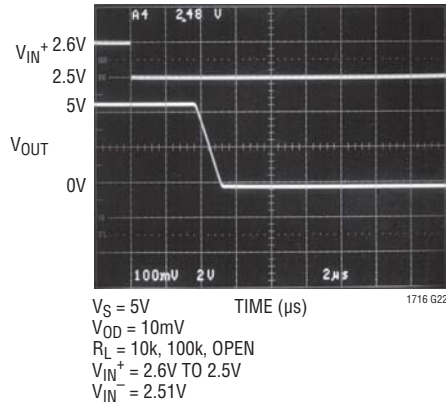

Response Time

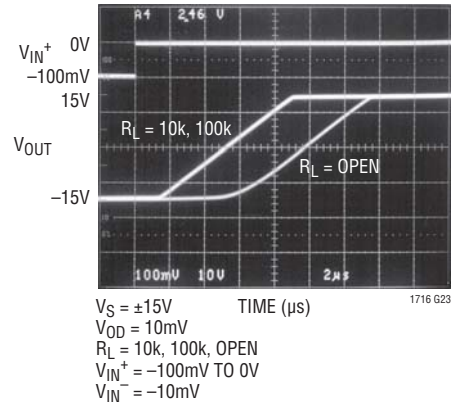

Response Time

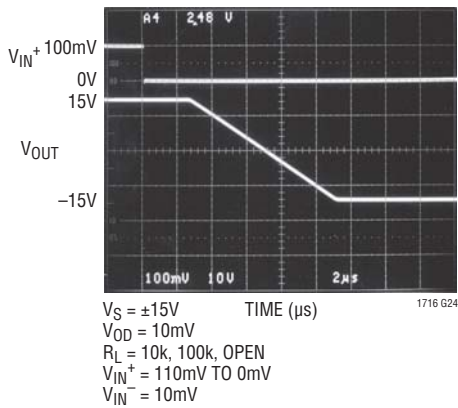

Below  $V_{S-}$  Fault (Rising)

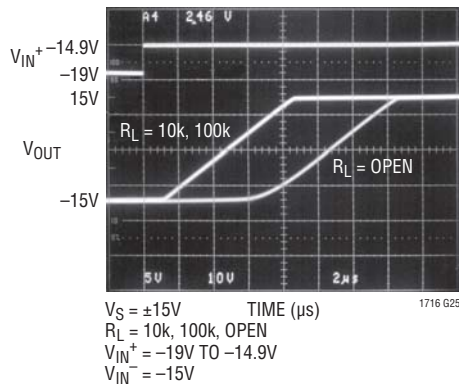

Below  $V_{S-}$  Fault (Falling)

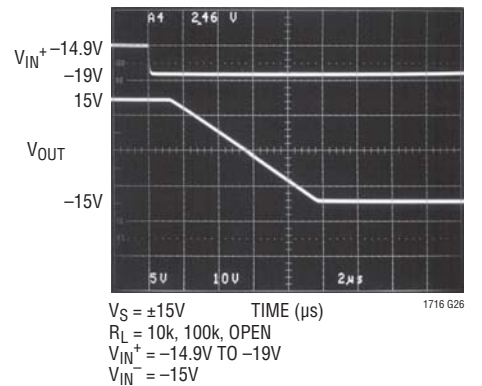



## APPLICATIONS INFORMATION

The LT1716 comparator features low power operation with exceptional input precision with rail-to-rail input and output swing. The comparator operates flawlessly even when the inputs are pulled over the positive rail or below the negative rail.

### Supply Voltage

The LT1716 operates from 2.7V to 44V. The comparator can be shut down by removing  $V^+$ . In this condition, the input bias current is typically less than 3nA, even if the inputs are 44V above the negative supply. The LT1716 is protected against reverse battery voltages of up to 20V. The reverse battery current is resistive as shown in the Reverse Supply Current graph.

### Inputs

The comparator inputs can swing from 0.5V above to 44V above  $V^-$ . If one input is within this range, the other input can be forced up to 5V below  $V^-$  without phase reversal occurring at the output.

The LT1716 has three stages—NPN, PNP and common base (see Simplified Schematic)—resulting in three distinct operating regions and two transition regions as shown in the Input Bias Current vs Common Mode typical performance curve.

For input voltages about 0.8V or more below  $V^+$ , the PNP input stage is active and the input bias current is typically  $-4$ nA. The PNP differential input stage will have bias current that flows out of the device. With a differential input voltage of even just 100mV or so, there will be zero bias current into the higher of the two inputs, while the current flowing out of the lower input will be twice the measured bias current.

When the input voltage is about 0.5V or less from  $V^+$ , the NPN state is operating and the input bias current is typically 10nA. Increases in temperature will cause the voltage at which operation switches from the PNP stage to the NPN stage to move towards  $V^+$ . The input offset voltage of the NPN stage is untrimmed and is typically 500 $\mu$ V.

A Schottky diode in the collector of each NPN transistor of the NPN input stage allows the LT1716 to operate with either or both of its inputs above  $V^+$ . At about 0.3V above  $V^+$ , the NPN transistor is fully saturated and the input bias current is typically 4 $\mu$ A at room temperature. The input offset voltage is typically 500 $\mu$ V when operating above  $V^+$ . The LT1716 will operate with its input 44V above  $V^-$ , regardless of  $V^+$ .

The transition to the negative common mode input stage occurs at 0.3V above  $V^-$ . Above this trip point the PNP stage is active. When the inputs are 0.3V below  $V^-$ , the common base input stage is active in addition to the PNP stage. The input bias current out of each input becomes  $V_{IN}/5k\Omega$ . The LT1716 is designed to operate when either input falls below the negative supply. Internal resistors protect the inputs for faults below the negative supply of up to 5V without phase reversal. The built-in 5k resistor limits the current at each input to 1mA at 5V below the negative supply. External matched input resistors can be added for increased voltage fault operation below the negative supply but the maximum input current should be kept under 1mA.

### Input Protection

The inverting and noninverting input pins of the LT1716 have on-chip protection. ESD protection is provided to prevent damage during handling. The input transistors have voltage clamping and limiting resistors to protect against excursions as much as 5V below  $V^-$ . There are no clamping diodes between the inputs and the maximum differential input voltage is 44V.

### Output

The output stage of the LT1716 can drive loads connected to a supply more positive than the device, the same as comparators with open collector output stages. The output of the LT1716 can be pulled up to 44V above  $V^-$ , regardless of  $V^+$ .

SIMPLIFIED SCHEMATIC

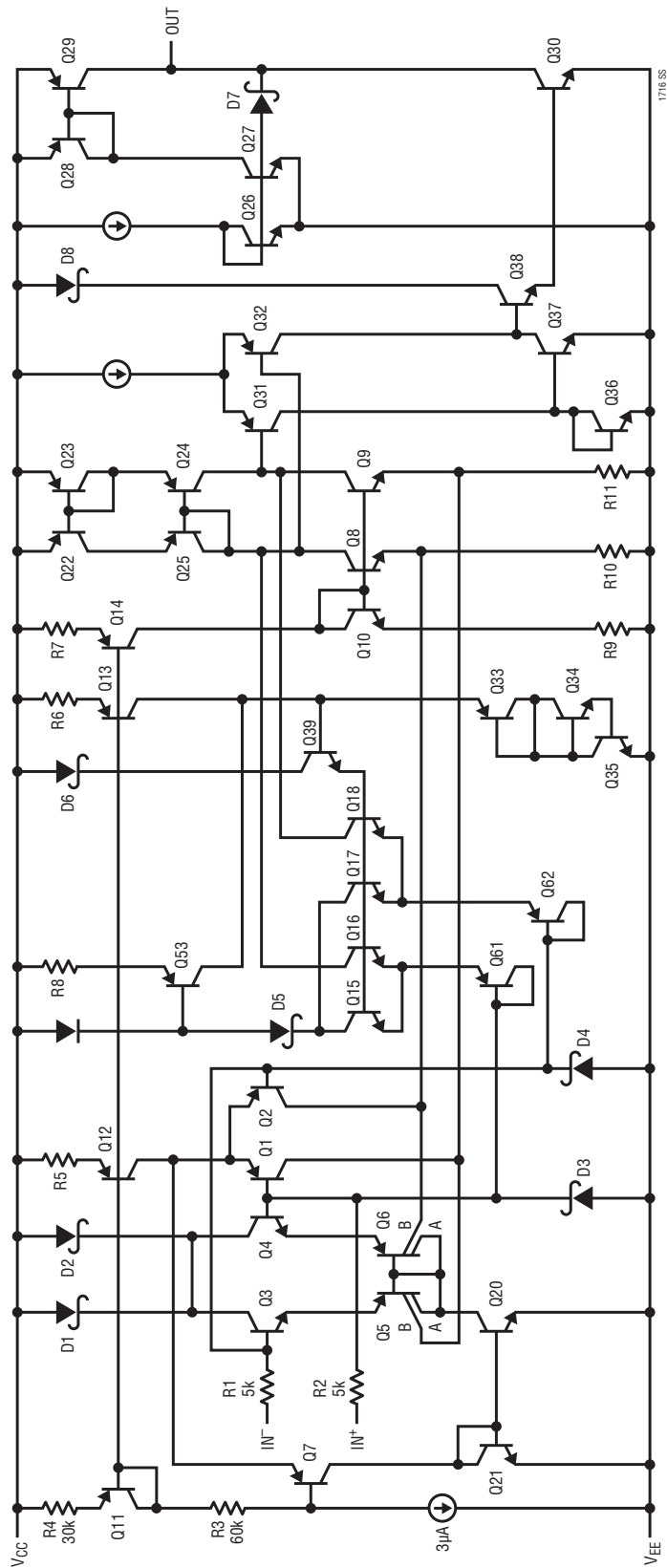

# PACKAGE DESCRIPTION

## S5 Package 5-Lead Plastic TSOT-23 (Reference LTC DWG # 05-08-1635)

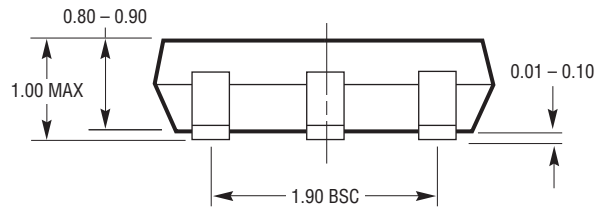
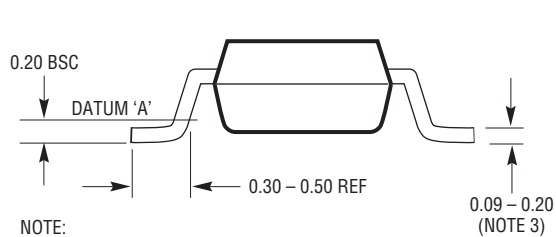
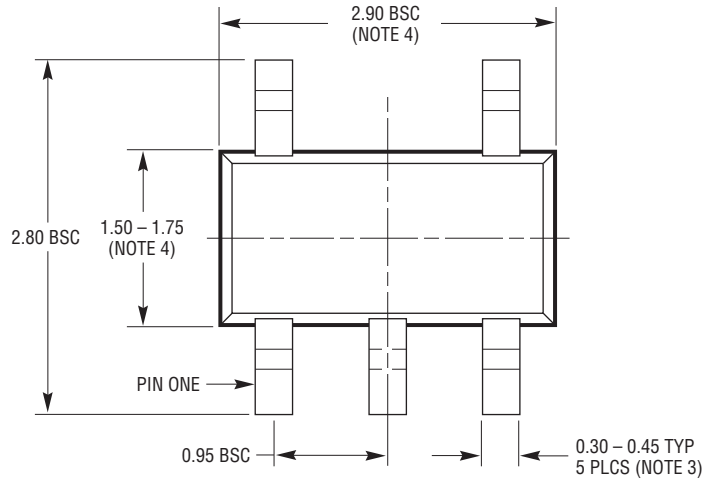
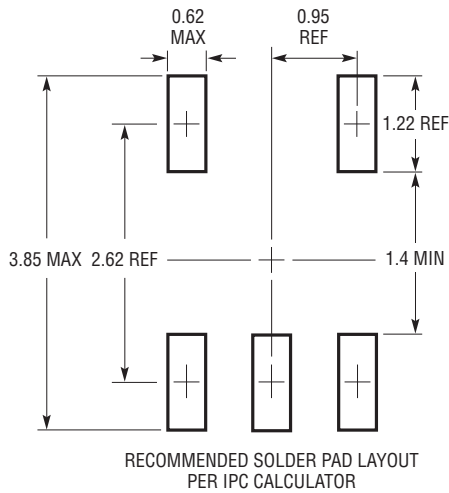

- NOTE:
1. DIMENSIONS ARE IN MILLIMETERS
  2. DRAWING NOT TO SCALE
  3. DIMENSIONS ARE INCLUSIVE OF PLATING
  4. DIMENSIONS ARE EXCLUSIVE OF MOLD FLASH AND METAL BURR
  5. MOLD FLASH SHALL NOT EXCEED 0.254mm
  6. JEDEC PACKAGE REFERENCE IS MO-193

S5 TSOT-23 0302

## TYPICAL APPLICATIONS

### Overcurrent Flag

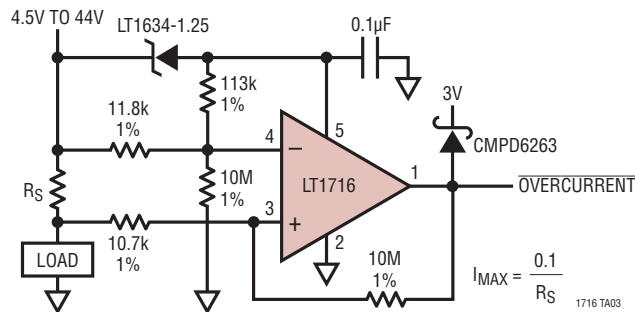

### Charge/Discharge Indicator

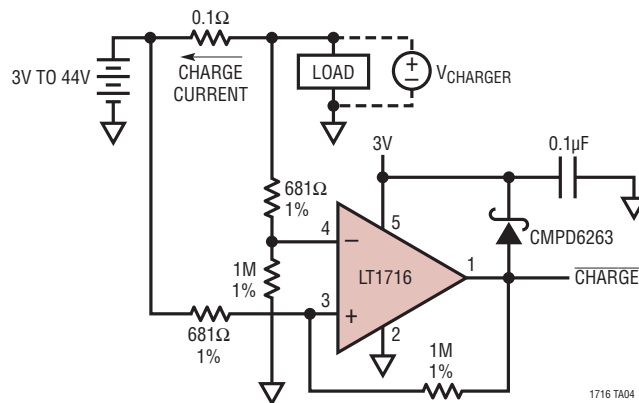

## RELATED PARTS

PART NUMBER	DESCRIPTION	COMMENTS
LTC1442	Dual Micropower Comparator and 1% Reference	1.182V ±1% Reference, ±10mV <sub>MAX</sub> Input Offset
LTC1540	Nanopower Comparator and 1% Reference	1.182V ±1% Reference, ±10mV <sub>MAX</sub> Input Offset
LT1634	Micropower Precision Shunt Reference	0.05%, 10µA, 10ppm/°C Max Drift, 1.25V, 2.5V, 4.096V, 5V, MSOP, SO-8, TO-92 Packages
LTC1921	Dual -48V Telecom Supply Monitor	Monitors Two Supplies and Fuses
LTC1998	Micropower Li-Ion Battery Monitor	1% Trip Point Adjustable from 2.5V to 3.25V

# Mouser Electronics

Authorized Distributor

Click to View Pricing, Inventory, Delivery & Lifecycle Information:

## [Analog Devices Inc.:](#)

[LT1716CS5#TRPBF](#) [LT1716HS5#TR](#) [LT1716HS5#TRM](#) [LT1716IS5](#) [LT1716IS5#PBF](#) [LT1716CS5#TR](#) [LT1716CS5](#)  
[LT1716IS5#TRPBF](#) [LT1716HS5#TRMPBF](#) [LT1716IS5#TR](#) [LT1716CS5#PBF](#) [LT1716IS5#TRM](#)  
[LT1716CS5#TRMPBF](#) [LT1716CS5#TRM](#) [LT1716HS5#PBF](#) [LT1716HS5#TRPBF](#) [LT1716IS5#TRMPBF](#) [LT1716HS5](#)