

Ultrafast Soft Recovery Diode, 80 A FRED Pt®



PowerTab®

FEATURES

- Ultrafast recovery time
- 175 °C max. operating junction temperature
- Screw mounting only
- Designed and qualified according to JEDEC®-JESD 47
- PowerTab® package
- Material categorization: for definitions of compliance please see www.vishay.com/doc?99912

RoHS
COMPLIANT

BENEFITS

- Reduced RFI and EMI
- Higher frequency operation
- Reduced snubbing
- Reduced parts count

DESCRIPTION / APPLICATIONS

These diodes are optimized to reduce losses and EMI/RFI in high frequency power conditioning systems.

The softness of the recovery eliminates the need for a snubber in most applications. These devices are ideally suited for HF welding, power converters and other applications where switching losses are not significant portion of the total losses.

PRODUCT SUMMARY	
Package	PowerTab®
$I_{F(AV)}$	80 A
V_R	200 V
V_F at I_F	0.79 V
t_{rr} (typ.)	See recovery table
T_J max.	175 °C
Diode variation	Single die

ABSOLUTE MAXIMUM RATINGS				
PARAMETER	SYMBOL	TEST CONDITIONS	MAX.	UNITS
Cathode to anode voltage	V_R		200	V
Continuous forward current	$I_{F(AV)}$	$T_C = 112\text{ °C}$	80	A
Single pulse forward current	I_{FSM}	$T_C = 25\text{ °C}$	800	
Maximum repetitive forward current	I_{FRM}	Square wave, 20 kHz	160	
Operating junction and storage temperatures	T_J, T_{Stg}		-55 to +175	°C

ELECTRICAL SPECIFICATIONS ($T_J = 25\text{ °C}$ unless otherwise specified)						
PARAMETER	SYMBOL	TEST CONDITIONS	MIN.	TYP.	MAX.	UNITS
Breakdown voltage, blocking voltage	V_{BR}, V_r	$I_R = 50\text{ }\mu\text{A}$	200	-	-	V
Forward voltage	V_F	$I_F = 80\text{ A}$	-	0.98	1.13	V
		$I_F = 80\text{ A}, T_J = 175\text{ °C}$	-	0.79	0.92	
Reverse leakage current	I_R	$V_R = V_R$ rated	-	-	50	μA
		$T_J = 150\text{ °C}, V_R = V_R$ rated	-	-	2	mA
Junction capacitance	C_T	$V_R = 200\text{ V}$	-	89	-	pF
Series inductance	L_S	Measured lead to lead 5 mm from package body	-	3.5	-	nH



DYNAMIC RECOVERY CHARACTERISTICS (T _J = 25 °C unless otherwise specified)							
PARAMETER	SYMBOL	TEST CONDITIONS		MIN.	TYP.	MAX.	UNITS
Reverse recovery time	t _{rr}	I _F = 1.0 A, di _F /dt = 200 A/μs, V _R = 30 V		-	-	35	ns
		T _J = 25 °C	I _F = 80 A V _R = 160 V di _F /dt = 200 A/μs	-	32	-	
		T _J = 125 °C		-	52	-	
Peak recovery current	I _{RRM}	T _J = 25 °C	I _F = 80 A V _R = 160 V di _F /dt = 200 A/μs	-	4.4	-	A
		T _J = 125 °C		-	8.8	-	
Reverse recovery charge	Q _{rr}	T _J = 25 °C	I _F = 80 A V _R = 160 V di _F /dt = 200 A/μs	-	70	-	nC
		T _J = 125 °C		-	240	-	

THERMAL - MECHANICAL SPECIFICATIONS							
PARAMETER	SYMBOL	TEST CONDITIONS		MIN.	TYP.	MAX.	UNITS
Thermal resistance, junction to case	R _{thJC}			-	-	0.70	°C/W
Thermal resistance, junction to heatsink	R _{thCS}	Mounting surface, flat, smooth and greased		-	0.2	-	
Weight				-	-	5.02	g
				-	0.18	-	oz.
Mounting torque				1.2 (10)	-	2.4 (20)	N · m (lbf · in)
Marking device		Case style PowerTab®		80EBU02			

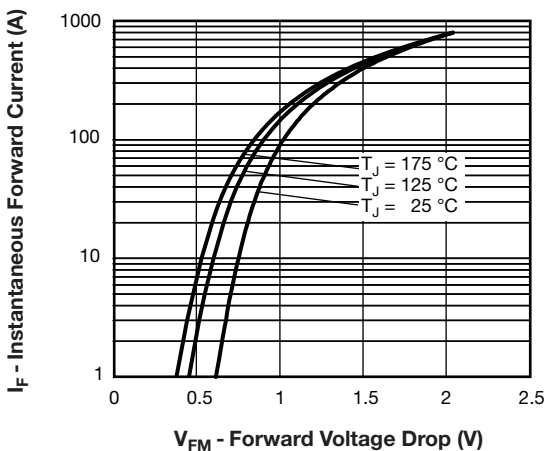

Fig. 1 - Maximum Forward Voltage Drop Characteristics

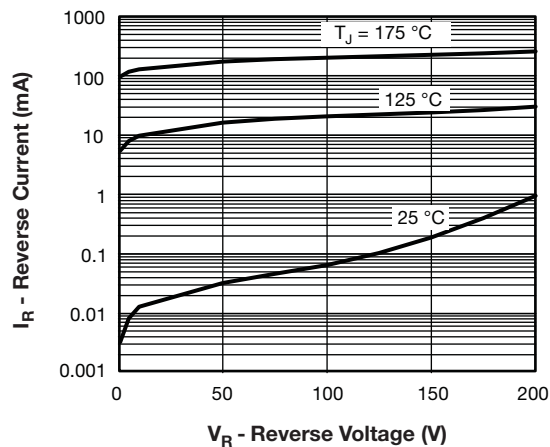

Fig. 2 - Typical Values of Reverse Current vs. Reverse Voltage

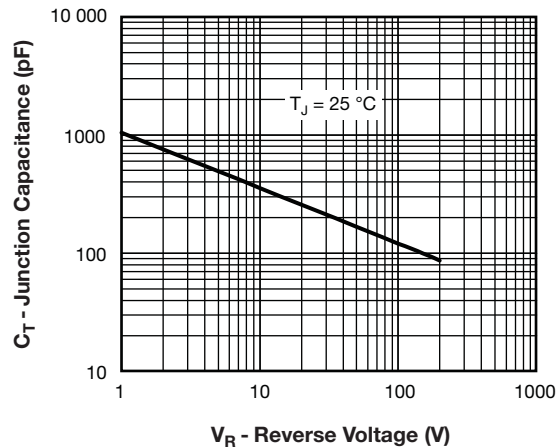

Fig. 3 - Typical Junction Capacitance vs. Reverse Voltage

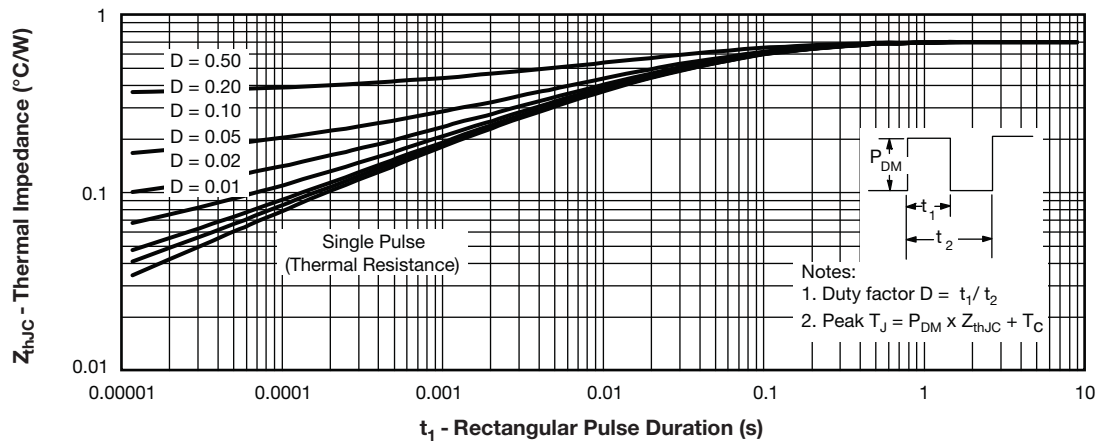

Fig. 4 - Maximum Thermal Impedance Z_{thJC} Characteristics

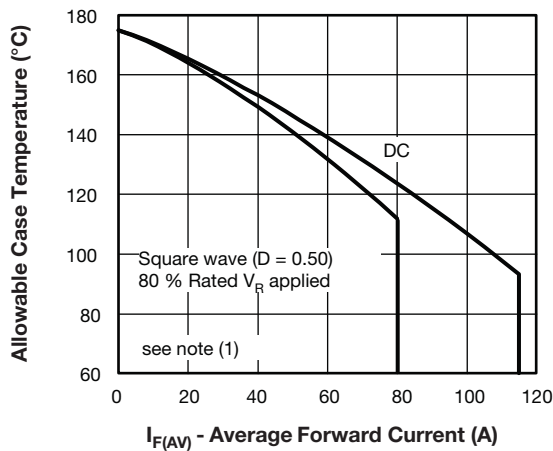

Fig. 5 - Maximum Allowable Case Temperature vs. Average Forward Current

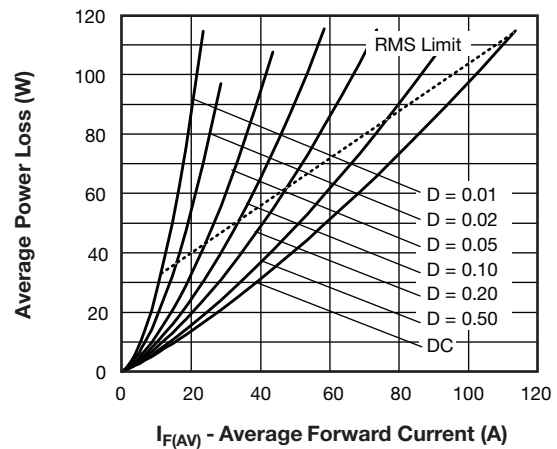

Fig. 6 - Forward Power Loss Characteristics

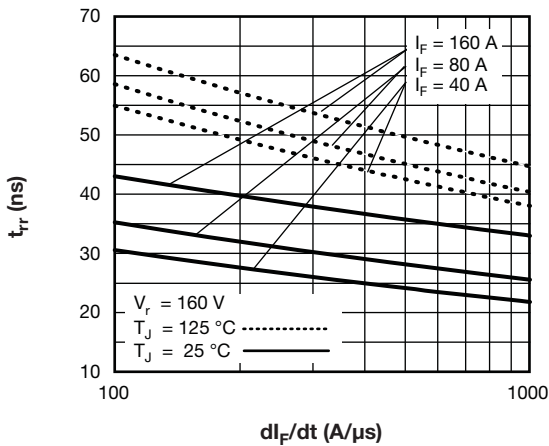

Fig. 7 - Typical Reverse Recovery Time vs. di_F/dt

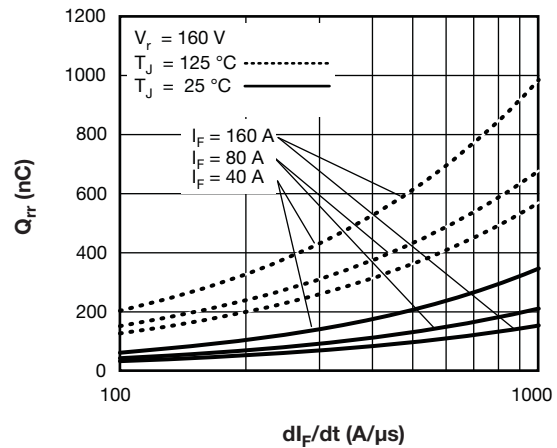

Fig. 8 - Typical Stored Charge vs. di_F/dt

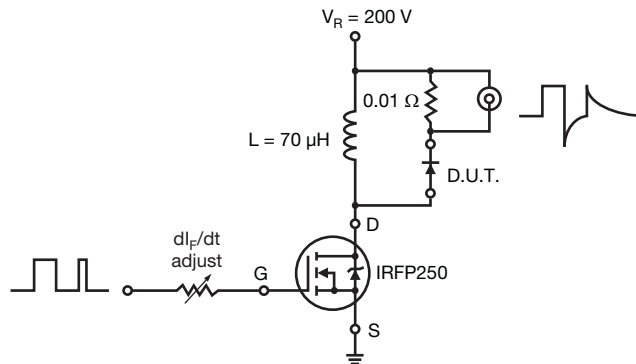
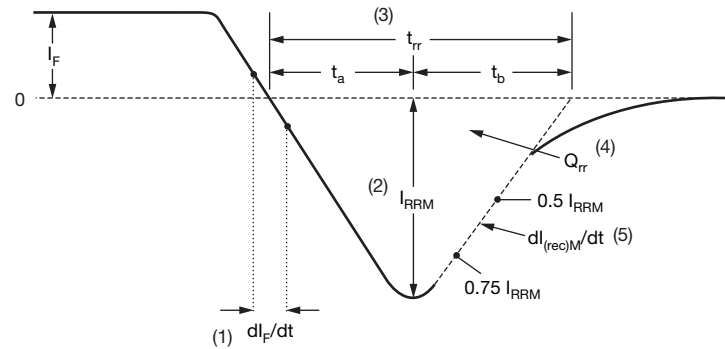

Fig. 9 - Reverse Recovery Parameter Test Circuit

Note

- (1) Formula used: $T_C = T_J - (Pd + Pd_{REV}) \times R_{thJC}$;
- Pd = Forward power loss = $I_{F(AV)} \times V_{FM}$ at $(I_{F(AV)}/D)$ (see fig. 6);
- Pd_{REV} = Inverse power loss = $V_{R1} \times I_R (1 - D)$; I_R at $V_{R1} = 80\%$ rated V_R



(1) di_F/dt - rate of change of current through zero crossing

(2) I_{RRM} - peak reverse recovery current

(3) t_{rr} - reverse recovery time measured from zero crossing point of negative going I_F to point where a line passing through $0.75 I_{RRM}$ and $0.50 I_{RRM}$ extrapolated to zero current.

(4) Q_{rr} - area under curve defined by t_{rr} and I_{RRM}

$$Q_{rr} = \frac{t_{rr} \times I_{RRM}}{2}$$

(5) $di_{(rec)M}/dt$ - peak rate of change of current during t_b portion of t_{rr}

Fig. 10 - Reverse Recovery Waveform and Definitions

ORDERING INFORMATION TABLE

Device code	VS-	80	E	B	U	02
	1	2	3	4	5	6
	1	2	3	4	5	6
	1	2	3	4	5	6
	1	2	3	4	5	6
	1	2	3	4	5	6
	1	2	3	4	5	6

- 1** - Vishay Semiconductors product
- 2** - Current rating (80 = 80 A)
- 3** - Single diode
- 4** - PowerTab® (ultrafast/hyperfast only)
- 5** - Ultrafast recovery
- 6** - Voltage rating (02 = 200 V)

LINKS TO RELATED DOCUMENTS	
Dimensions	www.vishay.com/doc?95240
Part marking information	www.vishay.com/doc?95370
Application note	www.vishay.com/doc?95179



PowerTab®

DIMENSIONS in millimeters (inches)





Disclaimer

ALL PRODUCT, PRODUCT SPECIFICATIONS AND DATA ARE SUBJECT TO CHANGE WITHOUT NOTICE TO IMPROVE RELIABILITY, FUNCTION OR DESIGN OR OTHERWISE.

Vishay Intertechnology, Inc., its affiliates, agents, and employees, and all persons acting on its or their behalf (collectively, "Vishay"), disclaim any and all liability for any errors, inaccuracies or incompleteness contained in any datasheet or in any other disclosure relating to any product.

Vishay makes no warranty, representation or guarantee regarding the suitability of the products for any particular purpose or the continuing production of any product. To the maximum extent permitted by applicable law, Vishay disclaims (i) any and all liability arising out of the application or use of any product, (ii) any and all liability, including without limitation special, consequential or incidental damages, and (iii) any and all implied warranties, including warranties of fitness for particular purpose, non-infringement and merchantability.

Statements regarding the suitability of products for certain types of applications are based on Vishay's knowledge of typical requirements that are often placed on Vishay products in generic applications. Such statements are not binding statements about the suitability of products for a particular application. It is the customer's responsibility to validate that a particular product with the properties described in the product specification is suitable for use in a particular application. Parameters provided in datasheets and / or specifications may vary in different applications and performance may vary over time. All operating parameters, including typical parameters, must be validated for each customer application by the customer's technical experts. Product specifications do not expand or otherwise modify Vishay's terms and conditions of purchase, including but not limited to the warranty expressed therein.

Except as expressly indicated in writing, Vishay products are not designed for use in medical, life-saving, or life-sustaining applications or for any other application in which the failure of the Vishay product could result in personal injury or death. Customers using or selling Vishay products not expressly indicated for use in such applications do so at their own risk. Please contact authorized Vishay personnel to obtain written terms and conditions regarding products designed for such applications.

No license, express or implied, by estoppel or otherwise, to any intellectual property rights is granted by this document or by any conduct of Vishay. Product names and markings noted herein may be trademarks of their respective owners.

Mouser Electronics

Authorized Distributor

Click to View Pricing, Inventory, Delivery & Lifecycle Information:

[Vishay:](#)

[VS-80EBU02](#)