

1.1 nV/ $\sqrt{\text{Hz}}$ Noise, Low Power, Precision Operational Amplifier

Check for Samples: [OPA2211-HT](#)

FEATURES

- Low Voltage Noise: 1.1 nV/ $\sqrt{\text{Hz}}$ at 1 kHz
- Input Voltage Noise:
80 nV_{PP} (0.1 Hz to 10 Hz)
- THD+N: –136dB (G = 1, f = 1 kHz)
- Offset Voltage: 350 μV (max)
- Offset Voltage Drift: 0.35 $\mu\text{V}/^\circ\text{C}$ (typ)
- Low Supply Current: 6 mA/Ch (max)
- Unity-Gain Stable
- Gain Bandwidth Product:
80 MHz (G = 100)
45 MHz (G = 1)
- Slew Rate: 27 V/ μs
- 16-Bit Settling: 700 ns
- Wide Supply Range:
 $\pm 2.25\text{ V}$ to $\pm 18\text{ V}$, 4.5 V to 36 V
- Rail-to-rail output
- Output current: 30 mA

APPLICATIONS

- Down-Hole Drilling
- High Temperature Environments

SUPPORTS EXTREME TEMPERATURE APPLICATIONS

- Controlled Baseline
- One Assembly/Test Site
- One Fabrication Site
- Available in Extreme ($-55^\circ\text{C}/150^\circ\text{C}$) Temperature Range ⁽¹⁾
- Extended Product Life Cycle
- Extended Product-Change Notification
- Product Traceability
- Texas Instruments high temperature products utilize highly optimized silicon (die) solutions with design and process enhancements to maximize performance over extended temperatures.

(1) Custom temperature ranges available

DESCRIPTION

The OPA2211 is a precision operational amplifier that achieves very low 1.1 nV/ $\sqrt{\text{Hz}}$ noise density with a supply current of only 3.6 mA. This device also offers rail-to-rail output swing, which maximizes dynamic range.

The extremely low voltage and low current noise, high speed, and wide output swing of the OPA2211 make this device an excellent choice as a loop filter amplifier in PLL applications.

In precision data acquisition applications, the OPA2211 provides 700-ns settling time to 16-bit accuracy throughout 10-V output swings. This ac performance, combined with only 240- μV of offset and 0.35- $\mu\text{V}/^\circ\text{C}$ of drift over temperature, makes the OPA2211 ideal for driving high-precision 16-bit analog-to-digital converters (ADCs) or buffering the output of high-resolution digital-to-analog converters (DACs).

The OPA2211 is specified over a wide dual-power supply range of $\pm 2.25\text{ V}$ to $\pm 18\text{ V}$, or for single-supply operation from 4.5 V to 36 V.

This op amp is specified from $T_J = -55^\circ\text{C}$ to 150°C .



Please be aware that an important notice concerning availability, standard warranty, and use in critical applications of Texas Instruments semiconductor products and disclaimers thereto appears at the end of this data sheet.

All trademarks are the property of their respective owners.

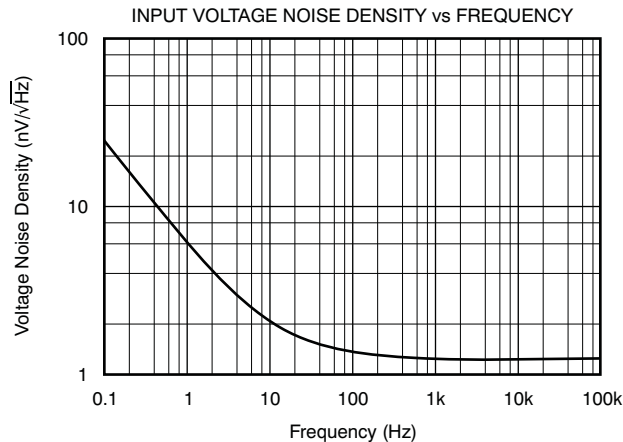
**Table 1. ORDERING INFORMATION⁽¹⁾**

T_J	PACKAGE	ORDERABLE PART NUMBER	TOP-SIDE MARKING
-55°C to 150°C	PWP	OPA2211SPWP	OP2211S

(1) For the most current package and ordering information, see the Package Option Addendum at the end of this document, or see the TI Web site at www.ti.com.



This integrated circuit can be damaged by ESD. Texas Instruments recommends that all integrated circuits be handled with appropriate precautions. Failure to observe proper handling and installation procedures can cause damage.

ESD damage can range from subtle performance degradation to complete device failure. Precision integrated circuits may be more susceptible to damage because very small parametric changes could cause the device not to meet its published specifications.

ABSOLUTE MAXIMUM RATINGS⁽¹⁾

Over operating free-air temperature range (unless otherwise noted).

	VALUE	UNIT	
Supply Voltage	$V_S = (V_+) - (V_-)$	40	V
Input Voltage		$(V_-) - 0.5$ to $(V_+) + 0.5$	V
Input Current (Any pin except power-supply pins)		± 10	mA
Output Short-Circuit ⁽²⁾		Continuous	
Storage Temperature, (T_S)		-65 to +165	°C
Junction Temperature, (T_J)		-55 to +165	°C
ESD Ratings	Human Body Model (HBM)	3000	V
	Charged Device Model (CDM)	1000	V

- (1) Stresses above these ratings may cause permanent damage. Exposure to absolute maximum conditions for extended periods may degrade device reliability. These are stress ratings only, and functional operation of the device at these or any other conditions beyond those specified is not supported.
- (2) Short-circuit to $V_S/2$ (ground in symmetrical dual supply setups), one amplifier per package.

THERMAL INFORMATION

THERMAL METRIC ⁽¹⁾		OPA2211-HT		UNITS
		PWP		
		20 PINS		
θ_{JA}	Junction-to-ambient thermal resistance ⁽²⁾	41.2		°C/W
θ_{JcTop}	Junction-to-case (top) thermal resistance ⁽³⁾	21.4		
θ_{JB}	Junction-to-board thermal resistance ⁽⁴⁾	23.9		
ψ_{JT}	Junction-to-top characterization parameter ⁽⁵⁾	1.1		
ψ_{JB}	Junction-to-board characterization parameter ⁽⁶⁾	23.7		
θ_{JcBot}	Junction-to-case (bottom) thermal resistance ⁽⁷⁾	1.1		

- (1) For more information about traditional and new thermal metrics, see the *IC Package Thermal Metrics* application report, [SPRA953](#).
- (2) The junction-to-ambient thermal resistance under natural convection is obtained in a simulation on a JEDEC-standard, high-K board, as specified in JESD51-7, in an environment described in JESD51-2a.
- (3) The junction-to-case (top) thermal resistance is obtained by simulating a cold plate test on the package top. No specific JEDEC-standard test exists, but a close description can be found in the ANSI SEMI standard G30-88.
- (4) The junction-to-board thermal resistance is obtained by simulating in an environment with a ring cold plate fixture to control the PCB temperature, as described in JESD51-8.
- (5) The junction-to-top characterization parameter, ψ_{JT} , estimates the junction temperature of a device in a real system and is extracted from the simulation data for obtaining θ_{JA} , using a procedure described in JESD51-2a (sections 6 and 7).
- (6) The junction-to-board characterization parameter, ψ_{JB} , estimates the junction temperature of a device in a real system and is extracted from the simulation data for obtaining θ_{JA} , using a procedure described in JESD51-2a (sections 6 and 7).
- (7) The junction-to-case (bottom) thermal resistance is obtained by simulating a cold plate test on the exposed (power) pad. No specific JEDEC standard test exists, but a close description can be found in the ANSI SEMI standard G30-88.

PIN CONFIGURATION

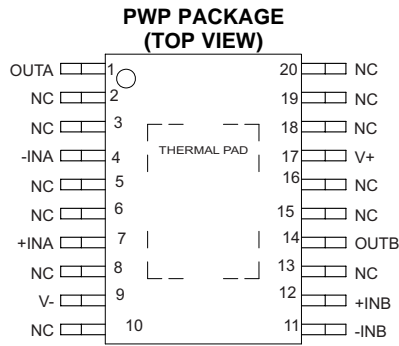

ELECTRICAL CHARACTERISTICS: $V_S = \pm 2.25V$ to $\pm 18V$
BOLDFACE limits apply over the specified temperature range, $T_J = -55^\circ\text{C}$ to $+150^\circ\text{C}$.

 At $T_J = +25^\circ\text{C}$, $R_L = 10\text{k}\Omega$ connected to midsupply, $V_{CM} = V_{OUT} = \text{midsupply}$, unless otherwise noted.

PARAMETER	CONDITIONS	Standard Grade OPA2211			UNIT
		MIN	TYP	MAX	
OFFSET VOLTAGE					
Input Offset Voltage	V_{OS} $V_S = \pm 15V$		± 50	± 175	μV
Over Temperature				± 350	μV
Drift	dV_{OS}/dT		0.35		$\mu\text{V}/^\circ\text{C}$
vs Power Supply	PSRR $V_S = \pm 2.25V$ to $\pm 18V$		0.1	1	$\mu\text{V}/\text{V}$
Over Temperature				3	$\mu\text{V}/\text{V}$
INPUT BIAS CURRENT					
Input Bias Current	I_B $V_{CM} = 0V$		± 60	± 215	nA
Over Temperature				± 350	nA
Offset Current	I_{OS} $V_{CM} = 0V$		± 25	± 120	nA
Over Temperature				± 200	nA
NOISE					
Input Voltage Noise	e_n $f = 0.1\text{Hz}$ to 10Hz		80		nV_{PP}
Input Voltage Noise Density	$f = 10\text{Hz}$		2		$\text{nV}/\sqrt{\text{Hz}}$
	$f = 100\text{Hz}$		1.4		$\text{nV}/\sqrt{\text{Hz}}$
	$f = 1\text{kHz}$		1.1		$\text{nV}/\sqrt{\text{Hz}}$
Input Current Noise Density	I_n $f = 10\text{Hz}$		3.2		$\text{pA}/\sqrt{\text{Hz}}$
	$f = 1\text{kHz}$		1.7		$\text{pA}/\sqrt{\text{Hz}}$
INPUT VOLTAGE RANGE					
Common-Mode Voltage Range ⁽¹⁾	V_{CM} $V_S \geq \pm 5V$	$(V-) + 1.8$		$(V+) - 1.4$	V
	$V_S < \pm 5V$	$(V-) + 2$		$(V+) - 1.4$	V
Common-Mode Rejection Ratio	CMRR $V_S \geq \pm 5V, (V-) + 2V \leq V_{CM} \leq (V+) - 2V$	114	120		dB
	$V_S < \pm 5V, (V-) + 2V \leq V_{CM} \leq (V+) - 2V$	106	120		dB
INPUT IMPEDANCE					
Differential			$20\text{k} \parallel 8$		$\Omega \parallel \text{pF}$
Common-Mode			$10^9 \parallel 2$		$\Omega \parallel \text{pF}$
OPEN-LOOP GAIN					
Open-Loop Voltage Gain	A_{OL} $(V-) + 0.2V \leq V_O \leq (V+) - 0.2V,$ $R_L = 10\text{k}\Omega$	114	130		dB
	A_{OL} $(V-) + 0.6V \leq V_O \leq (V+) - 0.6V,$ $R_L = 600\Omega$	110	114		dB
Over Temperature	A_{OL} $(V-) + 0.6V \leq V_O \leq (V+) - 0.6V,$ $I_O \leq 15\text{mA}$	100			dB
FREQUENCY RESPONSE					
Gain-Bandwidth Product	GBW $G = 100$		80		MHz
	$G = 1$		45		MHz
Slew Rate	SR		27		$\text{V}/\mu\text{s}$
Settling Time, 0.01%	t_S $V_S = \pm 15V, G = -1, 10V$ Step, $C_L = 100\text{pF}$		400		ns
0.0015% (16-bit)	$V_S = \pm 15V, G = -1, 10V$ Step, $C_L = 100\text{pF}$		700		ns
Overload Recovery Time	$G = -10$		500		ns
Total Harmonic Distortion + Noise	THD+N $G = +1, f = 1\text{kHz},$ $V_O = 3V_{RMS}, R_L = 600\Omega$		0.000015		%
			-136		dB

(1) The OPA2211-HT is not intended to be used as a comparator due to its limited differential input range capability. Refer to the [INPUT PROTECTION](#) section of this data sheet.

ELECTRICAL CHARACTERISTICS: $V_S = \pm 2.25V$ to $\pm 18V$ (continued)

BOLDFACE limits apply over the specified temperature range, $T_J = -55^\circ C$ to $+150^\circ C$.

At $T_J = +25^\circ C$, $R_L = 10k\Omega$ connected to midsupply, $V_{CM} = V_{OUT} =$ midsupply, unless otherwise noted.

PARAMETER	CONDITIONS	Standard Grade OPA2211			UNIT
		MIN	TYP	MAX	
OUTPUT					
Voltage Output	V_{OUT} $R_L = 10k\Omega, A_{OL} \geq 114dB$ $R_L = 600\Omega, A_{OL} \geq 110dB$ $I_O < 15mA, A_{OL} \geq 100dB$	(V-) + 0.2 (V-) + 0.6 (V-) + 0.6		(V+) - 0.2 (V+) - 0.6 (V+) - 0.6	V V V
Short-Circuit Current	I_{SC}		+30/-45		mA
Capacitive Load Drive	C_{LOAD}		See Typical Characteristics		pF
Open-Loop Output Impedance	Z_O $f = 1MHz$		5		Ω
POWER SUPPLY					
Specified Voltage	V_S	± 2.25		± 18	V
Quiescent Current (per channel)	I_Q $I_{OUT} = 0A$		3.6	4.5	mA
Over Temperature				6	mA
TEMPERATURE RANGE					
Specified Range	T_A	-55		+150	$^\circ C$
Operating Range	T_A	-55		+150	$^\circ C$

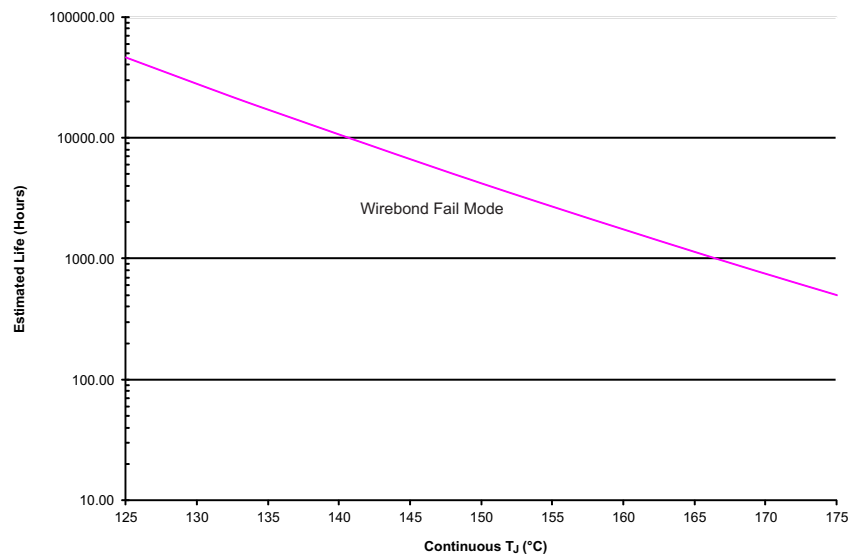

- (1) See Datasheet for Absolute Maximum and Minimum Recommended Operating Conditions.
- (2) Silicon operating life design goal is 10 years at $105^\circ C$ junction temperature (does not include package interconnect life).
- (3) The predicted operating lifetime vs. junction temperature is based on reliability modeling and available qualification data.
- (4) Device is qualified for 1000 hour operation at $150^\circ C$. Device is functional at $175^\circ C$, but at reduced operating life.

Figure 1. OPA2211-HT Wirebond Life Derating Chart

TYPICAL CHARACTERISTICS

At $T_A = +25^\circ\text{C}$, $V_S = \pm 18\text{V}$, and $R_L = 10\text{k}\Omega$, unless otherwise noted.

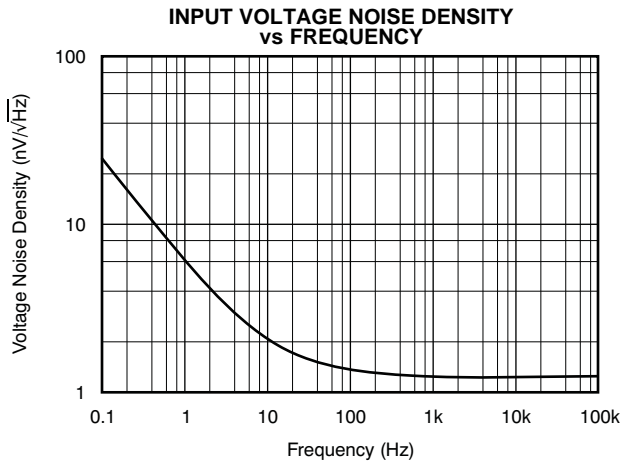

Figure 2.

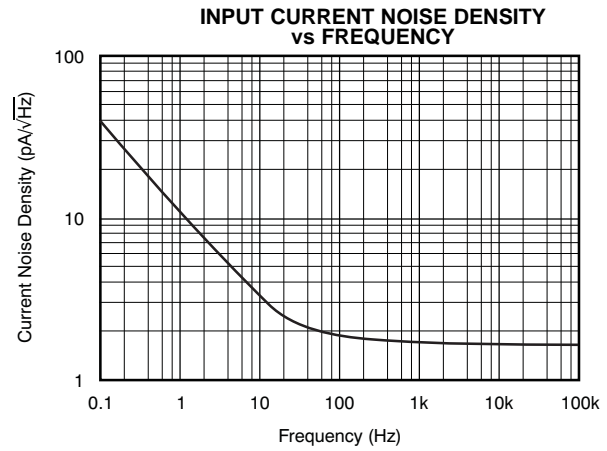

Figure 3.

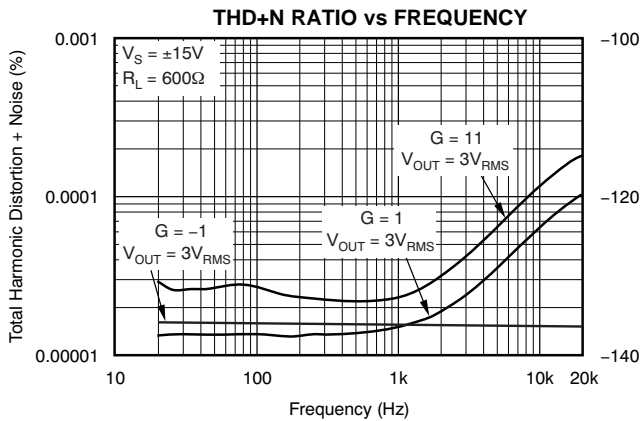

Figure 4.

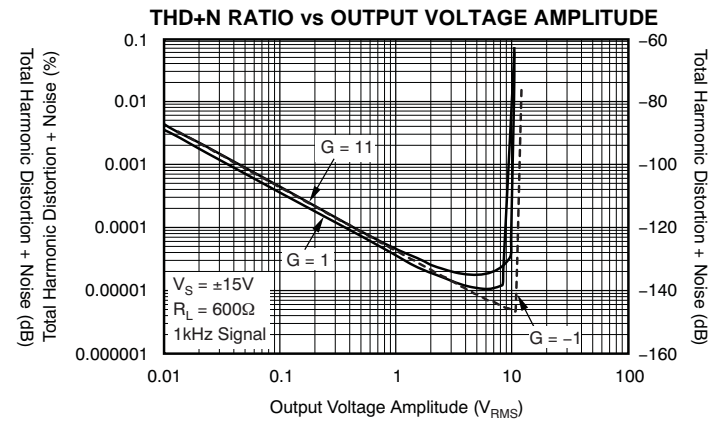

Figure 5.

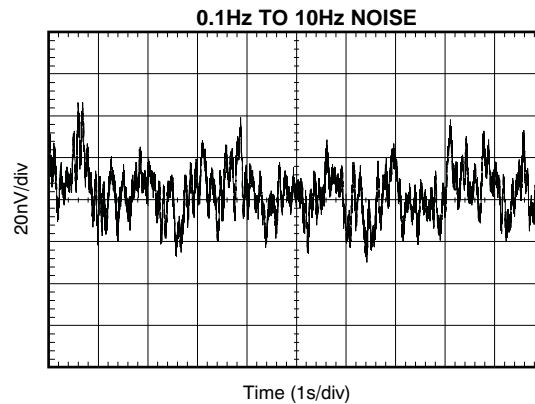

Figure 6.

TYPICAL CHARACTERISTICS (continued)

At $T_A = +25^\circ\text{C}$, $V_S = \pm 18\text{V}$, and $R_L = 10\text{k}\Omega$, unless otherwise noted.

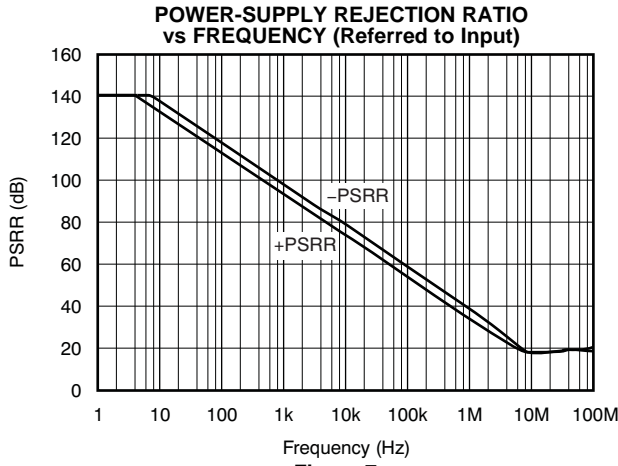

Figure 7.

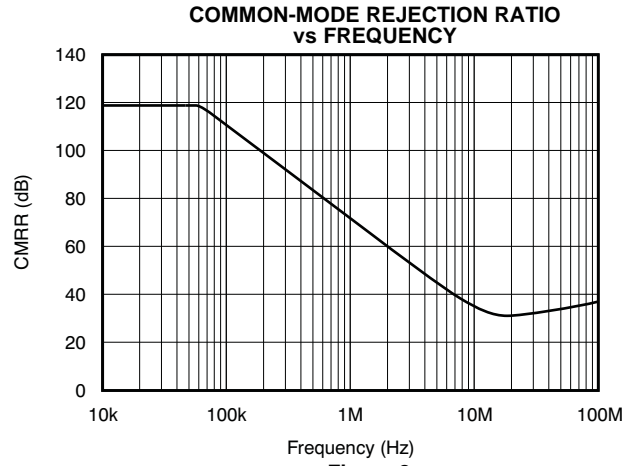

Figure 8.

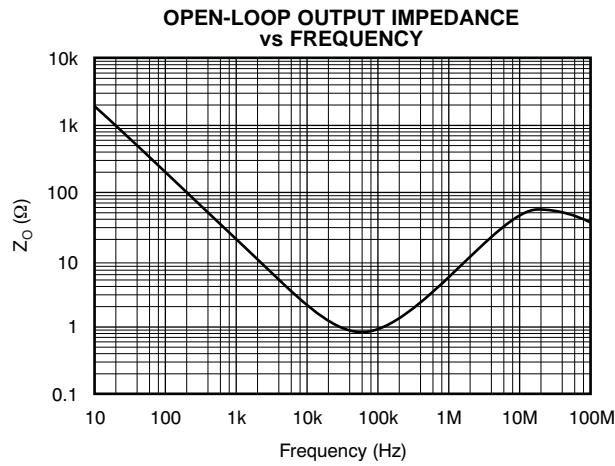

Figure 9.

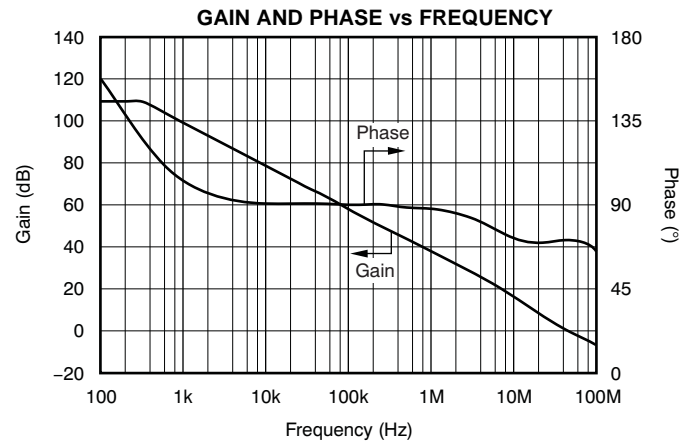

Figure 10.

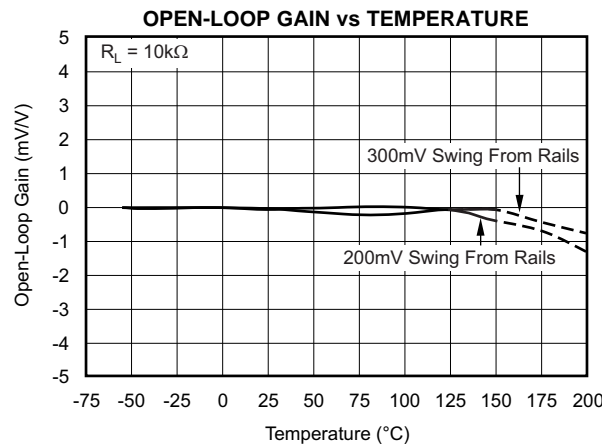
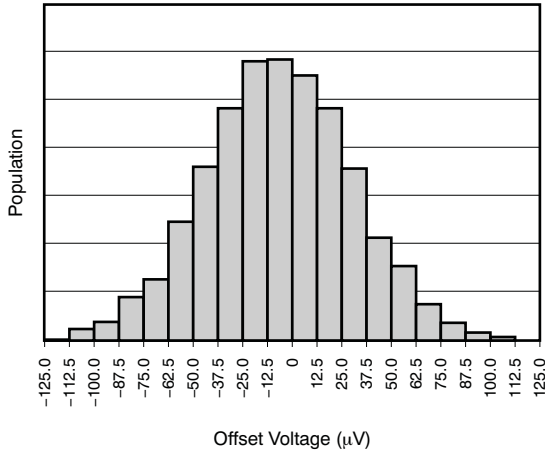

Figure 11.

TYPICAL CHARACTERISTICS (continued)

At $T_A = +25^\circ\text{C}$, $V_S = \pm 18\text{V}$, and $R_L = 10\text{k}\Omega$, unless otherwise noted.

OFFSET VOLTAGE PRODUCTION DISTRIBUTION



Offset Voltage (μV)
Figure 12.

OFFSET VOLTAGE DRIFT PRODUCTION DISTRIBUTION

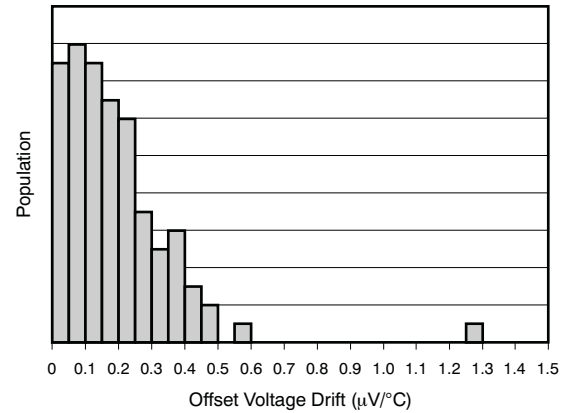

Figure 13.

I_B AND I_{OS} CURRENT vs TEMPERATURE

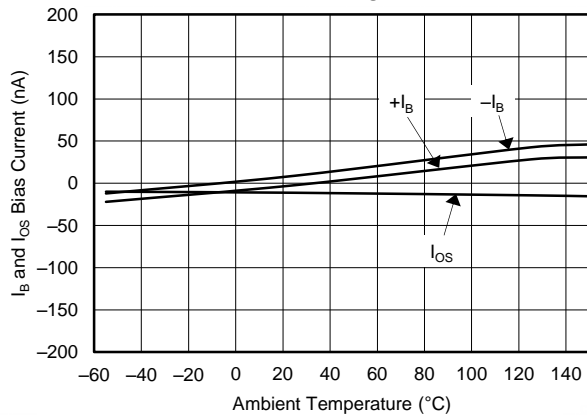

Figure 14.

OFFSET VOLTAGE vs COMMON-MODE VOLTAGE

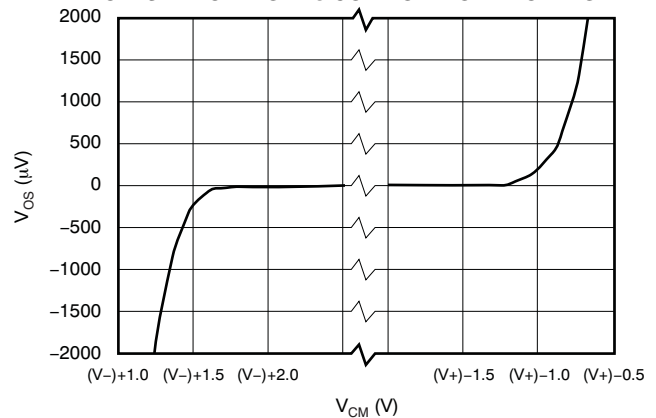

Figure 15.

V_{OS} WARMUP

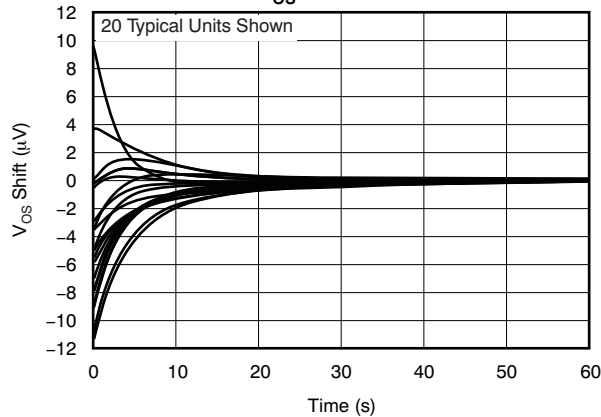

Figure 16.

INPUT OFFSET CURRENT vs SUPPLY VOLTAGE

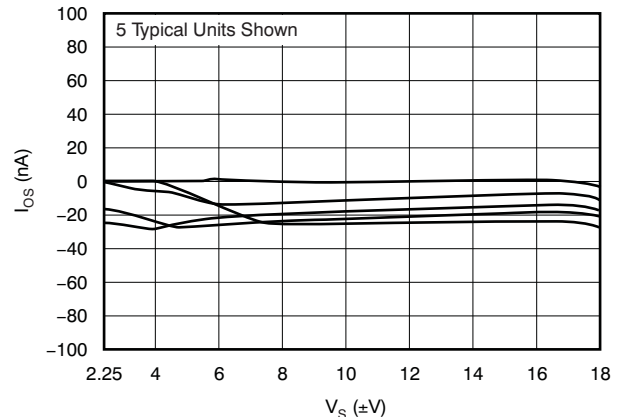

Figure 17.

TYPICAL CHARACTERISTICS (continued)

At $T_A = +25^\circ\text{C}$, $V_S = \pm 18\text{V}$, and $R_L = 10\text{k}\Omega$, unless otherwise noted.

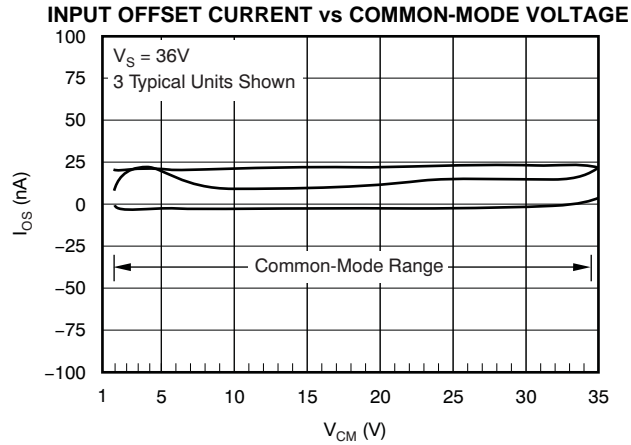

Figure 18.

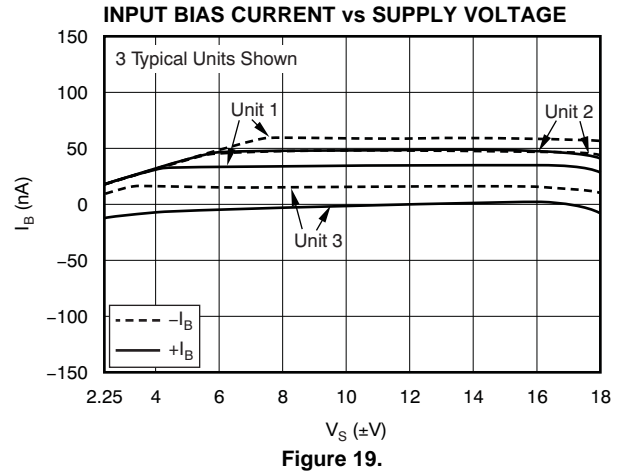

Figure 19.

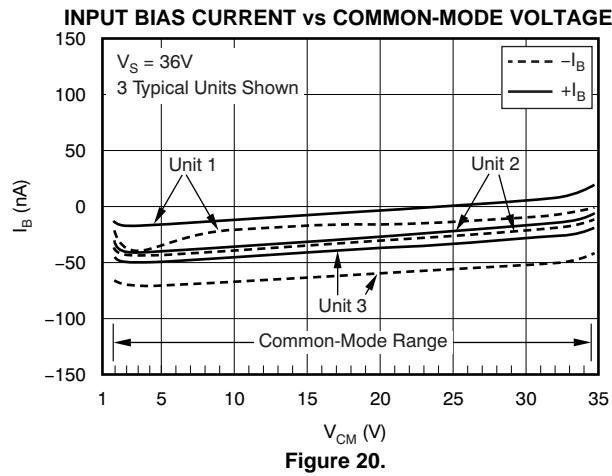

Figure 20.

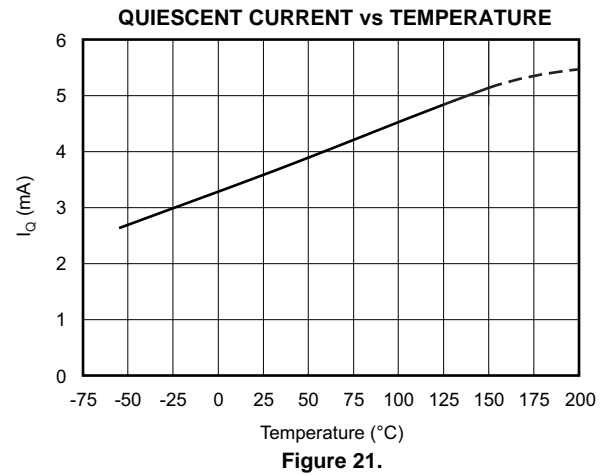

Figure 21.

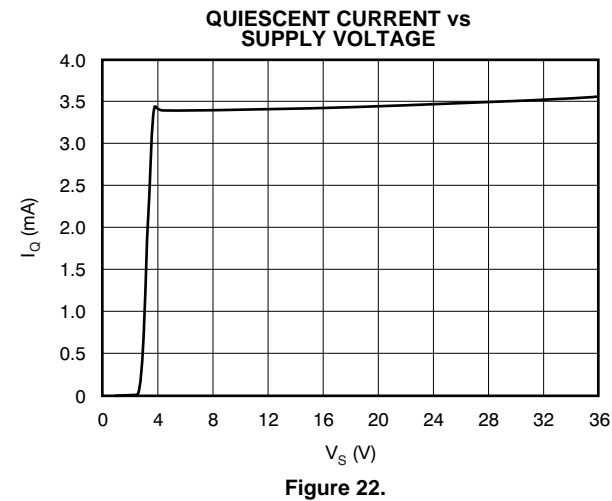

Figure 22.

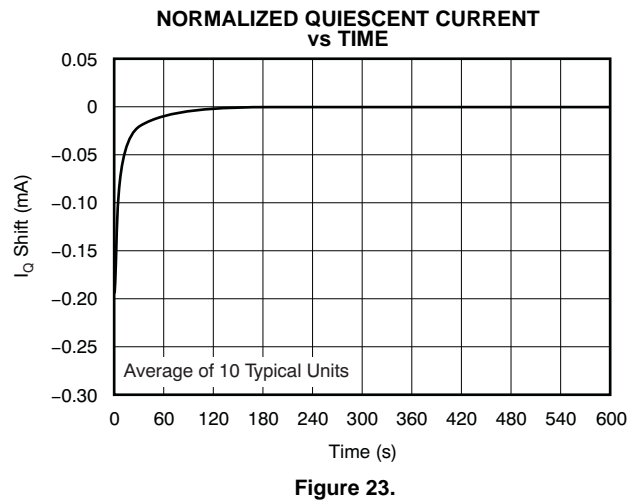

Figure 23.

TYPICAL CHARACTERISTICS (continued)

At $T_A = +25^\circ\text{C}$, $V_S = \pm 18\text{V}$, and $R_L = 10\text{k}\Omega$, unless otherwise noted.

SHORT-CIRCUIT CURRENT vs TEMPERATURE

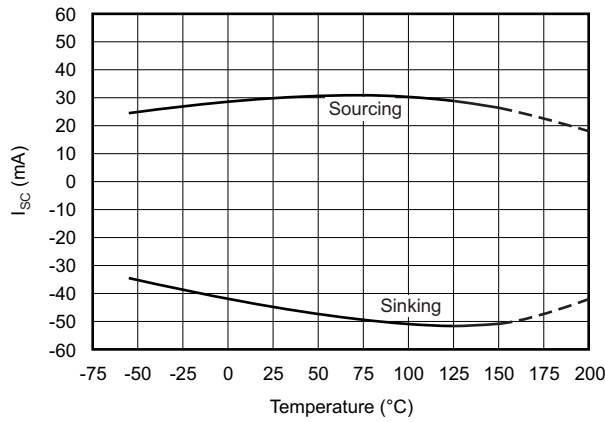

Figure 24.

SMALL-SIGNAL STEP RESPONSE (100mV)

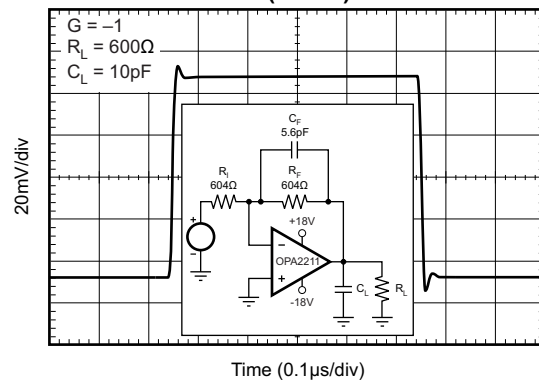

Figure 25.

SMALL-SIGNAL STEP RESPONSE (100mV)

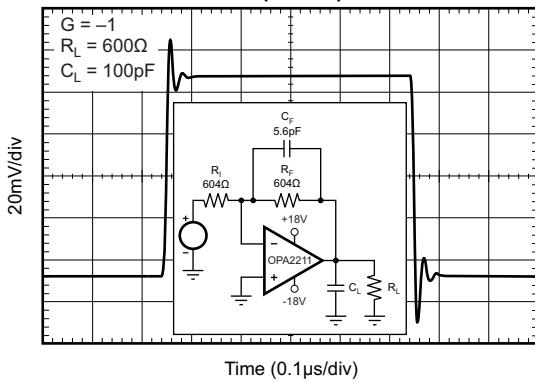

Figure 26.

SMALL-SIGNAL STEP RESPONSE (100mV)

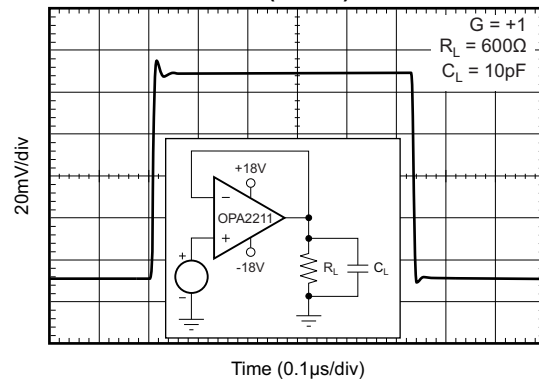

Figure 27.

SMALL-SIGNAL STEP RESPONSE (100mV)

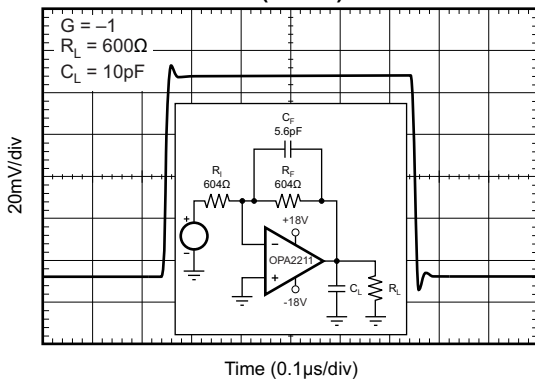

Figure 28.

SMALL-SIGNAL OVERSHOOT vs CAPACITIVE LOAD (100mV Output Step)

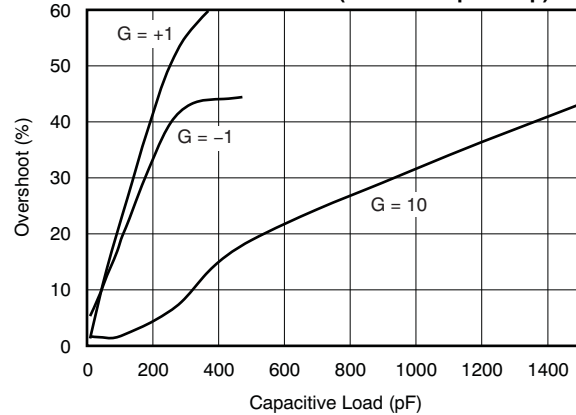
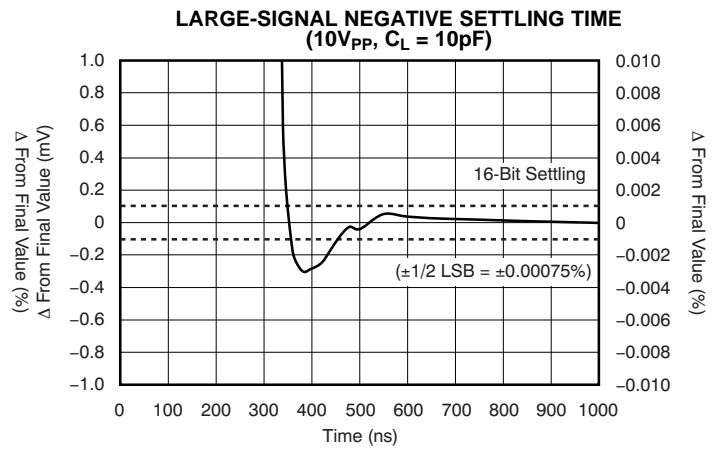
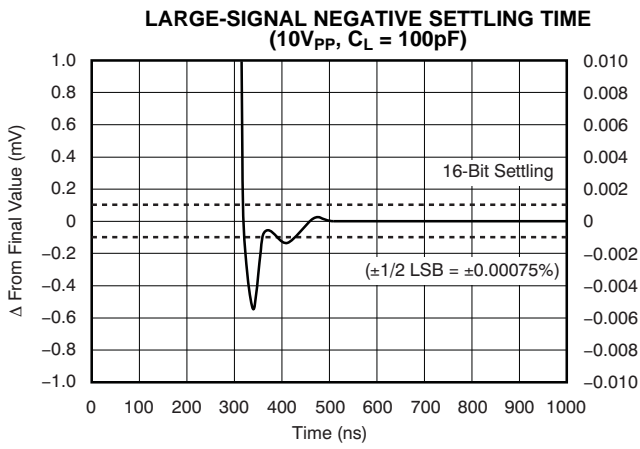
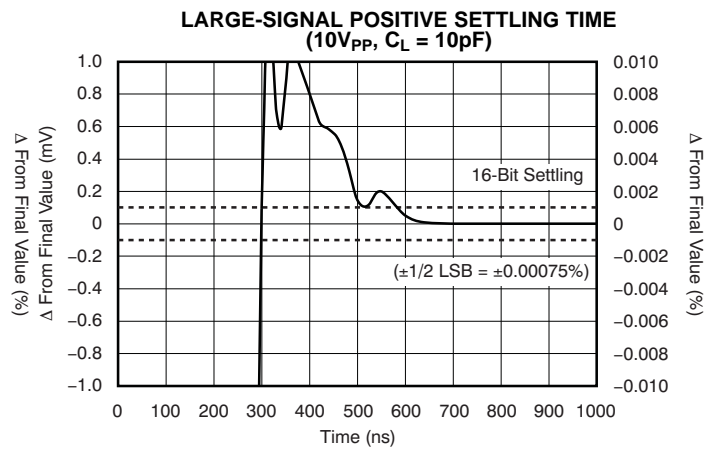
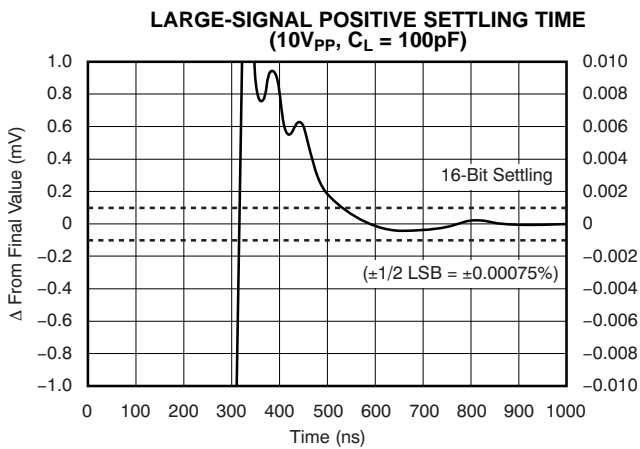
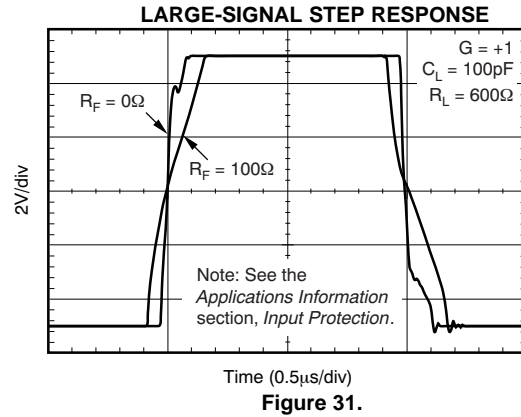
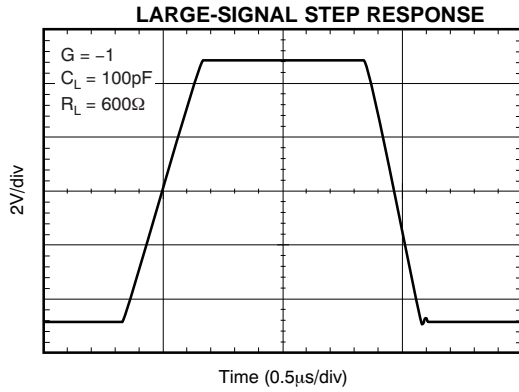

Figure 29.

TYPICAL CHARACTERISTICS (continued)

At $T_A = +25^\circ\text{C}$, $V_S = \pm 18\text{V}$, and $R_L = 10\text{k}\Omega$, unless otherwise noted.



TYPICAL CHARACTERISTICS (continued)

At $T_A = +25^\circ\text{C}$, $V_S = \pm 18\text{V}$, and $R_L = 10\text{k}\Omega$, unless otherwise noted.

NEGATIVE OVERLOAD RECOVERY

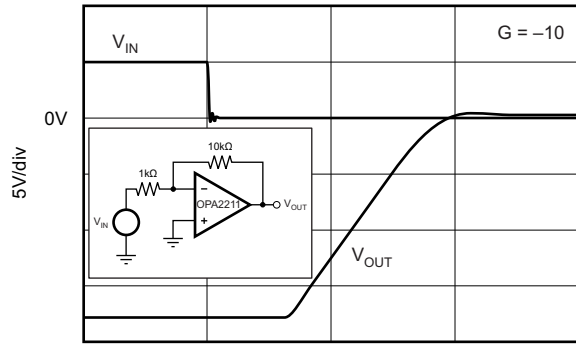

Time (0.5μs/div)
Figure 36.

POSITIVE OVERLOAD RECOVERY

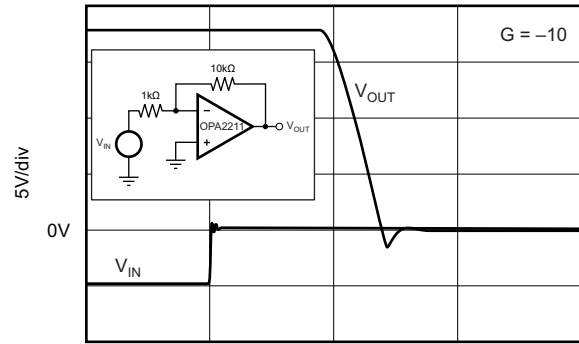

Time (0.5μs/div)
Figure 37.

OUTPUT VOLTAGE vs OUTPUT CURRENT

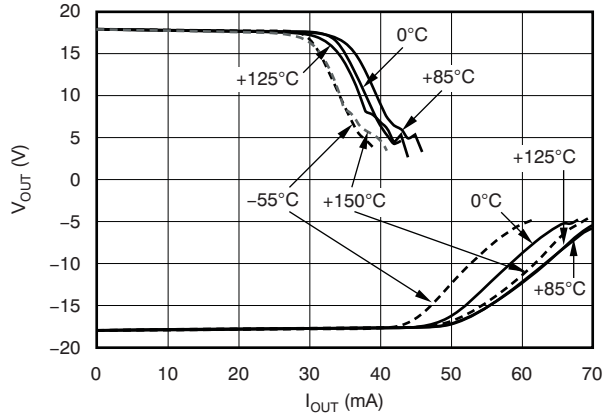

Figure 38.

NO PHASE REVERSAL

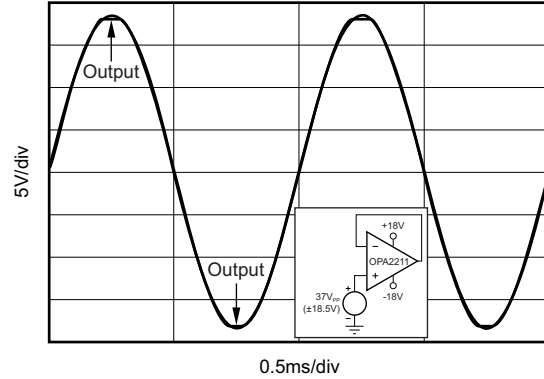

Figure 39.

APPLICATION INFORMATION

The OPA2211 is a unity-gain stable, precision op amp with very low noise. Applications with noisy or high-impedance power supplies require decoupling capacitors close to the device pins. In most cases, 0.1 μ F capacitors are adequate. [Figure 40](#) shows a simplified schematic of the OPA2211. This die uses a SiGe bipolar process and contains 180 transistors.

OPERATING VOLTAGE

OPA2211 series op amps operate from ± 2.25 V to ± 18 V supplies while maintaining excellent performance. The OPA2211 series can operate with as little as +4.5V between the supplies and with up to +36V between the supplies. However, some applications do not require equal positive and

negative output voltage swing. With the OPA2211 series, power-supply voltages do not need to be equal. For example, the positive supply could be set to +25V with the negative supply at -5V or vice-versa.

The common-mode voltage must be maintained within the specified range. In addition, key parameters are assured over the specified temperature range, $T_j = -55^\circ\text{C}$ to $+150^\circ\text{C}$. Parameters that vary significantly with operating voltage or temperature are shown in the [Typical Characteristics](#).

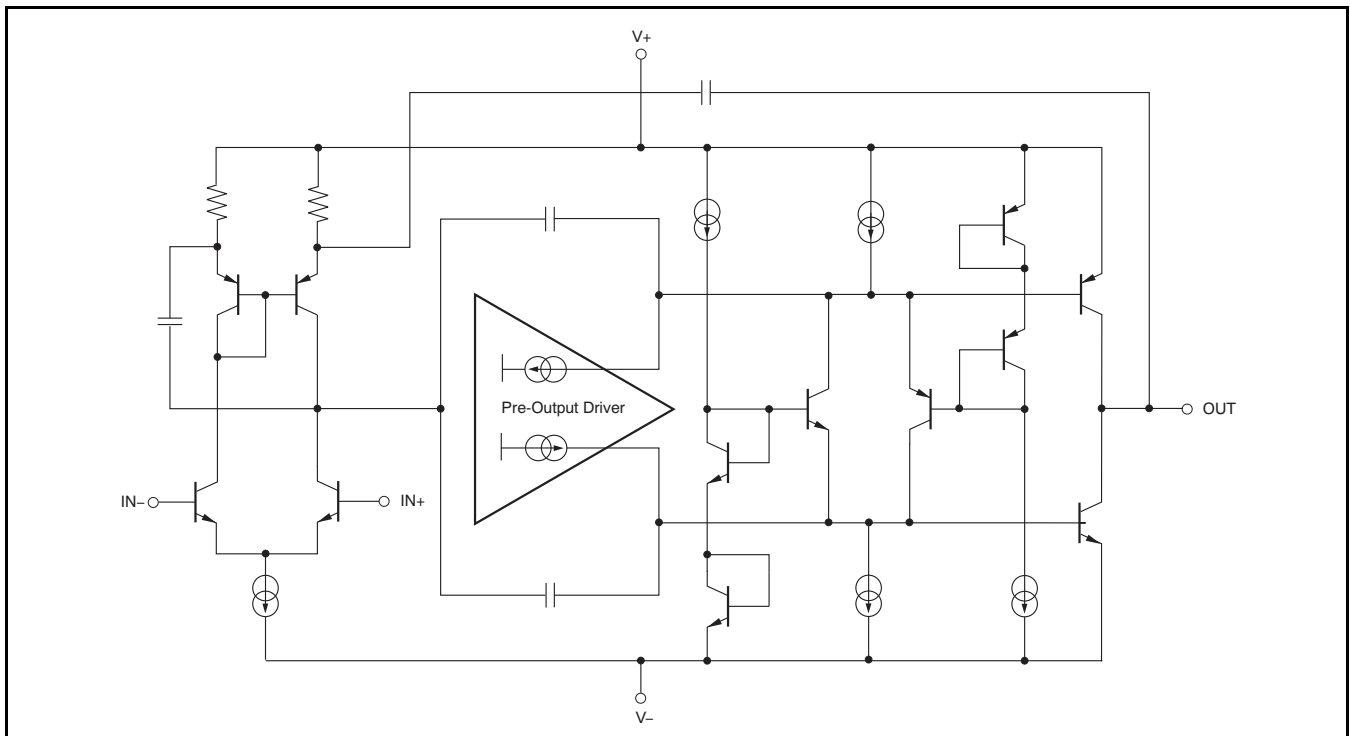

Figure 40. OPA2211 Simplified Schematic

INPUT PROTECTION

The input terminals of the OPA2211 are protected from excessive differential voltage with back-to-back diodes, as shown in [Figure 41](#). In most circuit applications, the input protection circuitry has no consequence. However, in low-gain or $G = 1$ circuits, fast ramping input signals can forward bias these diodes because the output of the amplifier cannot respond rapidly enough to the input ramp. This effect is illustrated in [Figure 31](#) of the Typical Characteristics. If the input signal is fast enough to create this forward bias condition, the input signal current must be limited to 10mA or less. If the input signal current is not inherently limited, an input series resistor can be used to limit the signal input current. This input series resistor degrades the low-noise performance of the OPA2211, and is discussed in the [Noise Performance](#) section of this data sheet. [Figure 41](#) shows an example implementing a current-limiting feedback resistor.

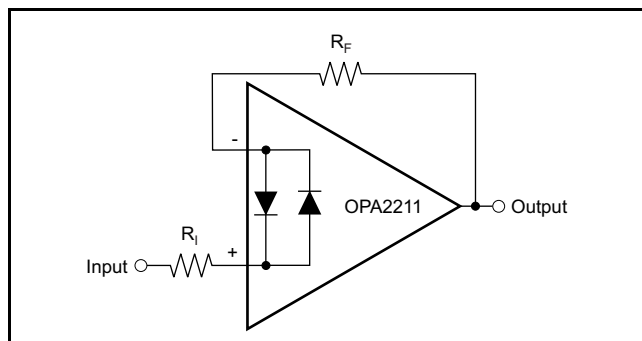

Figure 41. Pulsed Operation

NOISE PERFORMANCE

[Figure 42](#) shows total circuit noise for varying source impedances with the op amp in a unity-gain configuration (no feedback resistor network, and therefore no additional noise contributions). Two different op amps are shown with total circuit noise calculated. The OPA2211 has very low voltage noise, making it ideal for low source impedances (less than 2kΩ). A similar precision op amp, the [OPA227](#), has somewhat higher voltage noise but lower current noise. It provides excellent noise performance at moderate source impedance (10kΩ to 100kΩ). Above 100kΩ, a FET-input op amp such as the [OPA132](#) (very low current noise) may provide improved performance. The equation in [Figure 42](#) is shown for the calculation of the total circuit noise. Note that e_n = voltage noise, i_n = current noise, R_S = source impedance, k = Boltzmann's constant = 1.38×10^{-23} J/K, and T is temperature in K.

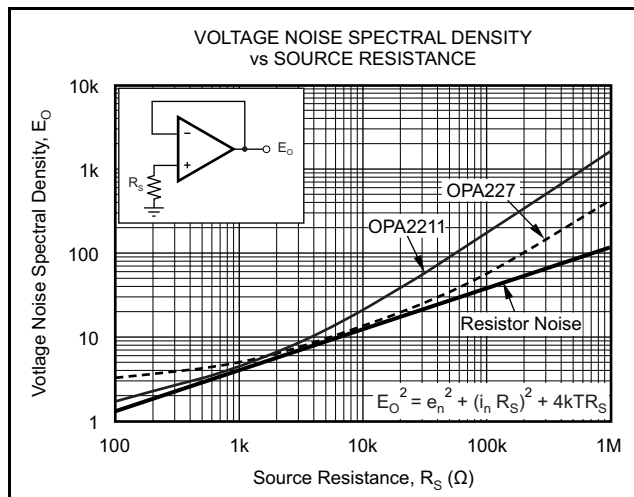

Figure 42. Noise Performance of the OPA2211 and OPA227 in Unity-Gain Buffer Configuration

BASIC NOISE CALCULATIONS

Design of low-noise op amp circuits requires careful consideration of a variety of possible noise contributors: noise from the signal source, noise generated in the op amp, and noise from the feedback network resistors. The total noise of the circuit is the root-sum-square combination of all noise components.

The resistive portion of the source impedance produces thermal noise proportional to the square root of the resistance. This function is plotted in [Figure 42](#). The source impedance is usually fixed; consequently, select the op amp and the feedback resistors to minimize the respective contributions to the total noise.

[Figure 42](#) depicts total noise for varying source impedances with the op amp in a unity-gain configuration (no feedback resistor network, and therefore no additional noise contributions). The operational amplifier itself contributes both a voltage noise component and a current noise component. The voltage noise is commonly modeled as a time-varying component of the offset voltage. The current noise is modeled as the time-varying component of the input bias current and reacts with the source resistance to create a voltage component of noise. Therefore, the lowest noise op amp for a given application depends on the source impedance. For low source impedance, current noise is negligible and voltage noise generally dominates. For high source impedance, current noise may dominate.

illustrates both inverting and noninverting op amp circuit configurations with gain. In circuit configurations with gain, the feedback network resistors also contribute noise. The current noise of the op amp reacts with the feedback resistors to create additional noise components. The feedback resistor values can generally be chosen to make these noise sources negligible. The equations for total noise are shown for both configurations.

TOTAL HARMONIC DISTORTION MEASUREMENTS

OPA2211 series op amps have excellent distortion characteristics. THD + Noise is below 0.0001% ($G = +1$, $V_O = 3V_{RMS}$) throughout the audio frequency range, 20Hz to 20kHz, with a 600Ω load.

The distortion produced by OPA2211 series op amps is below the measurement limit of many commercially available distortion analyzers. However, a special test circuit illustrated in can be used to extend the measurement capabilities.

ELECTRICAL OVERSTRESS

Designers often ask questions about the capability of an operational amplifier to withstand electrical overstress. These questions tend to focus on the device inputs, but may involve the supply voltage pins or even the output pin. Each of these different pin functions have electrical stress limits determined by the voltage breakdown characteristics of the particular semiconductor fabrication process and specific circuits connected to the pin. Additionally, internal electrostatic discharge (ESD) protection is built into these circuits to protect them from accidental ESD events both before and during product assembly.

It is helpful to have a good understanding of this basic ESD circuitry and its relevance to an electrical overstress event. [Figure 43](#) illustrates the ESD circuits contained in the OPA2211 (indicated by the dashed line area). The ESD protection circuitry involves several current-steering diodes connected from the input and output pins and routed back to the internal power-supply lines, where they meet at an absorption device internal to the operational amplifier. This protection circuitry is intended to remain inactive during normal circuit operation.

Op amp distortion can be considered an internal error source that can be referred to the input. shows a circuit that causes the op amp distortion to be 101 times greater than that normally produced by the op amp. The addition of R_3 to the otherwise standard noninverting amplifier configuration alters the feedback factor or noise gain of the circuit. The closed-loop gain is unchanged, but the feedback available for error correction is reduced by a factor of 101, thus extending the resolution by 101. Note that the input signal and load applied to the op amp are the same as with conventional feedback without R_3 . The value of R_3 should be kept small to minimize its effect on the distortion measurements.

Validity of this technique can be verified by duplicating measurements at high gain and/or high frequency where the distortion is within the measurement capability of the test equipment. Measurements for this data sheet were made with an Audio Precision System Two distortion/noise analyzer, which greatly simplifies such repetitive measurements. The measurement technique can, however, be performed with manual distortion measurement instruments.

An ESD event produces a short duration, high-voltage pulse that is transformed into a short duration, high-current pulse as it discharges through a semiconductor device. The ESD protection circuits are designed to provide a current path around the operational amplifier core to prevent it from being damaged. The energy absorbed by the protection circuitry is then dissipated as heat.

When an ESD voltage develops across two or more of the amplifier device pins, current flows through one or more of the steering diodes. Depending on the path that the current takes, the absorption device may activate. The absorption device has a trigger, or threshold voltage, that is above the normal operating voltage of the OPA2211 but below the device breakdown voltage level. Once this threshold is exceeded, the absorption device quickly activates and clamps the voltage across the supply rails to a safe level.

When the operational amplifier connects into a circuit such as that illustrated in [Figure 43](#), the ESD protection components are intended to remain inactive and not become involved in the application circuit operation. However, circumstances may arise where an applied voltage exceeds the operating voltage range of a given pin. Should this condition occur, there is a risk that some of the internal ESD protection circuits may be biased on, and conduct current. Any such current flow occurs through steering diode paths and rarely involves the absorption device.

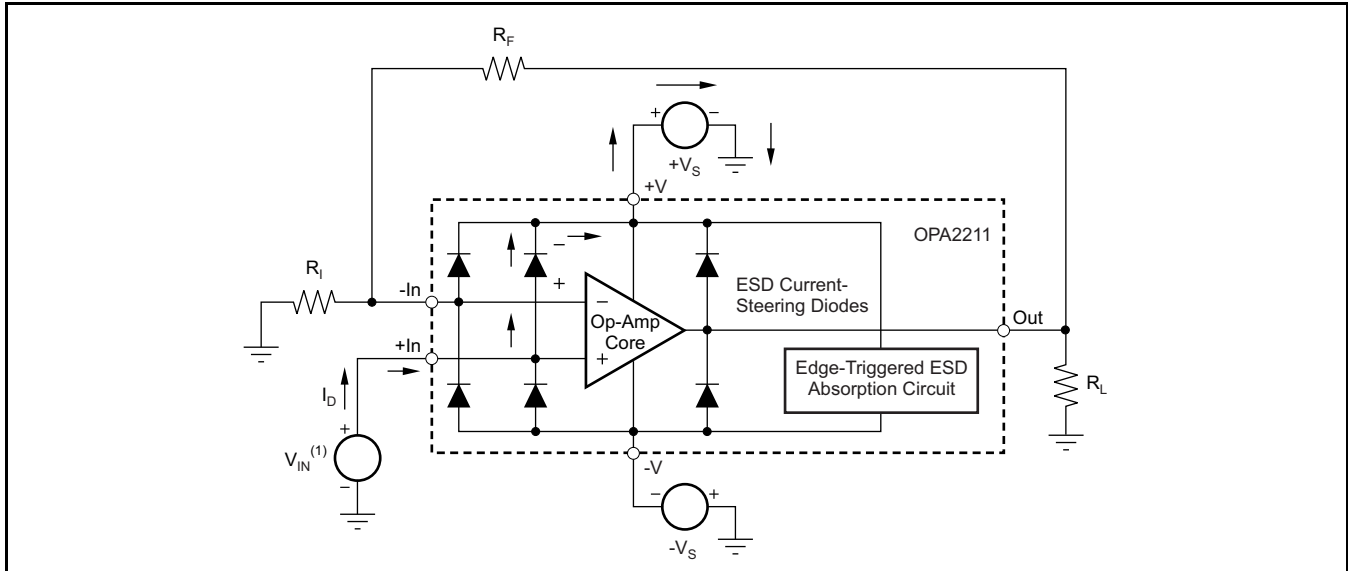

(1) $V_{IN} = +V_S + 500\text{mV}$.

Figure 43. Equivalent Internal ESD Circuitry and Its Relation to a Typical Circuit Application

Figure 43 depicts a specific example where the input voltage, V_{IN} , exceeds the positive supply voltage ($+V_S$) by 500mV or more. Much of what happens in the circuit depends on the supply characteristics. If $+V_S$ can sink the current, one of the upper input steering diodes conducts and directs current to $+V_S$. Excessively high current levels can flow with increasingly higher V_{IN} . As a result, the datasheet specifications recommend that applications limit the input current to 10mA.

If the supply is not capable of sinking the current, V_{IN} may begin sourcing current to the operational amplifier, and then take over as the source of positive supply voltage. The danger in this case is that the voltage can rise to levels that exceed the operational amplifier absolute maximum ratings. In extreme but rare cases, the absorption device triggers on while $+V_S$ and $-V_S$ are applied. If this event happens, a

direct current path is established between the $+V_S$ and $-V_S$ supplies. The power dissipation of the absorption device is quickly exceeded, and the extreme internal heating destroys the operational amplifier.

Another common question involves what happens to the amplifier if an input signal is applied to the input while the power supplies $+V_S$ and/or $-V_S$ are at 0V. Again, it depends on the supply characteristic while at 0V, or at a level below the input signal amplitude. If the supplies appear as high impedance, then the operational amplifier supply current may be supplied by the input source via the current steering diodes. This state is not a normal bias condition; the amplifier most likely will not operate normally. If the supplies are low impedance, then the current through the steering diodes can become quite high. The current level depends on the ability of the input source to deliver current, and any resistance in the input path.

PACKAGING INFORMATION

Orderable Device	Status (1)	Package Type	Package Drawing	Pins	Package Qty	Eco Plan (2)	Lead/Ball Finish (6)	MSL Peak Temp (3)	Op Temp (°C)	Device Marking (4/5)	Samples
OPA2211SPWP	ACTIVE	HTSSOP	PWP	20	70	Green (RoHS & no Sb/Br)	NIPDAU	Level-3-260C-168 HR	-55 to 150	OP2211S	

(1) The marketing status values are defined as follows:

ACTIVE: Product device recommended for new designs.

LIFEBUY: TI has announced that the device will be discontinued, and a lifetime-buy period is in effect.

NRND: Not recommended for new designs. Device is in production to support existing customers, but TI does not recommend using this part in a new design.

PREVIEW: Device has been announced but is not in production. Samples may or may not be available.

OBSELETE: TI has discontinued the production of the device.

(2) **RoHS:** TI defines "RoHS" to mean semiconductor products that are compliant with the current EU RoHS requirements for all 10 RoHS substances, including the requirement that RoHS substance do not exceed 0.1% by weight in homogeneous materials. Where designed to be soldered at high temperatures, "RoHS" products are suitable for use in specified lead-free processes. TI may reference these types of products as "Pb-Free".

RoHS Exempt: TI defines "RoHS Exempt" to mean products that contain lead but are compliant with EU RoHS pursuant to a specific EU RoHS exemption.

Green: TI defines "Green" to mean the content of Chlorine (Cl) and Bromine (Br) based flame retardants meet JS709B low halogen requirements of <=1000ppm threshold. Antimony trioxide based flame retardants must also meet the <=1000ppm threshold requirement.

(3) MSL, Peak Temp. - The Moisture Sensitivity Level rating according to the JEDEC industry standard classifications, and peak solder temperature.

(4) There may be additional marking, which relates to the logo, the lot trace code information, or the environmental category on the device.

(5) Multiple Device Markings will be inside parentheses. Only one Device Marking contained in parentheses and separated by a "~" will appear on a device. If a line is indented then it is a continuation of the previous line and the two combined represent the entire Device Marking for that device.

(6) Lead/Ball Finish - Orderable Devices may have multiple material finish options. Finish options are separated by a vertical ruled line. Lead/Ball Finish values may wrap to two lines if the finish value exceeds the maximum column width.

Important Information and Disclaimer:The information provided on this page represents TI's knowledge and belief as of the date that it is provided. TI bases its knowledge and belief on information provided by third parties, and makes no representation or warranty as to the accuracy of such information. Efforts are underway to better integrate information from third parties. TI has taken and continues to take reasonable steps to provide representative and accurate information but may not have conducted destructive testing or chemical analysis on incoming materials and chemicals. TI and TI suppliers consider certain information to be proprietary, and thus CAS numbers and other limited information may not be available for release.

In no event shall TI's liability arising out of such information exceed the total purchase price of the TI part(s) at issue in this document sold by TI to Customer on an annual basis.

OTHER QUALIFIED VERSIONS OF OPA2211-HT :

- Enhanced Product: [OPA2211-EP](#)

NOTE: Qualified Version Definitions:

- Enhanced Product - Supports Defense, Aerospace and Medical Applications

MECHANICAL DATA

PWP (R-PDSO-G20)

PowerPAD™ PLASTIC SMALL OUTLINE



4073225-4/1 05/11

- NOTES:
- All linear dimensions are in millimeters.
 - This drawing is subject to change without notice.
 - Body dimensions do not include mold flash or protrusions. Mold flash and protrusion shall not exceed 0.15 per side.
 - This package is designed to be soldered to a thermal pad on the board. Refer to Technical Brief, PowerPad Thermally Enhanced Package, Texas Instruments Literature No. SLMA002 for information regarding recommended board layout. This document is available at www.ti.com <<http://www.ti.com>>.
 - See the additional figure in the Product Data Sheet for details regarding the exposed thermal pad features and dimensions.
 - Falls within JEDEC MO-153

PowerPAD is a trademark of Texas Instruments.

PWP (R-PDSO-G20) PowerPAD™ SMALL PLASTIC OUTLINE

THERMAL INFORMATION

This PowerPAD™ package incorporates an exposed thermal pad that is designed to be attached to a printed circuit board (PCB). The thermal pad must be soldered directly to the PCB. After soldering, the PCB can be used as a heatsink. In addition, through the use of thermal vias, the thermal pad can be attached directly to the appropriate copper plane shown in the electrical schematic for the device, or alternatively, can be attached to a special heatsink structure designed into the PCB. This design optimizes the heat transfer from the integrated circuit (IC).

For additional information on the PowerPAD package and how to take advantage of its heat dissipating abilities, refer to Technical Brief, PowerPAD Thermally Enhanced Package, Texas Instruments Literature No. SLMA002 and Application Brief, PowerPAD Made Easy, Texas Instruments Literature No. SLMA004. Both documents are available at www.ti.com.

The exposed thermal pad dimensions for this package are shown in the following illustration.

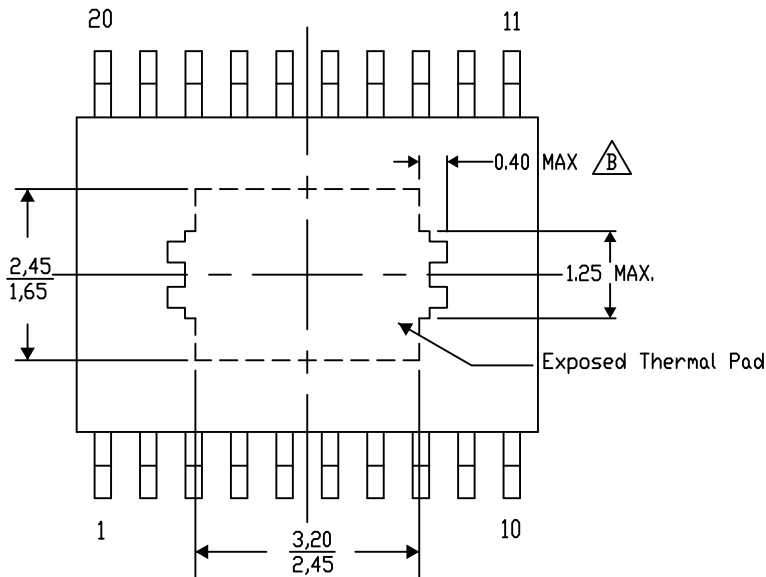

Top View

Exposed Thermal Pad Dimensions

4206332-18/AO 01/16

NOTE: A. All linear dimensions are in millimeters
 B. Exposed tie strap features may not be present.

PWP (R-PDSO-G20)

PowerPAD™ PLASTIC SMALL OUTLINE

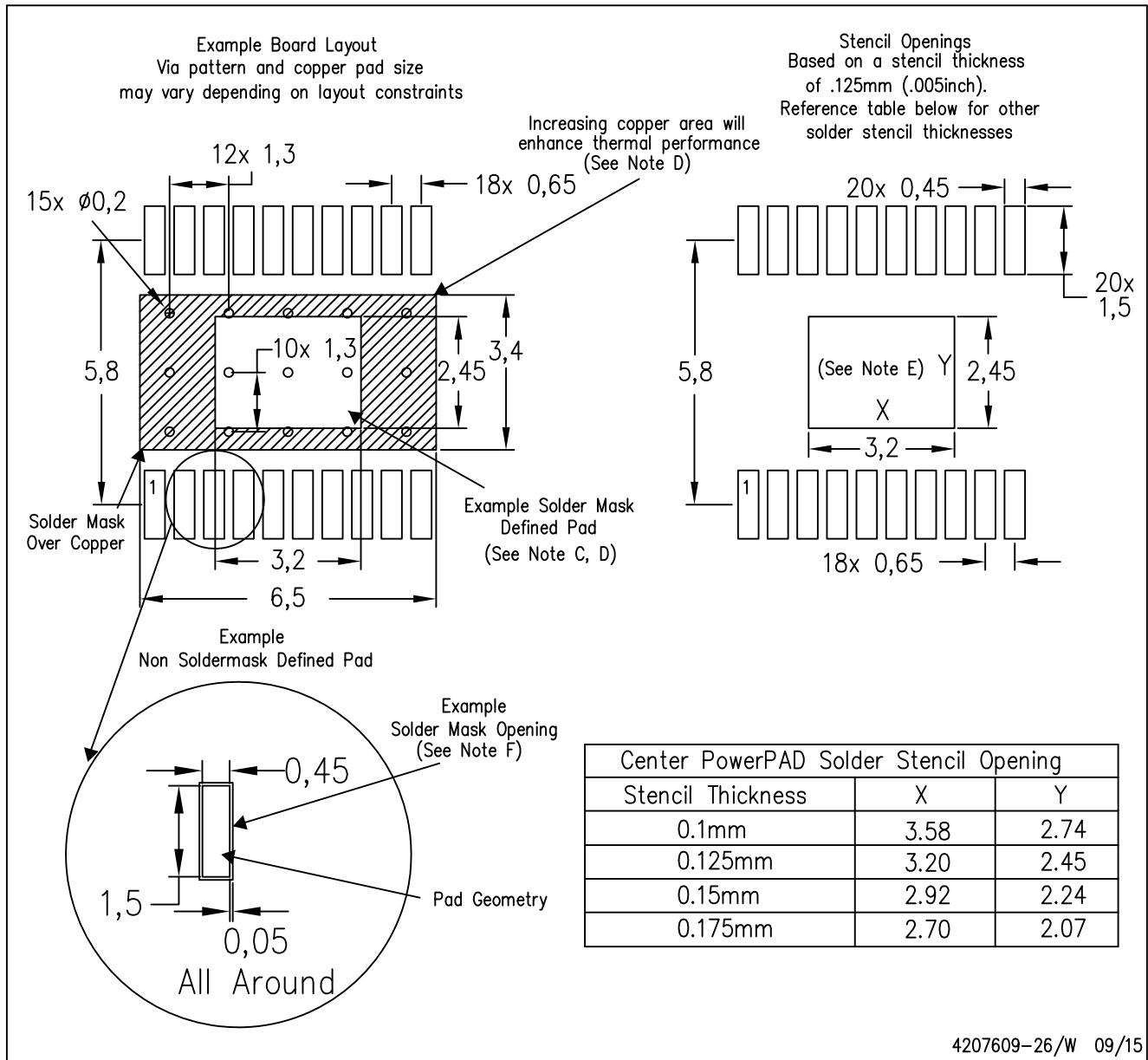

- NOTES:
- All linear dimensions are in millimeters.
 - This drawing is subject to change without notice.
 - Customers should place a note on the circuit board fabrication drawing not to alter the center solder mask defined pad.
 - This package is designed to be soldered to a thermal pad on the board. Refer to Technical Brief, PowerPad Thermally Enhanced Package, Texas Instruments Literature No. SLMA002, SLMA004, and also the Product Data Sheets for specific thermal information, via requirements, and recommended board layout. These documents are available at www.ti.com <<http://www.ti.com>>. Publication IPC-7351 is recommended for alternate designs.
 - Laser cutting apertures with trapezoidal walls and also rounding corners will offer better paste release. Customers should contact their board assembly site for stencil design recommendations. Example stencil design based on a 50% volumetric metal load solder paste. Refer to IPC-7525 for other stencil recommendations.
 - Customers should contact their board fabrication site for solder mask tolerances between and around signal pads.

IMPORTANT NOTICE AND DISCLAIMER

TI PROVIDES TECHNICAL AND RELIABILITY DATA (INCLUDING DATASHEETS), DESIGN RESOURCES (INCLUDING REFERENCE DESIGNS), APPLICATION OR OTHER DESIGN ADVICE, WEB TOOLS, SAFETY INFORMATION, AND OTHER RESOURCES "AS IS" AND WITH ALL FAULTS, AND DISCLAIMS ALL WARRANTIES, EXPRESS AND IMPLIED, INCLUDING WITHOUT LIMITATION ANY IMPLIED WARRANTIES OF MERCHANTABILITY, FITNESS FOR A PARTICULAR PURPOSE OR NON-INFRINGEMENT OF THIRD PARTY INTELLECTUAL PROPERTY RIGHTS.

These resources are intended for skilled developers designing with TI products. You are solely responsible for (1) selecting the appropriate TI products for your application, (2) designing, validating and testing your application, and (3) ensuring your application meets applicable standards, and any other safety, security, or other requirements. These resources are subject to change without notice. TI grants you permission to use these resources only for development of an application that uses the TI products described in the resource. Other reproduction and display of these resources is prohibited. No license is granted to any other TI intellectual property right or to any third party intellectual property right. TI disclaims responsibility for, and you will fully indemnify TI and its representatives against, any claims, damages, costs, losses, and liabilities arising out of your use of these resources.

TI's products are provided subject to TI's Terms of Sale (www.ti.com/legal/termsofsale.html) or other applicable terms available either on ti.com or provided in conjunction with such TI products. TI's provision of these resources does not expand or otherwise alter TI's applicable warranties or warranty disclaimers for TI products.

Mailing Address: Texas Instruments, Post Office Box 655303, Dallas, Texas 75265
Copyright © 2020, Texas Instruments Incorporated