

3950X SERIES  
3.50mm HEADERS

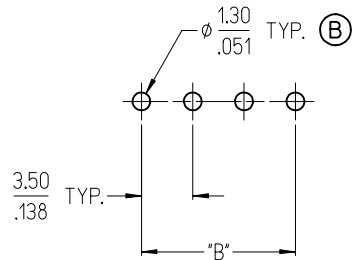

3952X & 3954X SERIES  
5.00mm HEADERS  
5.00mm FIXED

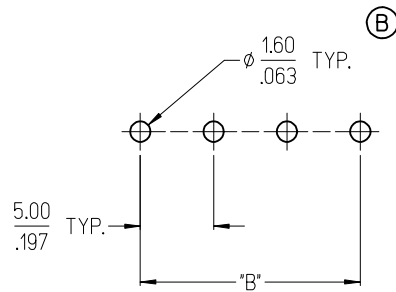

3953X SERIES  
5.08mm HEADERS

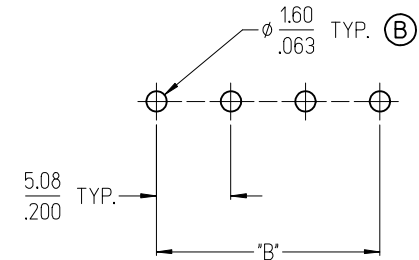

3951X SERIES  
3.81mm HEADERS

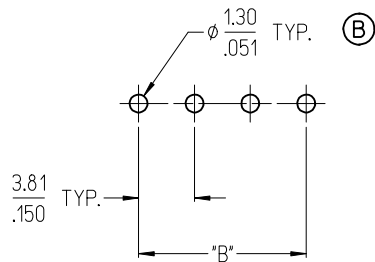

3954X SERIES  
5.00mm FIXED

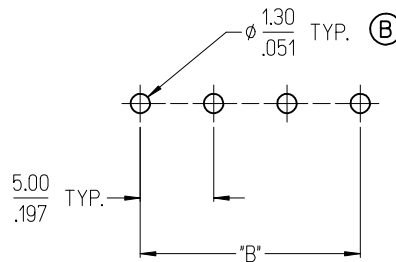

3954X SERIES  
5.08mm FIXED

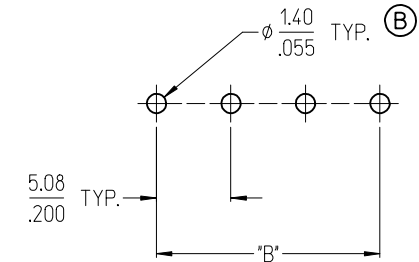

NOTES:

- REFER TO INDIVIDUAL PRODUCT SALES DRAWINGS FOR "B" DIMENSION.
- DOES NOT APPLY TO DUAL LEVEL HEADERS, SERIES 39528 AND 39538.
- TYP. = TYPICAL.

TOLERANCES			
MM	TOL	INCH	TOL
0-6	±0.25	0-.24	±.010
>6-30	±0.40	.24-1.18	±.016
>30-120	±0.50	1.18-4.76	±.020
>120	±0.80	>4.76	±.031

REVISED DOC TOL  
EC NO: IPG2017-0881  
DRAWN: VASUTHKARP 2017/03/23  
CHKD:  
APPR: BRUPERT 2017/04/18  
REV DESCRIPTION

QUALITY SYMBOLS  
▽=0  
▽=0

GENERAL TOLERANCES (UNLESS SPECIFIED)

	mm	INCH
4 PLACES	±---	±---
3 PLACES	±---	±---
2 PLACES	±---	±---
1 PLACE	±---	±---
ANGULAR ±---°		

DRAFT WHERE APPLICABLE  
MUST REMAIN  
WITHIN DIMENSIONS

DIMENSION STYLE  
MM/IN

DRAWN BY	DATE
C. YORK	2006/08/25
CHECKED BY	DATE
J. MACNEIL	2006/08/25
APPROVED BY	DATE
J. MACNEIL	2006/08/25

MATERIAL NO. --

SCALE DESIGN UNITS INCH

THIRD ANGLE PROJECTION

TITLE  
RECOMMENDED PCB LAYOUT FOR ESE TERMINAL BLOCKS

**molex** MOLEX INCORPORATED

DOCUMENT NO. SD-39501-002

SHEET NO. 1 OF 1

THIS DRAWING CONTAINS INFORMATION THAT IS PROPRIETARY TO MOLEX INCORPORATED AND SHOULD NOT BE USED WITHOUT WRITTEN PERMISSION

3950X SERIES  
3.50mm HEADERS

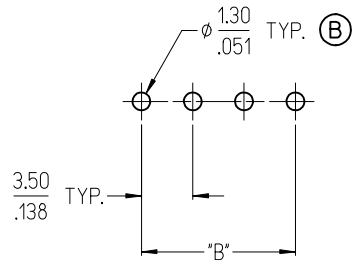

3952X & 3954X SERIES  
5.00mm HEADERS  
5.00mm FIXED

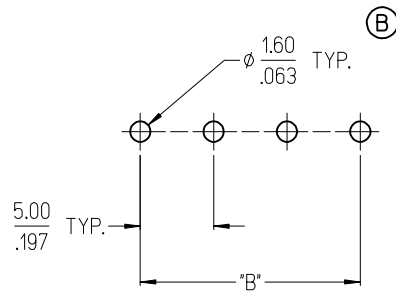

3953X SERIES  
5.08mm HEADERS

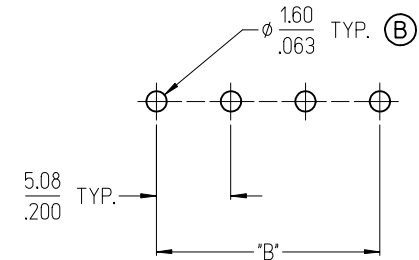

3951X SERIES  
3.81mm HEADERS

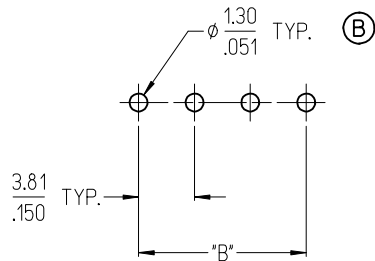

3954X SERIES  
5.00mm FIXED

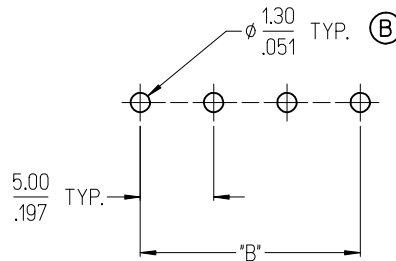

3954X SERIES  
5.08mm FIXED

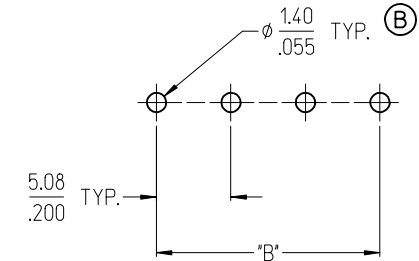

NOTES:

- REFER TO INDIVIDUAL PRODUCT SALES DRAWINGS FOR "B" DIMENSION.
- DOES NOT APPLY TO DUAL LEVEL HEADERS, SERIES 39528 AND 39538.
- TYP. = TYPICAL.

TOLERANCES			
MM	TOL	INCH	TOL
0-6	±0.25	0-.24	±.010
>6-30	±0.40	.24-1.18	±.016
>30-120	±0.50	1.18-4.76	±.020
>120	±0.80	>4.76	±.031

REVISED DOC TOL  
EC NO: IPG2017-0881  
DRAWN: VASUTHKARP 2017/03/23  
CHKD:  
APPR: BRUPERT 2017/04/18  
REV DESCRIPTION

QUALITY SYMBOLS  
▽=0  
▽=0

GENERAL TOLERANCES (UNLESS SPECIFIED)

	mm	INCH
4 PLACES	±---	±---
3 PLACES	±---	±---
2 PLACES	±---	±---
1 PLACE	±---	±---
ANGULAR ±---°		

DRAFT WHERE APPLICABLE  
MUST REMAIN  
WITHIN DIMENSIONS

DIMENSION STYLE  
MM/IN

DRAWN BY	DATE
C. YORK	2006/08/25
CHECKED BY	DATE
J. MACNEIL	2006/08/25
APPROVED BY	DATE
J. MACNEIL	2006/08/25

MATERIAL NO. --

SCALE DESIGN UNITS INCH

THIRD ANGLE PROJECTION

RECOMMENDED PCB LAYOUT FOR ESE TERMINAL BLOCKS

**molex** MOLEX INCORPORATED

DOCUMENT NO. SD-39501-002

SHEET NO. 1 OF 1

THIS DRAWING CONTAINS INFORMATION THAT IS PROPRIETARY TO MOLEX INCORPORATED AND SHOULD NOT BE USED WITHOUT WRITTEN PERMISSION

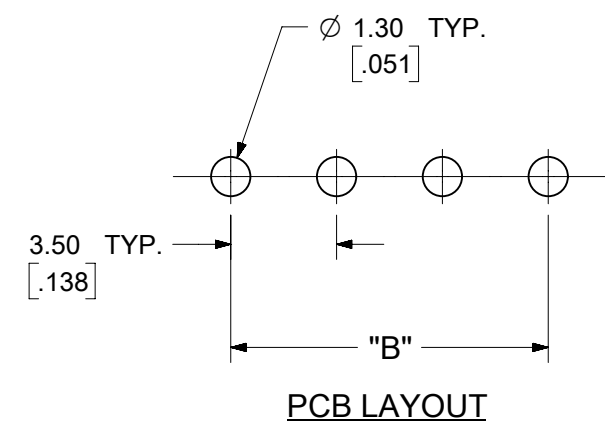
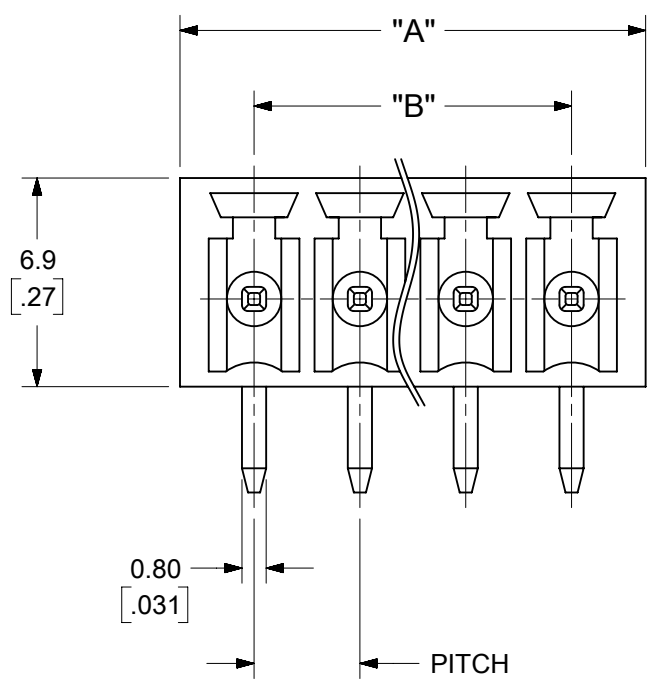
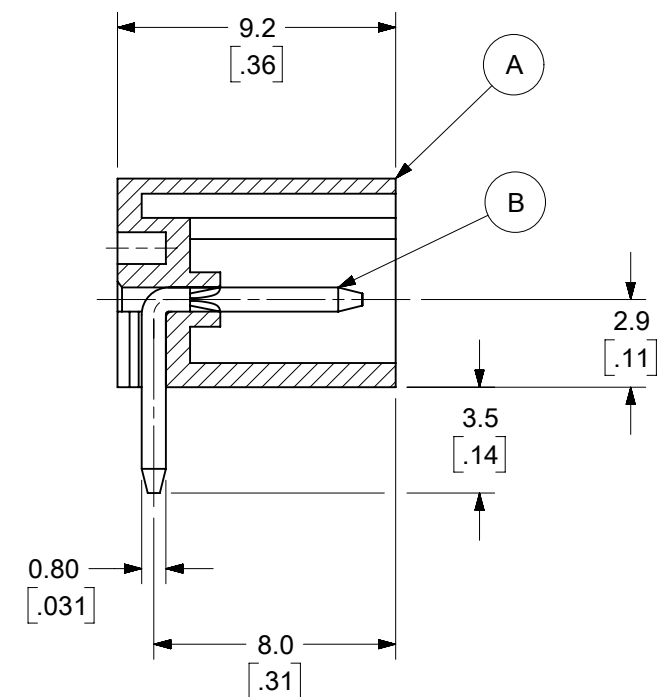
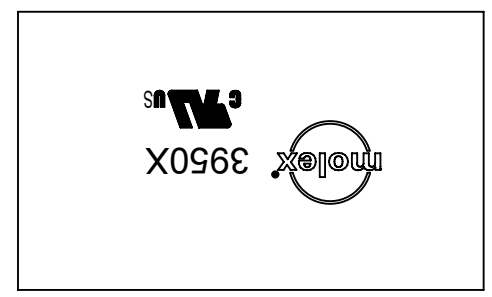
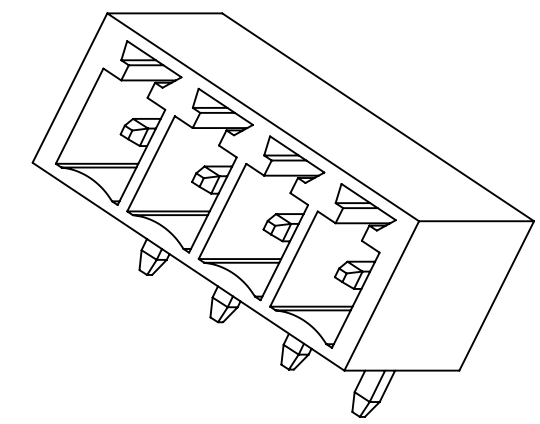









**SPECIFICATIONS:**

1. MATERIAL:
  - A. BODY: PA66
  - B. TERMINAL: BRASS
2. WIRE RANGE: N/A
3. ELECTRICAL RATING: 300V, 8A.
4. MAX TORQUE: N/A.
5. WIRE STRIP LENGTH: N/A.
6. OPERATING TEMPERATURE: -40°C to +105°C.
7.  $A = (N \times P) + 1.39\text{MM}$
8.  $B = (N - 1) \times P$
9.  $P$  (PITCH) = 3.5MM (.138").
10.  $N$  = NUMBER OF POSITIONS AVAILABLE 2 THROUGH 20.

TOLERANCES			
MM	TOL	INCH	TOL
0-6	±0.25	0-.24	±.010
>6-30	±0.40	.24-1.18	±.016
>30-120	±0.50	1.18-4.76	±.020
>120	±0.80	>4.76	±.031

SYMBOLS	THIS DRAWING CONTAINS INFORMATION THAT IS PROPRIETARY TO MOLEX ELECTRONIC TECHNOLOGIES, LLC AND SHOULD NOT BE USED WITHOUT WRITTEN PERMISSION						
	DIMENSION UNITS	SCALE					CURRENT REV DESC: MIGRATION TO ECTR/NX
▽ = 0	MM/INCH	4:1		EC NO: 619929			
▽ = 0	GENERAL TOLERANCES (UNLESS SPECIFIED)			DRWN: ABENJAMINLW 2019/06/11			
▽ = 0				CHK'D: DACHAMMER 2019/07/01			
▽ = 0				APPR: JFMURPHY 2019/07/08			
▽ = 0				INITIAL REVISION:			
▽ = 0				DRWN: LROTHAUS 2006/01/09			
▽ = 0				APPR: JPAWLICK 2006/01/10			
▽ = 0				DOCUMENT NUMBER	DOC TYPE	DOC PART	REVISION
▽ = 0				SD-39502-001	PSD	001	B2
▽ = 0				MATERIAL NUMBER	CUSTOMER	SHEET NUMBER	
▽ = 0				SEE SHEET-2	GENERAL MARKET	1 OF 2	

		MATERIAL NUMBERS												DIMENSIONAL INFORMATION			
		BLACK						GREEN									
		100% TIN			30 u" GOLD			100% TIN			30 u" GOLD						
DESCRIPTION	CIRCUIT SIZE	PRINTING OPTIONS			PRINTING OPTIONS			PRINTING OPTIONS			PRINTING OPTIONS			DIM. "A"		DIM. "B"	
		None	10AV	11AV	None	10AV	11AV	None	10AV	11AV	None	10AV	11AV	mm	inch	mm	inch
3.5MM, EURO HEADER, RIGHT ANGLE	2	395021002	395021102	395021202	395021502	395021602	395021702	395026002	395026102	395026202	395026502	395026602	395026702	8.40	.331	3.50	.138
3.5MM, EURO HEADER, RIGHT ANGLE	3	395021003	395021103	395021203	395021503	395021603	395021703	395026003	395026103	395026203	395026503	395026603	395026703	11.90	.469	7.00	.276
3.5MM, EURO HEADER, RIGHT ANGLE	4	395021004	395021104	395021204	395021504	395021604	395021704	395026004	395026104	395026204	395026504	395026604	395026704	15.40	.606	10.50	.413
3.5MM, EURO HEADER, RIGHT ANGLE	5	395021005	395021105	395021205	395021505	395021605	395021705	395026005	395026105	395026205	395026505	395026605	395026705	18.90	.744	14.00	.551
3.5MM, EURO HEADER, RIGHT ANGLE	6	395021006	395021106	395021206	395021506	395021606	395021706	395026006	395026106	395026206	395026506	395026606	395026706	22.40	.882	17.50	.689
3.5MM, EURO HEADER, RIGHT ANGLE	7	395021007	395021107	395021207	395021507	395021607	395021707	395026007	395026107	395026207	395026507	395026607	395026707	25.90	1.020	21.00	.827
3.5MM, EURO HEADER, RIGHT ANGLE	8	395021008	395021108	395021208	395021508	395021608	395021708	395026008	395026108	395026208	395026508	395026608	395026708	29.40	1.157	24.50	.965
3.5MM, EURO HEADER, RIGHT ANGLE	9	395021009	395021109	395021209	395021509	395021609	395021709	395026009	395026109	395026209	395026509	395026609	395026709	32.90	1.295	28.00	1.102
3.5MM, EURO HEADER, RIGHT ANGLE	10	395021010	395021110	395021210	395021510	395021610	395021710	395026010	395026110	395026210	395026510	395026610	395026710	36.40	1.433	31.50	1.240
3.5MM, EURO HEADER, RIGHT ANGLE	11	395021011	395021111	395021211	395021511	395021611	395021711	395026011	395026111	395026211	395026511	395026611	395026711	39.90	1.571	35.00	1.378
3.5MM, EURO HEADER, RIGHT ANGLE	12	395021012	395021112	395021212	395021512	395021612	395021712	395026012	395026112	395026212	395026512	395026612	395026712	43.40	1.709	38.50	1.516
3.5MM, EURO HEADER, RIGHT ANGLE	13	395021013	395021113	395021213	395021513	395021613	395021713	395026013	395026113	395026213	395026513	395026613	395026713	46.90	1.846	42.00	1.654
3.5MM, EURO HEADER, RIGHT ANGLE	14	395021014	395021114	395021214	395021514	395021614	395021714	395026014	395026114	395026214	395026514	395026614	395026714	50.40	1.984	45.50	1.791
3.5MM, EURO HEADER, RIGHT ANGLE	15	395021015	395021115	395021215	395021515	395021615	395021715	395026015	395026115	395026215	395026515	395026615	395026715	53.90	2.122	49.00	1.929
3.5MM, EURO HEADER, RIGHT ANGLE	16	395021016	395021116	395021216	395021516	395021616	395021716	395026016	395026116	395026216	395026516	395026616	395026716	57.40	2.260	52.50	2.067
3.5MM, EURO HEADER, RIGHT ANGLE	17	395021017	395021117	395021217	395021517	395021617	395021717	395026017	395026117	395026217	395026517	395026617	395026717	60.90	2.398	56.00	2.205
3.5MM, EURO HEADER, RIGHT ANGLE	18	395021018	395021118	395021218	395021518	395021618	395021718	395026018	395026118	395026218	395026518	395026618	395026718	64.40	2.535	59.50	2.343
3.5MM, EURO HEADER, RIGHT ANGLE	19	395021019	395021119	395021219	395021519	395021619	395021719	395026019	395026119	395026219	395026519	395026619	395026719	67.90	2.673	63.00	2.480
3.5MM, EURO HEADER, RIGHT ANGLE	20	395021020	395021120	395021220	395021520	395021620	395021720	395026020	395026120	395026220	395026520	395026620	395026720	71.40	2.811	66.50	2.618

<b>TOLERANCES</b>				<b>SYMBOLS</b>  = 0  = 0  = 0  = 0  = 0  = 0  = 0  = 0	<table border="1"> <thead> <tr> <th>MM</th> <th>TOL</th> <th>INCH</th> <th>TOL</th> </tr> </thead> <tbody> <tr> <td>0-6</td> <td>±0.25</td> <td>0-.24</td> <td>±.010</td> </tr> <tr> <td>&gt;6-30</td> <td>±0.40</td> <td>.24-1.18</td> <td>±.016</td> </tr> <tr> <td>&gt;30-120</td> <td>±0.50</td> <td>1.18-4.76</td> <td>±.020</td> </tr> <tr> <td>&gt;120</td> <td>±0.80</td> <td>&gt;4.76</td> <td>±.031</td> </tr> </tbody> </table>	MM	TOL	INCH	TOL	0-6	±0.25	0-.24	±.010	>6-30	±0.40	.24-1.18	±.016	>30-120	±0.50	1.18-4.76	±.020	>120	±0.80	>4.76	±.031	<table border="1"> <tr> <td>           DIMENSION UNITS  <b>MM/INCH</b> </td> <td>           SCALE  <b>2:1</b> </td> </tr> <tr> <td colspan="2">           GENERAL TOLERANCES (UNLESS SPECIFIED)         </td> </tr> <tr> <td>           4 PLACES ±         </td> <td>           ±         </td> </tr> <tr> <td>           3 PLACES ±         </td> <td>           ± SEE CHART         </td> </tr> <tr> <td>           2 PLACES ±         </td> <td>           ± SEE CHART         </td> </tr> <tr> <td>           1 PLACE ±         </td> <td>           ± SEE CHART         </td> </tr> <tr> <td>           0 PLACES ±         </td> <td>           ±         </td> </tr> <tr> <td colspan="2">           ANGULAR TOL ± °         </td> </tr> <tr> <td colspan="2">           DRAFT WHERE APPLICABLE MUST REMAIN WITHIN DIMENSIONS         </td> </tr> </table>	DIMENSION UNITS <b>MM/INCH</b>	SCALE <b>2:1</b>	GENERAL TOLERANCES (UNLESS SPECIFIED)		4 PLACES ±	±	3 PLACES ±	± SEE CHART	2 PLACES ±	± SEE CHART	1 PLACE ±	± SEE CHART	0 PLACES ±	±	ANGULAR TOL ± °		DRAFT WHERE APPLICABLE MUST REMAIN WITHIN DIMENSIONS		THIS DRAWING CONTAINS INFORMATION THAT IS PROPRIETARY TO MOLEX ELECTRONIC TECHNOLOGIES, LLC AND SHOULD NOT BE USED WITHOUT WRITTEN PERMISSION  CURRENT REV DESC: MIGRATION TO ECTR/NX  EC NO: 619929 DRWN: ABENJAMINLW 2019/06/11 CHK'D: DACHAMMER 2019/07/01 APPR: JFMURPHY 2019/07/08  INITIAL REVISION: DRWN: LROTHAUS 2006/01/09 APPR: JPAWLICK 2006/01/10	<table border="1"> <tr> <td colspan="4" style="text-align: center;"><b>molex</b></td> </tr> <tr> <td colspan="4" style="text-align: center;">3.5MM, EURO HEADER RIGHT ANGLE, CLOSED END</td> </tr> <tr> <td colspan="4" style="text-align: center;">PRODUCT CUSTOMER DRAWING</td> </tr> <tr> <td>DOCUMENT NUMBER</td> <td>DOC TYPE</td> <td>DOC PART</td> <td>REVISION</td> </tr> <tr> <td style="text-align: center;"><b>SD-39502-001</b></td> <td style="text-align: center;">PSD</td> <td style="text-align: center;">001</td> <td style="text-align: center;"><b>B2</b></td> </tr> <tr> <td>MATERIAL NUMBER</td> <td colspan="2">CUSTOMER</td> <td>SHEET NUMBER</td> </tr> <tr> <td style="text-align: center;">SEE TABLE</td> <td colspan="2" style="text-align: center;">GENERAL MARKET</td> <td style="text-align: center;">2 OF 2</td> </tr> </table>	<b>molex</b>				3.5MM, EURO HEADER RIGHT ANGLE, CLOSED END				PRODUCT CUSTOMER DRAWING				DOCUMENT NUMBER	DOC TYPE	DOC PART	REVISION	<b>SD-39502-001</b>	PSD	001	<b>B2</b>	MATERIAL NUMBER	CUSTOMER		SHEET NUMBER	SEE TABLE	GENERAL MARKET		2 OF 2
MM	TOL	INCH	TOL																																																																							
0-6	±0.25	0-.24	±.010																																																																							
>6-30	±0.40	.24-1.18	±.016																																																																							
>30-120	±0.50	1.18-4.76	±.020																																																																							
>120	±0.80	>4.76	±.031																																																																							
DIMENSION UNITS <b>MM/INCH</b>	SCALE <b>2:1</b>																																																																									
GENERAL TOLERANCES (UNLESS SPECIFIED)																																																																										
4 PLACES ±	±																																																																									
3 PLACES ±	± SEE CHART																																																																									
2 PLACES ±	± SEE CHART																																																																									
1 PLACE ±	± SEE CHART																																																																									
0 PLACES ±	±																																																																									
ANGULAR TOL ± °																																																																										
DRAFT WHERE APPLICABLE MUST REMAIN WITHIN DIMENSIONS																																																																										
<b>molex</b>																																																																										
3.5MM, EURO HEADER RIGHT ANGLE, CLOSED END																																																																										
PRODUCT CUSTOMER DRAWING																																																																										
DOCUMENT NUMBER	DOC TYPE	DOC PART	REVISION																																																																							
<b>SD-39502-001</b>	PSD	001	<b>B2</b>																																																																							
MATERIAL NUMBER	CUSTOMER		SHEET NUMBER																																																																							
SEE TABLE	GENERAL MARKET		2 OF 2																																																																							
DIMENSION UNITS <b>MM/INCH</b>	SCALE <b>2:1</b>																																																																									
GENERAL TOLERANCES (UNLESS SPECIFIED)																																																																										
4 PLACES ±	±																																																																									
3 PLACES ±	± SEE CHART																																																																									
2 PLACES ±	± SEE CHART																																																																									
1 PLACE ±	± SEE CHART																																																																									
0 PLACES ±	±																																																																									
ANGULAR TOL ± °																																																																										
DRAFT WHERE APPLICABLE MUST REMAIN WITHIN DIMENSIONS																																																																										