

MAX44000PMB1 Peripheral Module

General Description

The MAX44000PMB1 peripheral module provides the necessary hardware to interface the MAX44000 ambient and infrared proximity sensor to any system that utilizes Pmod™-compatible expansion ports configurable for I²C communication. The IC combines a wide-dynamic range ambient light sensor with an integrated infrared (IR) proximity sensor. The on-chip ambient light sensor has the ability to make wide dynamic range 0.03 lux to 65,535 lux measurements. An on-chip IR proximity detector is matched with an integrated IR LED driver. All readings are available on an I²C communication bus.

Refer to the MAX44000 IC data sheet for detailed information regarding operation of the IC.

Features

- ◆ Ambient Light Sensor
- ◆ Close Range Proximity Detector
- ◆ Integrated Single-Pulse IR LED Driver
- ◆ 6-Pin Pmod-Compatible Connector (I²C)
- ◆ Example Software Written in C for Portability
- ◆ Secondary Header Allows Daisy-Chaining of Additional Modules on the I²C Bus
- ◆ RoHS Compliant
- ◆ Proven PCB Layout
- ◆ Fully Assembled and Tested

Ordering Information appears at end of data sheet.

MAX44000PMB1 Peripheral Module

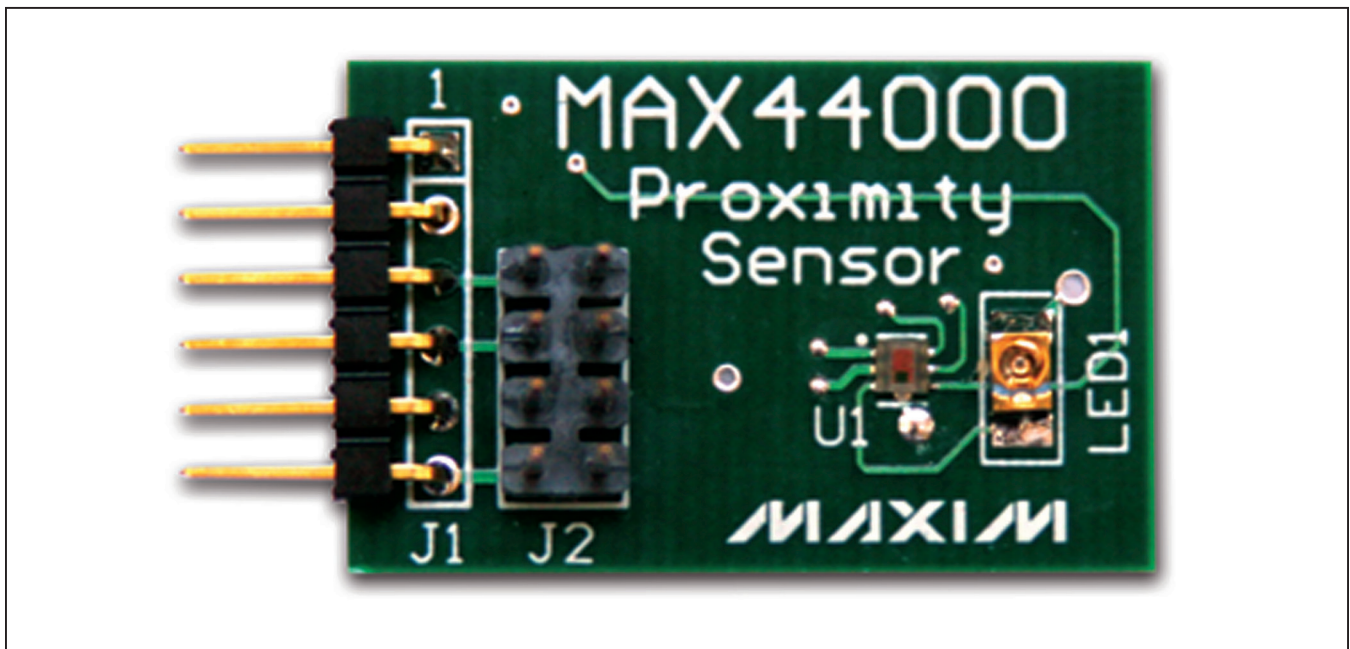

Pmod is a trademark of Digilent Inc.

MAX44000PMB1 Peripheral Module

Component List

DESIGNATION	QTY	DESCRIPTION
C1	1	2.2 μ F \pm 10%, 10V X5R ceramic capacitor (0603) TDK C1608X5R1A225K/0.80
C2	1	0.1 μ F \pm 10%, 16V X7R ceramic capacitor (0603) Murata GRM188R71C104KA01D
J1	1	6-pin right-angle male header
J2	1	8-pin (2 x 4) straight male header
LED1	1	70mA, 1.6V, 860nm IR LED (MIDLED) OSRAM SFH4651

DESIGNATION	QTY	DESCRIPTION
R1, R2, R3	3	150 Ω \pm 5% resistors (0603)
R4	1	33 Ω \pm 5% resistor (0603)
R5, R6, R7	3	4.7k Ω \pm 5% resistors (0603)
U1	1	Ambient and IR proximity sensor (6 OTDFN-EP*) Maxim MAX44000GDT+
—	1	PCB: EPCB44000PM1

*EP = Exposed pad.

Component Suppliers

SUPPLIER	PHONE	WEBSITE
Murata Electronics North America, Inc.	770-436-1300	www.murata-northamerica.com
OSRAM Opto Semiconductors	888-446-7726	www.osram-os.com
TDK Corp.	847-803-6100	www.component.tdk.com

Note: Indicate that you are using the MAX44000PMB1 when contacting these component suppliers.

Detailed Description

I²C Interface

The MAX44000PMB1 peripheral module can interface to the host in one of two ways. It can plug directly into a Pmod-compatible port (configured for I²C) through connector J1, or in this case, other I²C boards can attach to the same I²C bus through connector J2.

I²C Interface (Daisy-Chaining Modules)

Alternatively, the peripheral module can connect to other I²C-based Pmod modules using a 4-conductor ribbon cable connecting to the J2 connector. In this situation, pins 1-4 and 5-8 on J2 provide two connections to the I²C bus, allowing the module to be inserted into an I²C bus daisy-chain.

Connector J1 provides connection of the module to the Pmod host. The pin assignments and functions adhere to the Pmod standard recommended by Digilent. See Table 1.

The J2 connector allows the module to be connected through a daisy-chain from another I²C module and/or provide I²C and power connections to other I²C modules on the same bus. See Table 2.

Table 1. Connector J1 (I²C Communication)

PIN	SIGNAL	DESCRIPTION
1	N.C.	Not connected
2	$\overline{\text{INT}}$	Interrupt. Open-drain output from module that is pulled low when an interrupt condition occurs (e.g., when ambient lux readings exceed threshold limits for a period greater than that set by the Time register).
3	SCL	I ² C serial clock
4	SDA	I ² C serial data
5	GND	Ground
6	VCC	Power supply

Table 2. Connector J2 (I²C Expansion)

PIN	SIGNAL	DESCRIPTION
1	SCL	I ² C serial clock
2	SDA	I ² C serial data
3	GND	Ground
4	VCC	Power supply
5	SCL	I ² C serial clock (same as pin 1 above)
6	SDA	I ² C serial data (same as pin 2 above)
7	GND	Ground
8	VCC	Power supply

MAX4400PMB1 Peripheral Module

Software and FPGA Code

Example software and drivers are available that execute directly without modification on several FPGA development boards that support an integrated or synthesized microprocessor. These boards include the Digilent Nexys 3, Avnet LX9, and Avnet ZEDBoard, although other platforms can be added over time. Maxim provides complete Xilinx ISE projects containing HDL, Platform Studio, and SDK projects. In addition, a synthesized bit stream, ready for FPGA download, is provided for the demonstration application.

The software project (for the SDK) contains several source files intended to accelerate customer evaluation and design. These include a base application (maximModules.c) that demonstrates module functionality and uses an API interface (maximDeviceSpecificUtilities.c) to set and access Maxim device functions within a specific module.

The source code is written in standard ANSI C format, and all API documentation including theory/operation, register description, and function prototypes are documented in the API interface file (maximDeviceSpecificUtilities.h & .c).

The complete software kit is available for download at www.maxim-ic.com. Quick start instructions are also available as a separate document.

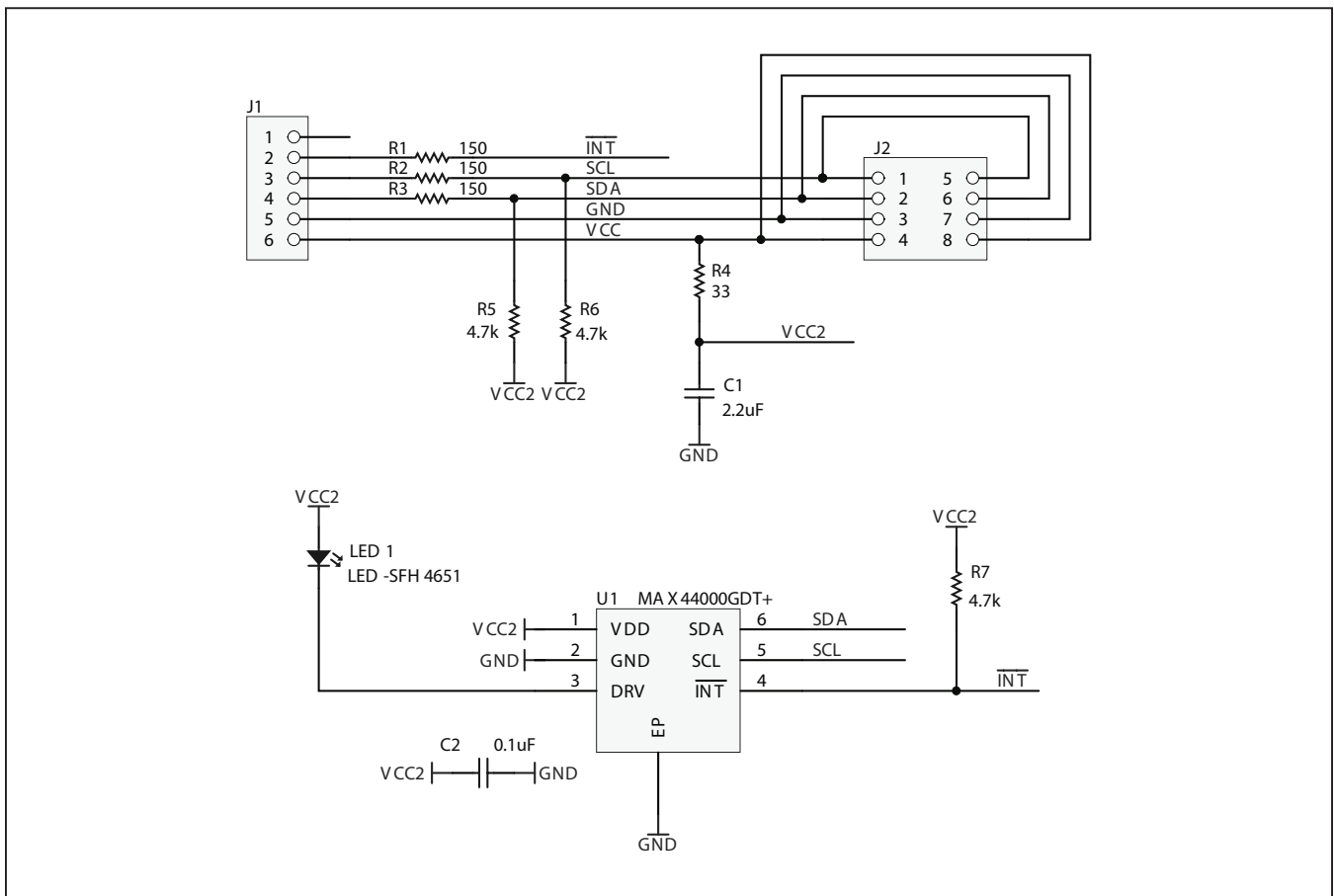

Figure 1. MAX4400PMB1 Peripheral Module Schematic

MAX44000PMB1 Peripheral Module

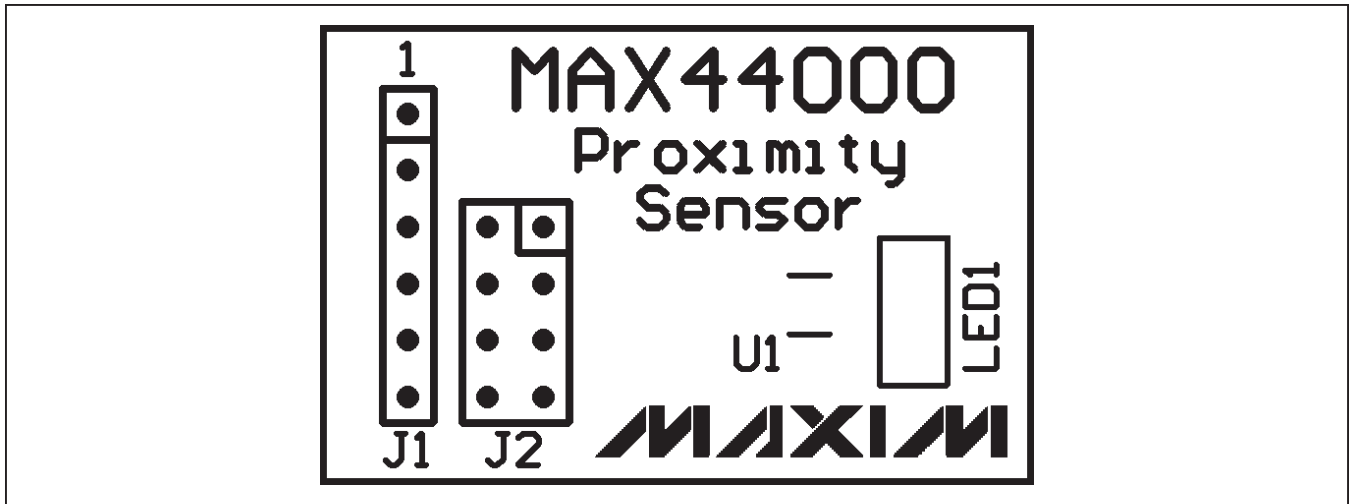

Figure 2. MAX44000PMB11 Peripheral Module Component Placement Guide—Component Side

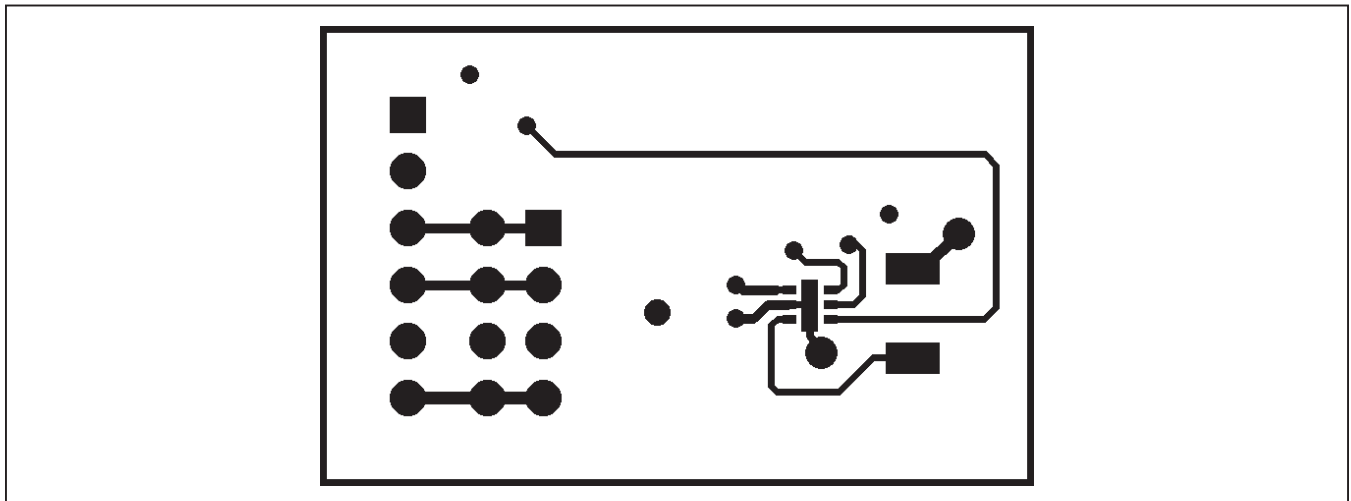

Figure 3. MAX44000PMB11 Peripheral Module PCB Layout—Component Side

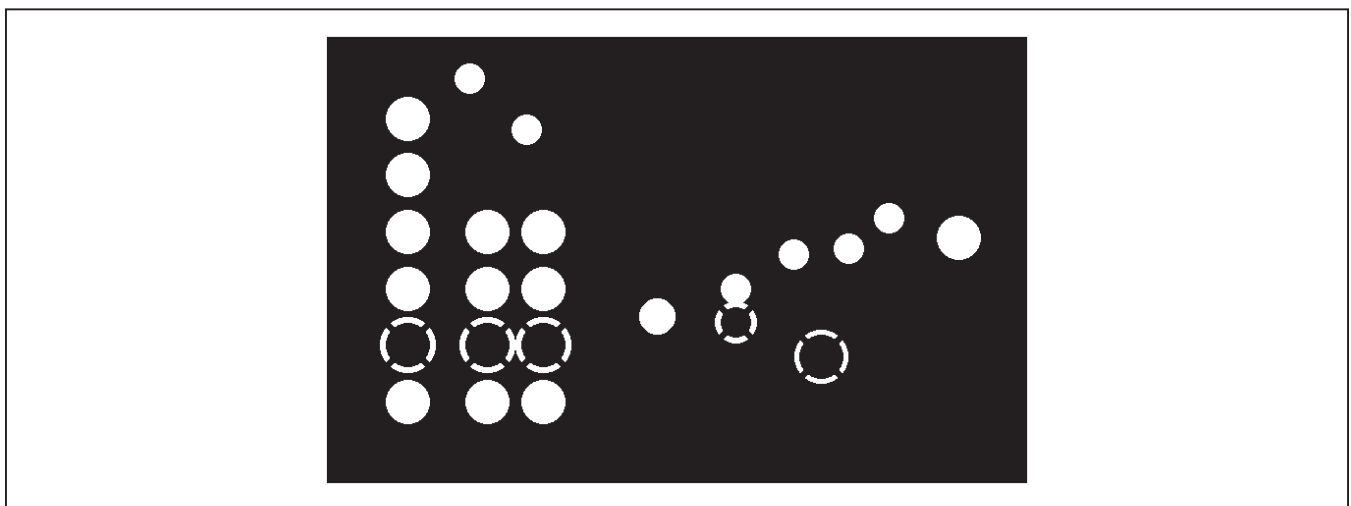

Figure 4. MAX44000PMB11 Peripheral Module PCB Layout—Inner Layer 1 (Ground)

MAX44000PMB1 Peripheral Module

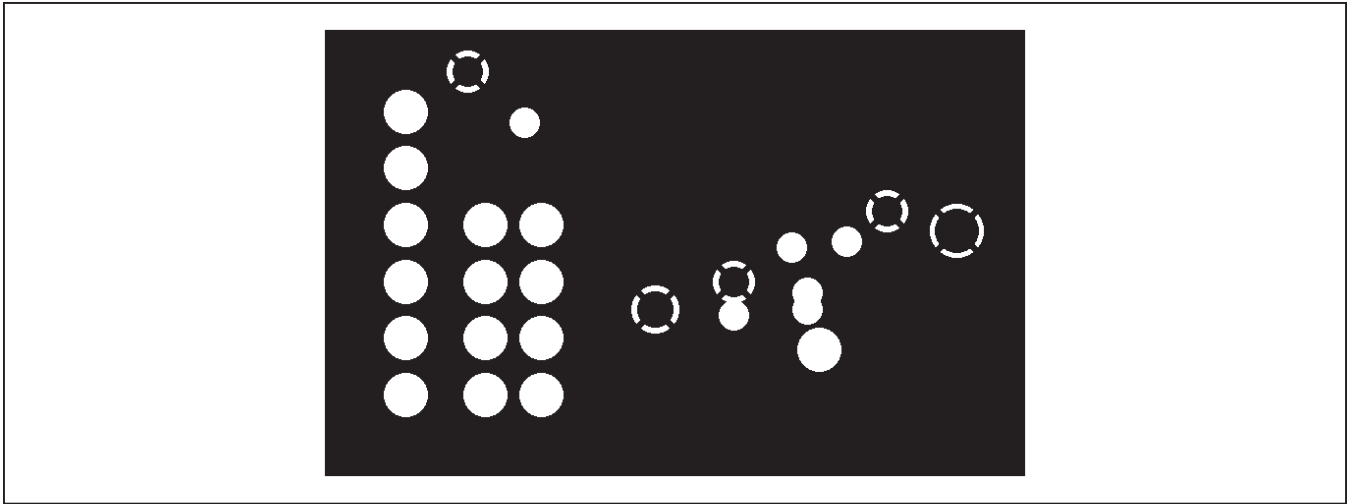

Figure 5. MAX44000PMB11 Peripheral Module PCB Layout—Inner Layer 2 (Power)

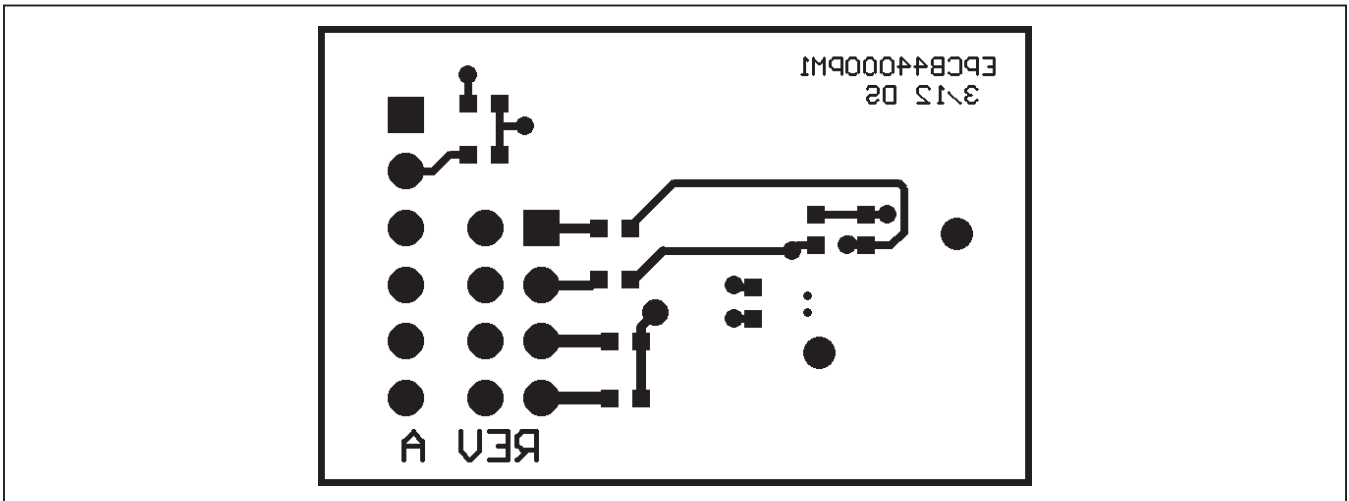

Figure 6. MAX44000PMB11 Peripheral Module PCB Layout—Solder Side

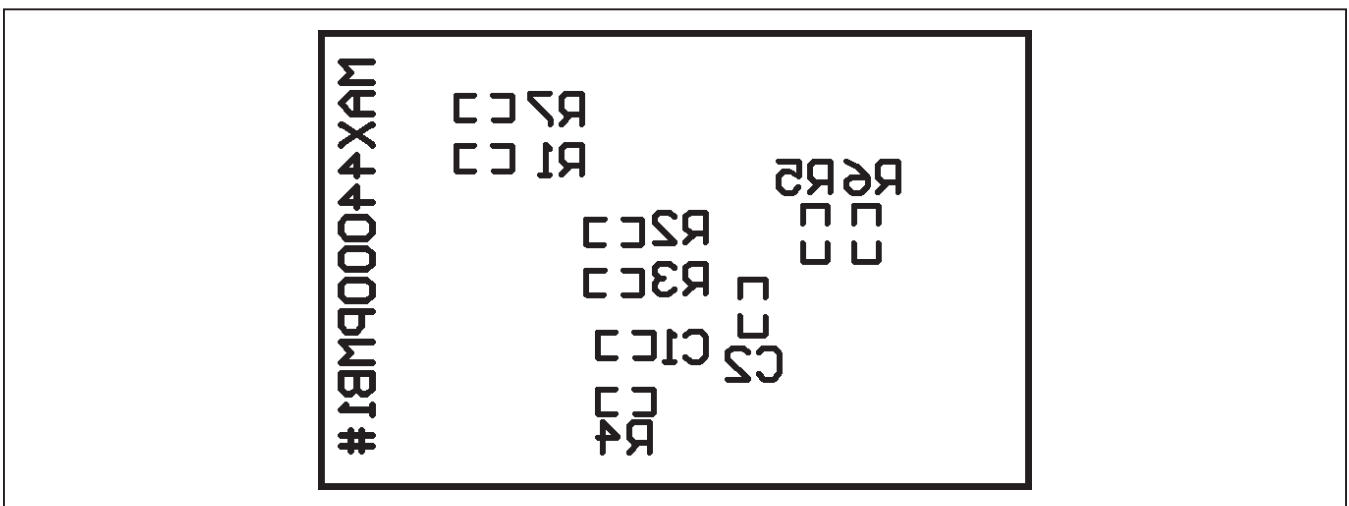

Figure 7. MAX44000PMB11 Peripheral Module Component Placement Guide—Solder Side

MAX44000PMB1 Peripheral Module

Ordering Information

PART	TYPE
MAX44000PMB1#	Peripheral Module

#Denotes RoHS compliant.

MAX44000PMB1 Peripheral Module

Revision History

REVISION NUMBER	REVISION DATE	DESCRIPTION	PAGES CHANGED
0	5/12	Initial release	—

Maxim cannot assume responsibility for use of any circuitry other than circuitry entirely embodied in a Maxim product. No circuit patent licenses are implied. Maxim reserves the right to change the circuitry and specifications without notice at any time.

Maxim Integrated Products, 120 San Gabriel Drive, Sunnyvale, CA 94086 408-737-7600 _____ 7

Mouser Electronics

Authorized Distributor

Click to View Pricing, Inventory, Delivery & Lifecycle Information:

[Maxim Integrated:](#)

[MAX44000PMB1#](#)