



## **iCE40 UltraLite™ Breakout Board User Guide**

---

EB96 Version 1.1, March 2017

## Introduction

Thank you for choosing the Lattice iCE40 UltraLite™ Breakout Board.

This guide describes how to begin using the iCE40 UltraLite Breakout Board, an easy-to-use platform for demonstrating the high-current LED drive capabilities of the iCE40 UltraLite FPGA. Along with the evaluation board and accessories, this kit includes the pre-loaded LED Driver Demo that demonstrates driving the RGB LEDs with a PWM circuit. In addition, most of the device's I/O balls are accessible via one of the several header locations on the board, facilitating rapid prototyping of user functions.

The contents of this user's guide include demo operation, top-level functional descriptions of the various portions of the evaluation board, descriptions of the on-board connectors, jumpers, a complete set of schematics and the bill of material for the iCE40 UltraLite Breakout Board.

*Note: Static electricity can severely shorten the lifespan of electronic components. Be careful when handling the iCE40 UltraLite Breakout Board as to not damage it from ESD.*

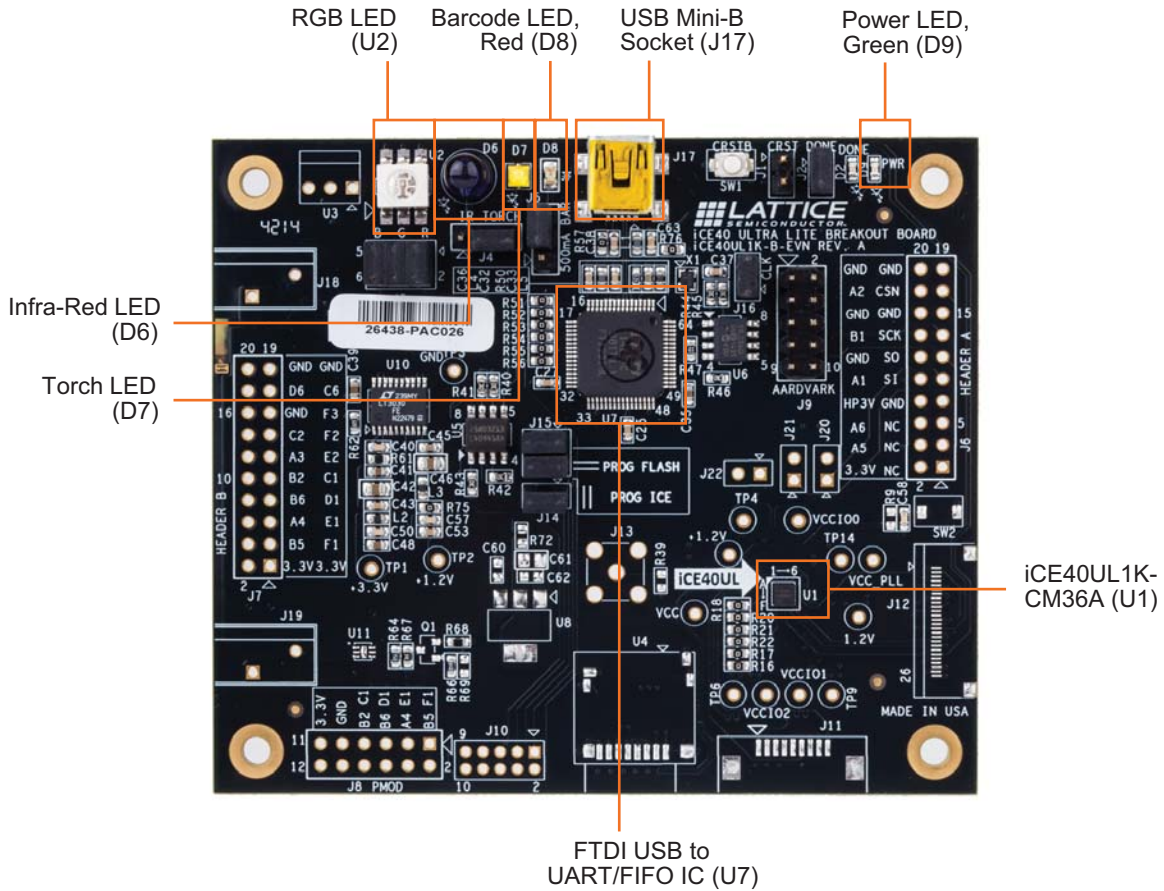
## Features

The iCE40 UltraLite Breakout Board includes:

- **iCE40 UltraLite Breakout Board** – The iCE40 UltraLite Breakout Board features the following on-board components and circuits:
  - iCE40 UltraLite (iCE40UL1K-CM36A) device in a 36-ball WLCSP package.
  - Example of a board using this 0.35-pitch WLCSP package.
  - High-current LED output
  - Infrared transmit
  - iCE40 UltraLite Current Measurements
  - Standard USB cable for device programming
  - RoHS-compliant packaging and process
- **Pre-loaded Demo** – The kit includes a pre-loaded demo to control the onboard RGB LED in conjunction with a software run GUI.
- **USB Connector Cable** – A mini B USB port provides power, a programming interface and communication for the software RGB LED GUI to the iCE40 UltraLite SPI port.

Figure 1 shows the top side of the iCE40 UltraLite Breakout Board indicating the specific features that are designed on the board.

**Figure 1. iCE40 UltraLite Breakout Board (Top Side)**



## iCE40 UltraLite Device

The board features an iCE40UL1K FPGA with a 1.2 V core supply. The device is packaged in a 36-ball WLCSP. For a complete description of this device, see DS1050, [iCE40 UltraLite Family Data Sheet](#).

## Software Requirements

You should install the following software before you begin developing designs for the board:

- iCEcube2 2014.04 (or higher)
- Diamond Programmer 3.3 (or higher)

These software are available at the Lattice website [Design Software & IP](#) page. Make sure you log in to [www.latticesemi.com](http://www.latticesemi.com), otherwise these software downloads will not be visible. It is also recommended to download the RGB LED software GUI which interfaces with the iCE40 UltraLite Breakout Board. This GUI allows you to control the RGB LED for color, brightness, blinking and breathing. Download the PC or MAC version of the GUI at [www.latticesemi.com](http://www.latticesemi.com).

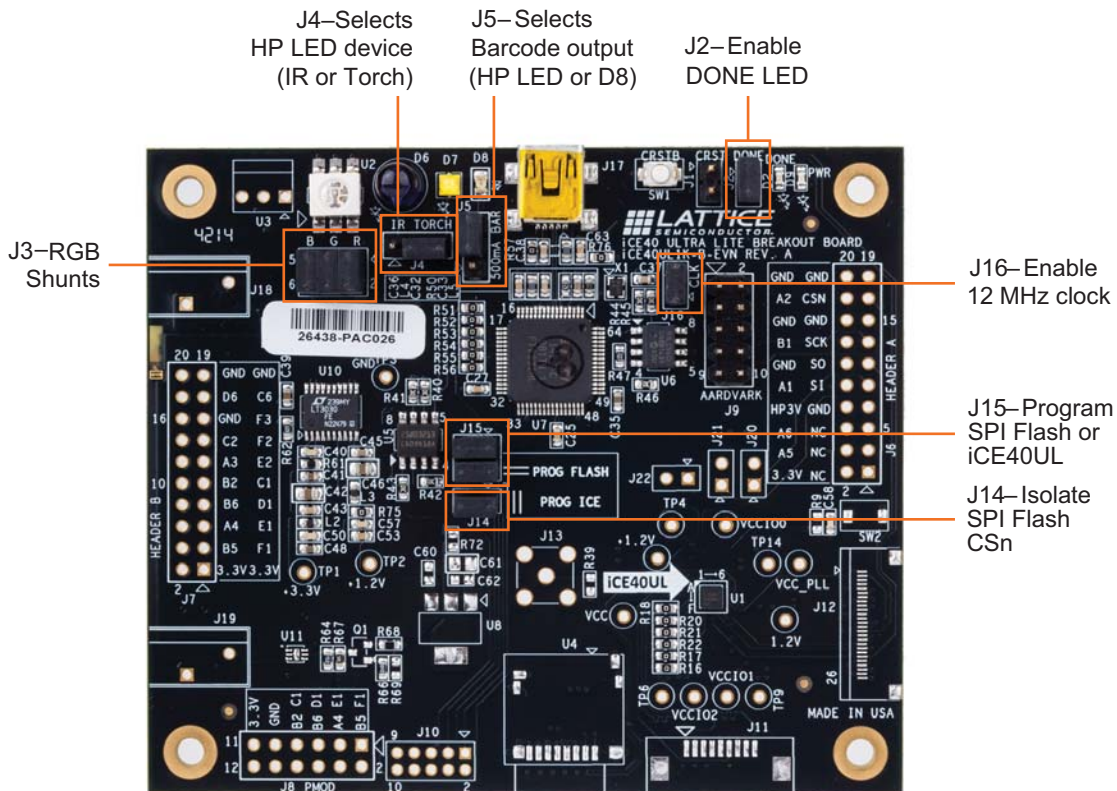
## Demonstration Design Jumpers

Lattice provides the RGB LED Driver Demo design programmed in the board. The RGB LED Driver Demo used in conjunction with the software GUI illustrates the use of a PWM driver controlling the LEDs on the board. Below is a description of the control jumpers for each LED.

- The RGB LED (U2) will transition colors
  - J3 can be used to probe RGB LED (Default shunted). If you remove J3, the RGB LED will not light up.
- The IR LED (D6) is controlled when a jumper is placed across J4 pins 1-2
- The HP Torch LED (D7) is controlled when a jumper is placed across J4 pins 2-3
- The BARCODE LED (D8) is under FPGA control when a jumper is placed across J5 pins 2-3
  - The IRLED FPGA output is 400 mA. This can be combined with 100 mA BARCODE FPGA output for a total of 500 mA of drive current. This is performed when a jumper is placed across J5 pins 1-2.
  - Note: This capability is not supported in the Demonstration Design*

Figure 2 shows the default jumper locations.

**Figure 2. Default Jumper Locations**



## Clock Sources

The board has a single 12 MHz clock source. The 12 MHz clock drives both the FTDI USB interface device, and the iCE40UL1K device. The iCE40UL1K device can be disconnected from the 12 MHz oscillator using J16. This is necessary, for example, when iCE40 Ultra Lite device ball D2 is mistakenly programmed as an output and prevents the FTDI USB interface from operating.

## Board Power

The board provides the following power features:

- Board Power
  - Board power is derived from the USB connection.
  - D9 Green LED indicates Board Power
- iCE40 UltraLite VCC
  - Onboard 1.2 V supply
  - ICC can be measured across the series resistor R4 (1 Ohm) at test points +1.2 V and VCC
- iCE40 UltraLite VCCIO
  - Onboard 3.3 V supply
  - ICC0 can be measured across the series resistor R2 (10Ohm) at test points TP4 and VCCIO0
  - ICC1 can be measured across the series resistor R3 (10Ohm) at test points TP9 and VCCIO1
  - ICC2 can be measured across the series resistor R5 (10Ohm) at test points TP6 and VCCIO2

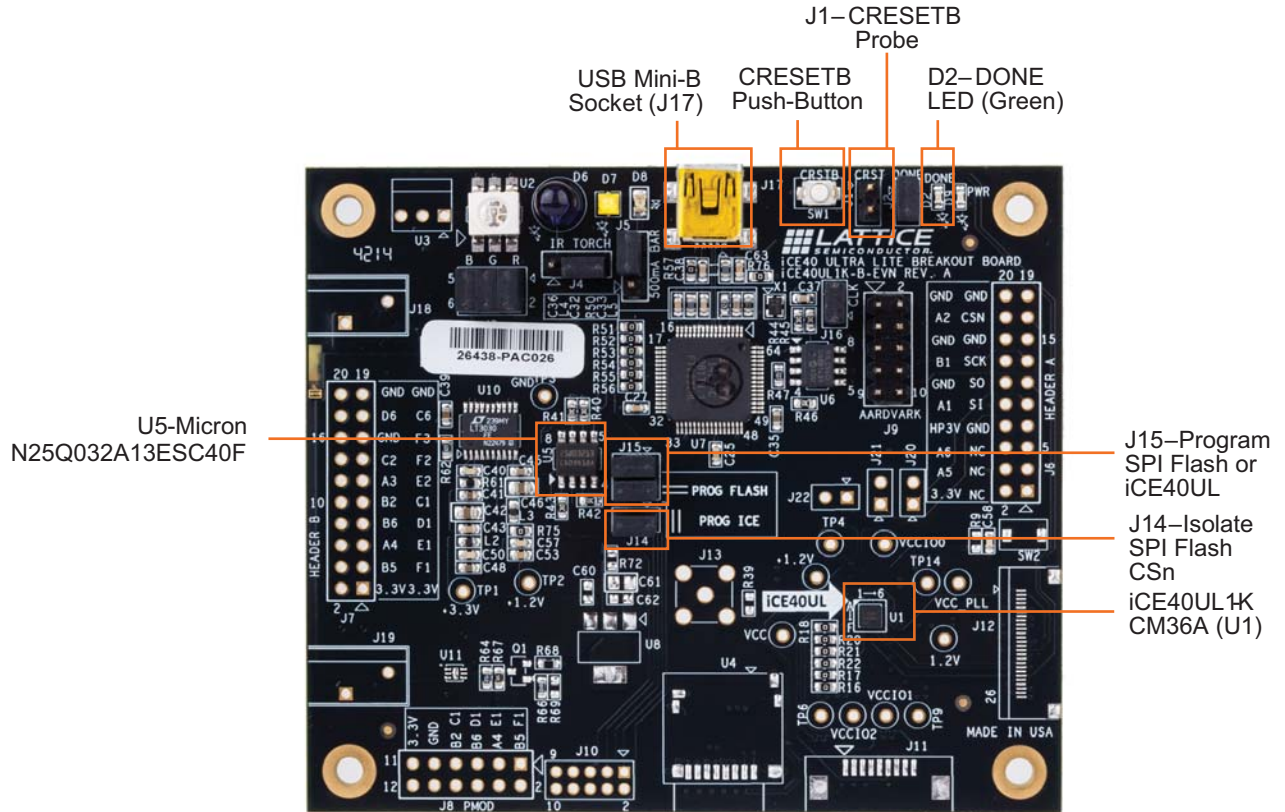
## Board Configuration and Programming

The board allows for programming of the iCE40 UltraLite or the SPI Flash:

- SPI Flash Programming J15 shunt pins 1-3 and 2-4 (Default shunted)
  - U5 Micron Technology Inc part number N25Q032A13ESC40F
- iCE40 Ultra Configuration or Programming J15 shunt pins 1-2 and 3-4
  - U1 iCE40UL1K-CM36A
- CRESETB can be asserted by pushing SW1
  - Can be probed with J1
- DONE LED D2
  - Can be probed with J2 (default shunted)

Details of the iCE40 UltraLite Board for use in programming are shown in Figure 3.

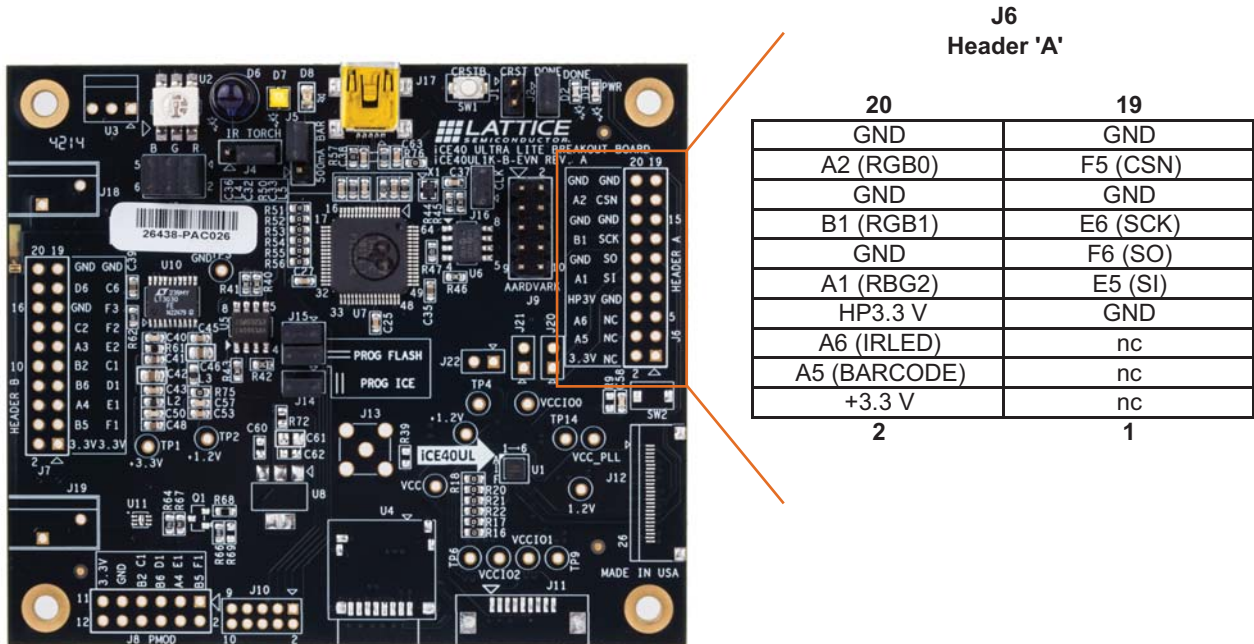
**Figure 3. Configuration and Programming Details**



## Headers and Test Connections

The board features a number of headers and test connections which provide access to the iCE40 Ultra-Lite I/Os, as shown in Figure 4, Figure 5 and Figure 6 below:

**Figure 4. J6 Header 'A' Breakouts**



**Figure 5. J7 Header 'B' Breakouts**

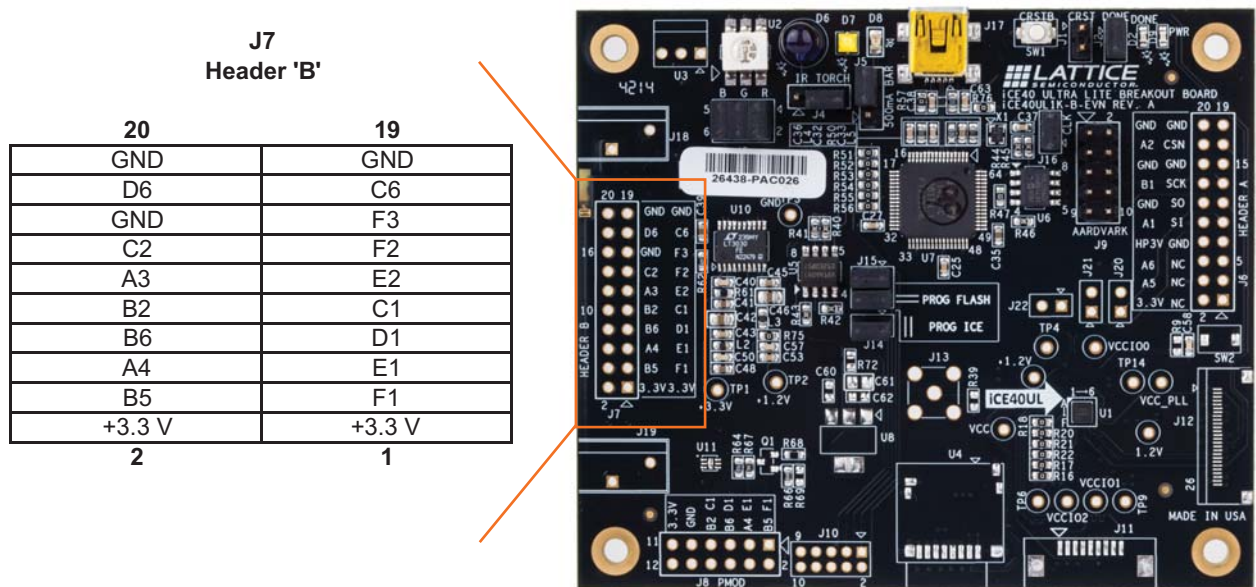
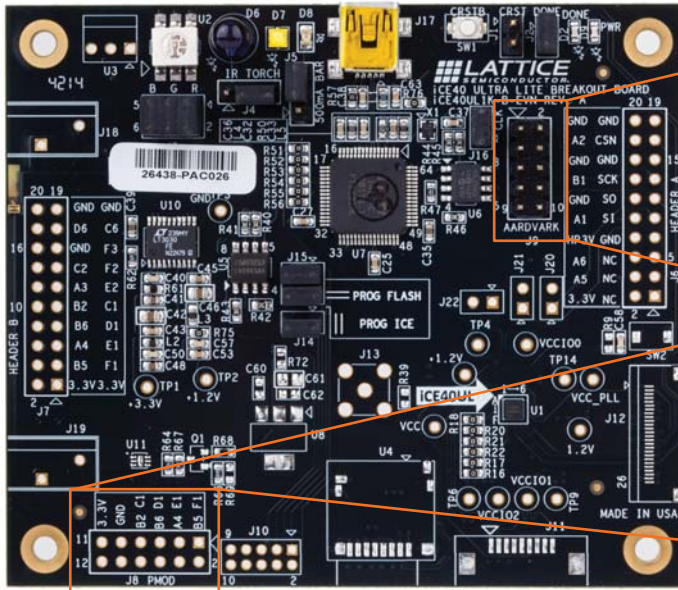


Figure 6. J9 Aardvark and J8 PMOD Connector



**J9**  
Aardvark

1	2
nc	GND
nc	nc
FLASH_MISO	nc
ICE_SCK	FLASH_MOSI
ICE_CSN	GND
9	10

**J8**  
PMOD

12	11
+3.3 V	+3.3 V
GND	GND
B2	C1
B6	D1
A4	E1
B5	F1
2	1

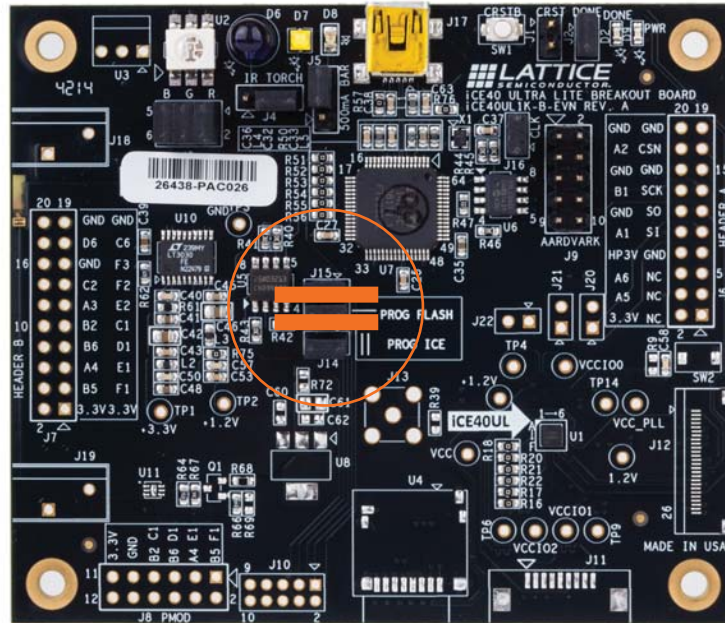


## RGB LED Demonstration Design and Software GUI

The iCE40 UltraLite Breakout Board can demonstrate a complete controller for an RGB LED. These are the steps necessary to run the demonstration.

1. Ensure that the RGB LED GUI is installed.
2. Make sure the jumpers on J15 are both in the horizontal position. This is the default pins 1-3 and 2-4 shorted together.

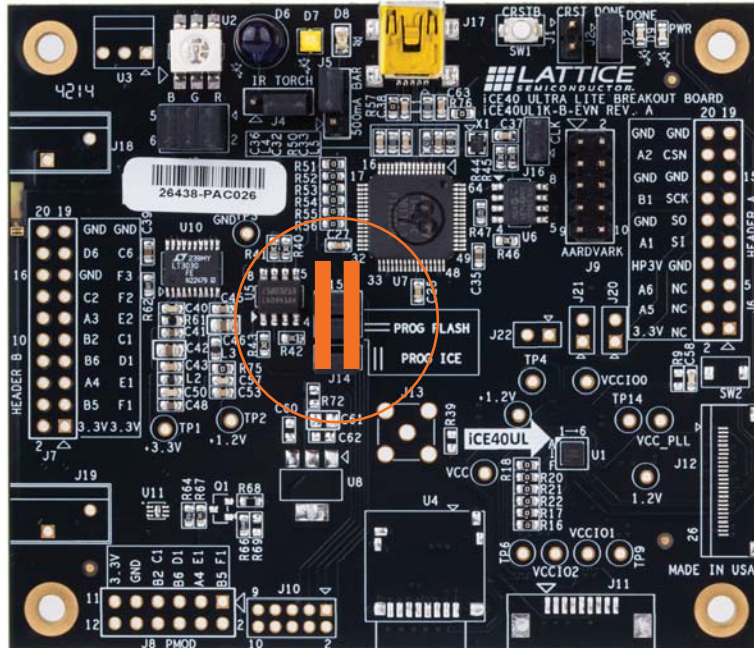
**Figure 7. SPI Flash Selection (Horizontal) for J15**



3. Connect the iCE40 UltraLite breakout board via the USB cable to a PC or MAC.

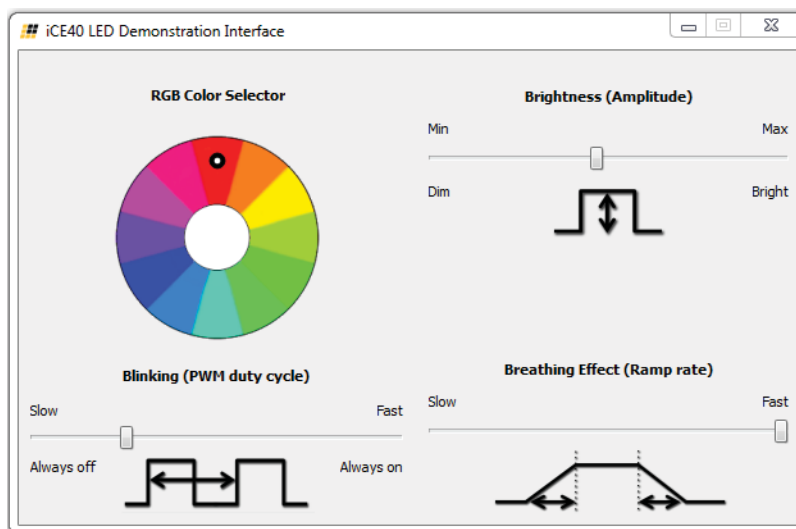
- After the iCE40 UltraLite device has initialized and the RGB LED is illuminated RED, change the J15 jumper positions to vertical, shorting pins 1-2 and 3-4. This is required to allow the USB port to communicate with the iCE40 UltraLite device.

**Figure 8. iCE Selection (Vertical) for J15**



- Start the RGB GUI on the PC or MAC.

**Figure 9. iCE40 UltraLite LED Demonstration Interface**



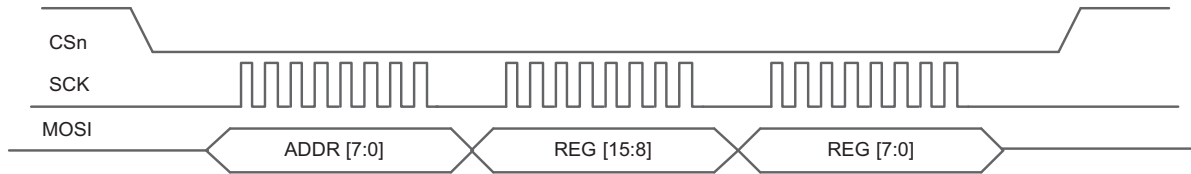
Now you can control the RGB LED on the iCE40 UltraLite Breakout Board. You can set the color, brightness, blinking rate as well as breathing.

## GUI Serial Communication Interface

### LED Control via SPI

The Software GUI demonstration program communicates with the iCE40 UltraLite device using a SPI serial communication channel. The SPI interface (mode 0) control link is implemented using a simple write-only protocol (see Figure 10).

**Figure 10. SPI Physical Transaction**



### SPI Protocol

Data on the MOSI serial line is transmitted MSB first.

Addr[7:0] – Controls which of the 16 bits are updated with REG data.

Note: Unspecified REG bits must be written, but are ignored.

Addr	Bits Written	Bit Position
0x13	REG[3:0]	-----dddd
0x14	REG[7:4]	-----cccc---
0x15	REG[11:8]	----bbbb-----
0x16	REG[15:12]	aaaa-----
0x19	REG[15:0]	aaaabbbbccccdddd

REG[15:0] – Consists of four control fields.

Field	Bit Positions	Function
aaaa	REG[15:12]	RGB Color[3:0]
bbbb	REG[11:8]	Brightness[3:0]
cccc	REG[7:4]	Breathe Ramp [3:0]
dddd	REG[3:0]	Blink Rate [3:0]

## Register Definitions

Default setting (hardware, software) is denoted by (\*).

RGB Color[3:0]	Color	Color Code
0000*	Red	#FF0000
0001	Orange	#FF7F00
0010	Yellow	#FFFF00
0011	Chartreuse	#7FFF00
0100	Green	#00FF00
0101	Spring Green	#00FF7F
0110	Cyan	#00FFFF
0111	Azure	#007FFF
1000	Blue	#0000FF
1001	Violet	#7F00FF
1010	Magenta	#FF00FF
1011	Rose	#FF007F
1100	—	
1101	—	
1110	—	
1111	White	#FFFFFF


Brightness[3:0]	Level (%)
0000	6.25(dim)
0001	12.5
0010	18.75
0011	25
0100	31.25
0101	37.5
0110	43.75
0111*	50
1000	56.25
1001	62.5
1010	68.75
1011	75
1100	81.25
1101	87.5
1110	93.75
1111	100 (bright)

Breathe Ramp [3:0]	Factor
0000*	.0x (fast)
0001	.063x
0010	.125x
0011	.25x
0100	.5x
0101	1x
0110	2x
0111	4x (slow)
1000	—
1001	—
1010	—
1011	—
1100	—
1101	—
1110	—
1111	—

Blink Rate [3:0]	Off Time (s) <sup>1</sup>
0000	Always On
0001	1/16 (fast)
0010	1/8
0011	1/4
0100	1/2
0101*	1
0110	2
0111	4
1000	Always Off
1001	—
1010	—
1011	—
1100	—
1101	—
1110	—
1111	—

1. By default, the LED "On-Time" is fixed at approximately one second.

## Ordering Information

Description	Ordering Part Number	China RoHS Environment-Friendly Use Period (EFUP)
iCE40 UltraLite Breakout Board	ICE40UL1K-B-EVN	

## Technical Support Assistance

Submit a technical support case via [www.latticesemi.com/techsupport](http://www.latticesemi.com/techsupport).

## Revision History

Date	Version	Change Summary
March 2017	1.1	Updated <a href="#">Appendix A. Schematic Diagrams</a> section. Indicated "Bank 2" in Figure 12, iCE40 ULtraLite.
		Updated <a href="#">Technical Support Assistance</a> information.
		Updated document template.
December 2014	1.0	Initial release.

© 2017 Lattice Semiconductor Corp. All Lattice trademarks, registered trademarks, patents, and disclaimers are as listed at [www.latticesemi.com/legal](http://www.latticesemi.com/legal). All other brand or product names are trademarks or registered trademarks of their respective holders. The specifications and information herein are subject to change without notice.

## Appendix A. Schematic Diagrams

Figure 11. System Diagram

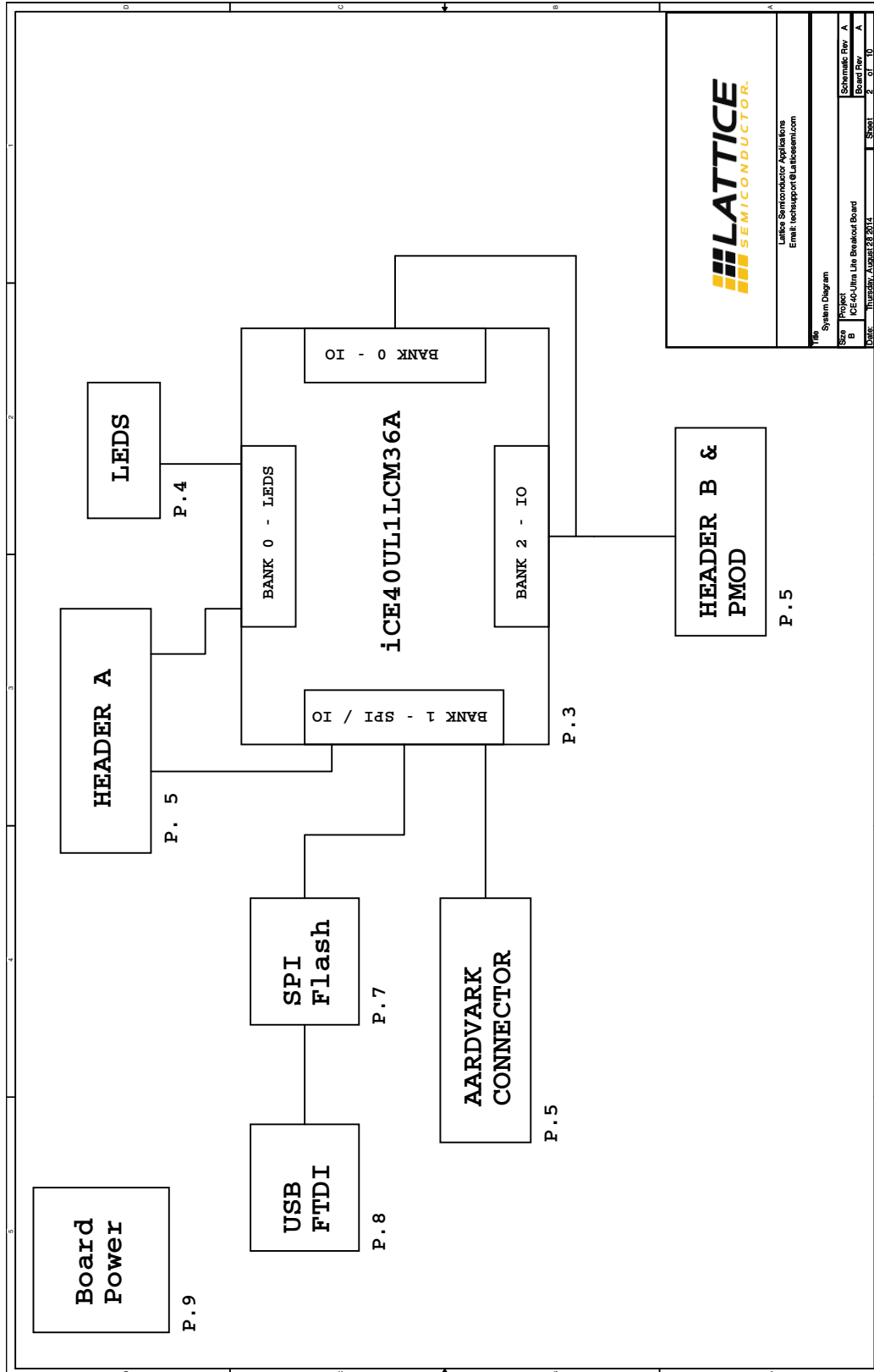






Figure 13. LEDS

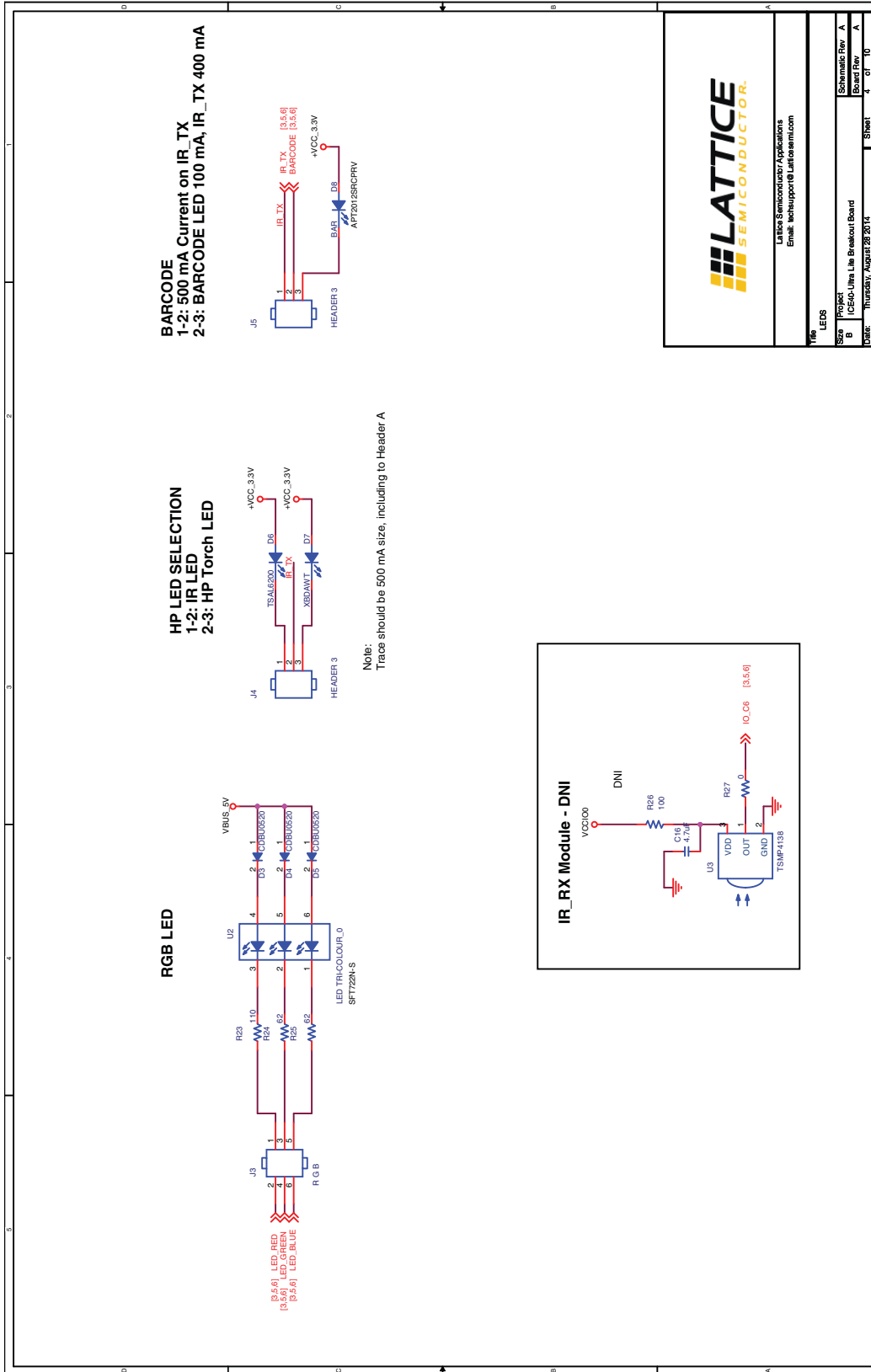
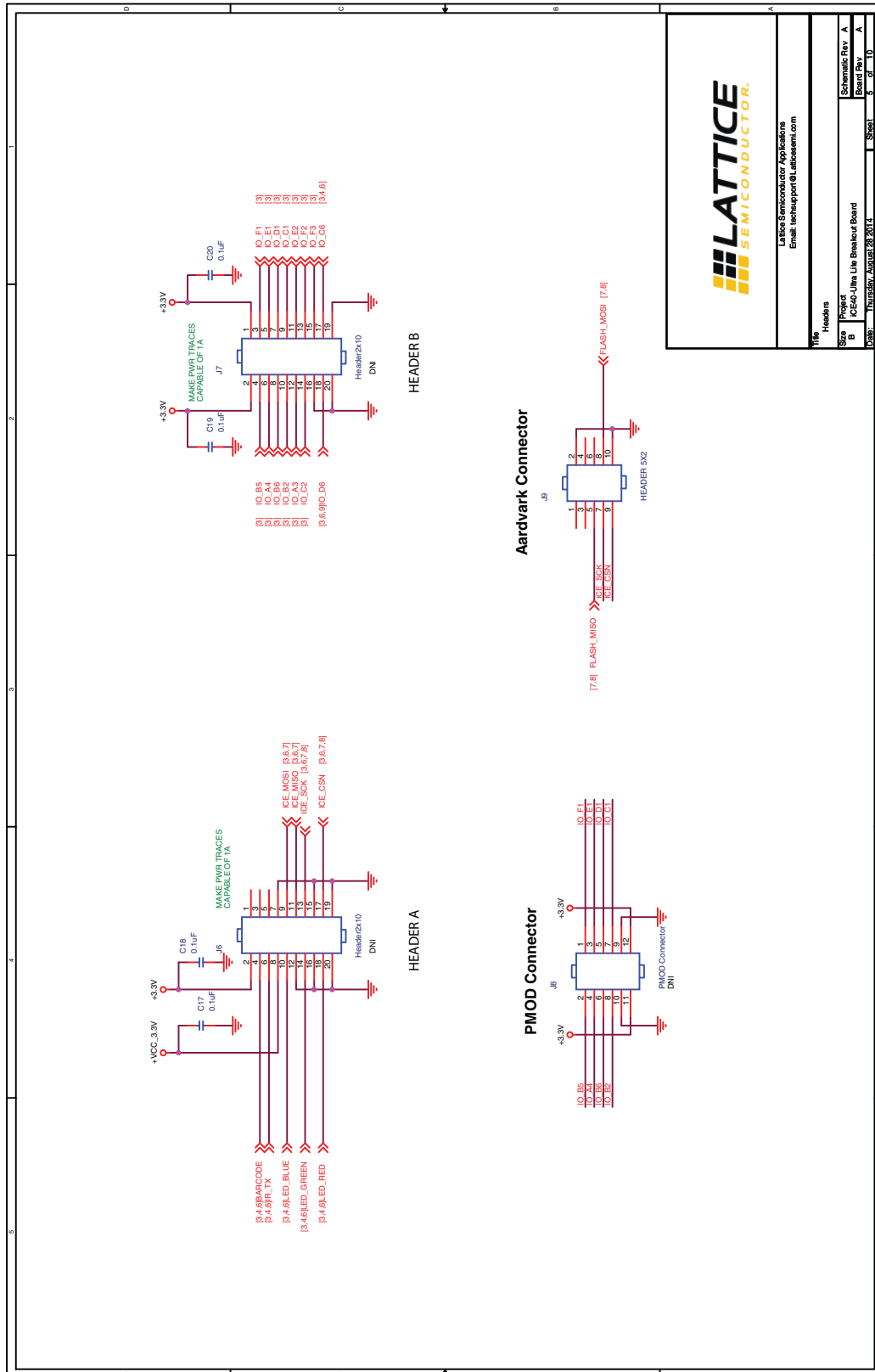


Figure 14. Headers



**LATTICE**  
SEMICONDUCTOR.

Lattice Semiconductor Applications  
Email: techsupport@lattice.com

Title: Headers

Project: iCE40-Ultra Lite Breakout Board

Size: 8

Date: Thursday, August 28, 2014

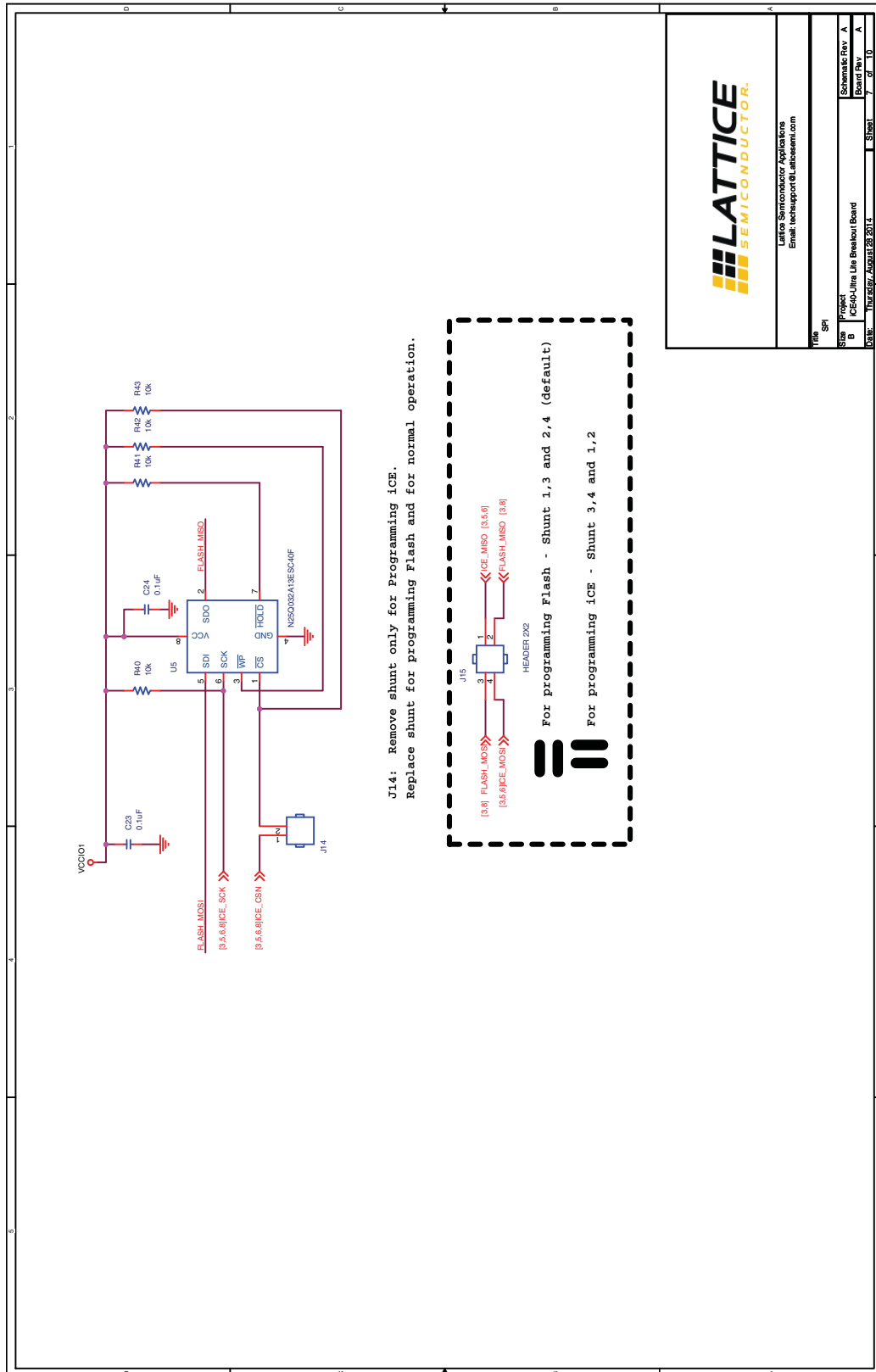
Sheet: 6 of 10

Schematic Rev: A

Board Rev: A

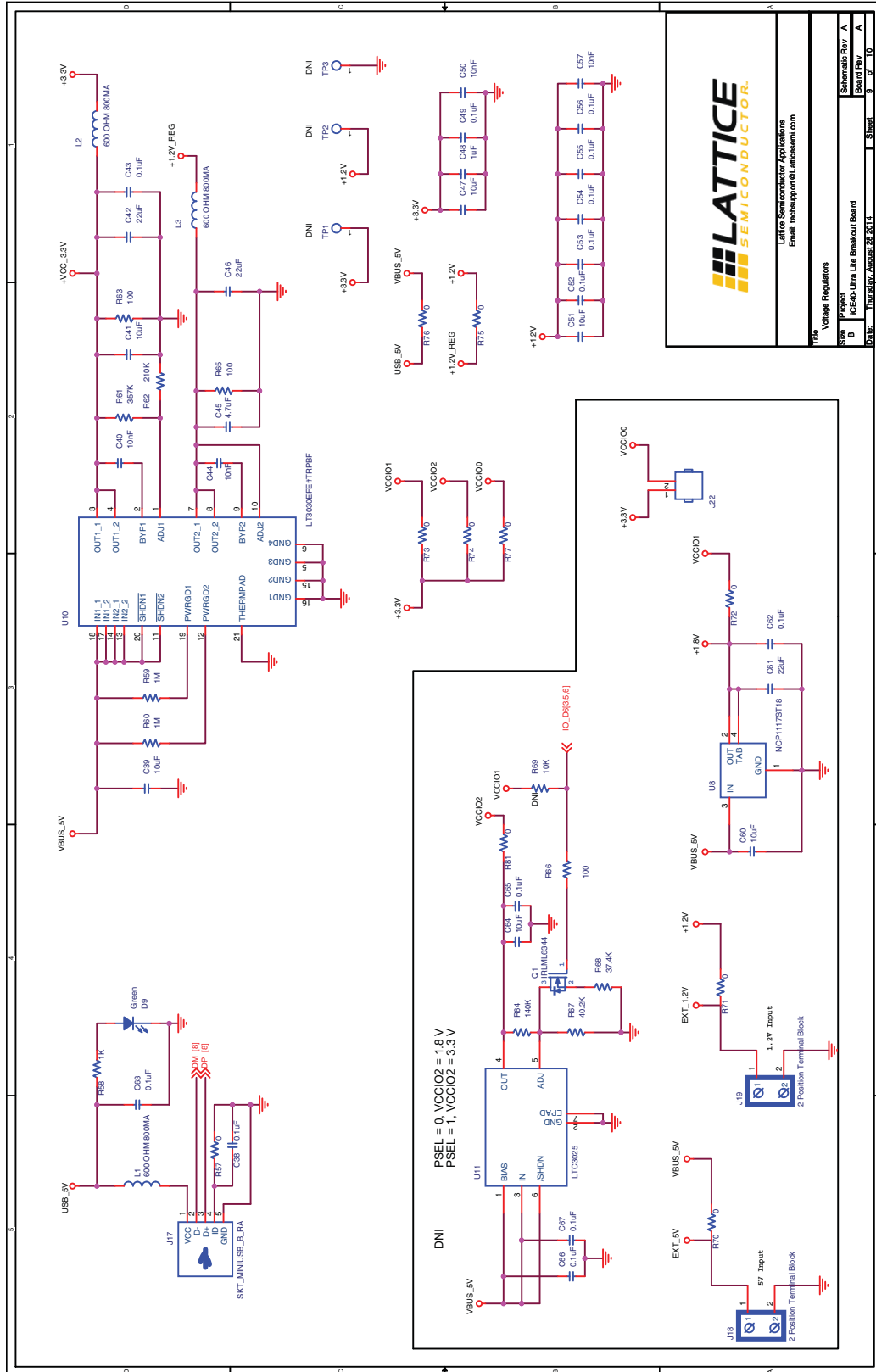


Figure 16. SPI





**Figure 18. Voltage Regulators**





**Appendix B. Bill of Materials**

Item	Quantity	Reference	Value	Manufacturer	Mfg P/N	Populated
1	5	C1,C4,C7,C10,C14	0.1 uF	Kemet	C0603C104K4RACTU	Yes
2	5	C2,C5,C8,C11,C15	10 nF	Kemet	C0603C103K4RACTU	Yes
3	4	C3,C6,C9,C13	1 uF	Murata	GRM188R61A105KA61D	Yes
4	17	C12,C17,C18,C19,C20,C23,C24,C37,C38,C43,C49,C52,C53,C54,C55,C56,C63	0.1 uF	Kemet	C0603C104K4RACTU	Yes
5	1	C16	4.7 uF	Murata	GRM188R60J475KE19D	—
6	1	C21	0.1 uF	Kemet	C0603C104K4RACTU	—
7	1	C22	10 nF	Kemet	C0603C103K4RACTU	—
8	9	C25,C26,C27,C28,C29,C30,C32,C34,C36	0.1 uF	Kemet	C0603C104K4RACTU	Yes
9	2	C31,C33	4.7 uF	Murata	GRM188R60J475KE19D	Yes
10	1	C35	10 uF	Taiyo Yuden	LMK107BBJ106MAHT	Yes
11	4	C39,C41,C47,C51	10 uF	Taiyo Yuden	LMK107BBJ106MAHT	Yes
12	6	C40,C44,C50,C57,C58,C59	10 nF	Kemet	C0603C103K4RACTU	Yes
13	2	C42,C46	22 uF	TDK	C2012X5R1A226M125AB	Yes
14	1	C45	4.7 uF	Murata	GRM188R60J475KE19D	Yes
15	1	C48	1uF	Murata	GRM188R61A105KA61D	Yes
16	2	C60,C64	10 uF	Taiyo Yuden	LMK107BBJ106MAHT	—
17	1	C61	22 uF	TDK	C2012X5R1A226M125AB	—
18	4	C62,C65,C66,C67	0.1 uF	Kemet	C0603C104K4RACTU	—
19	4	D1,D3,D4,D5	CDBU0520	Comchip	CDBU0520	Yes
20	2	D2,D9	Green	Osram	LG L29K-G2J1-24-Z	Yes
21	1	D6	TSAL6200	Vishay	TSAL6200	Yes
22	1	D7	XBDAWT	Cree	XBDAWT-00-0000-00000LCE3	Yes
23	1	D8	BAR	Kingbright Corp	APT2012SRCPRV	Yes
24	1	J1	CRSTB	FCI	77311-801-02LF	Yes
25	1	J2	CDONE	FCI	77311-801-02LF	Yes
26	1	J3	0.1" Header 3 x 2	—	—	Yes
27	2	J4,J5	0.1" Header 3 x 1	—	—	Yes
28	2	J6,J7	0.1" Header 10 x 2	Samtec	MTSW-110-08-G-D-265	—
29	1	J8	0.1" Header 6 x 2	—	—	—
30	1	J9	0.1" Header 5 x 2	—	—	Yes
31	1	J10	Header 5x2 (2 mm pitch)	Molex	087758-1016	—
32	1	J11	9 pin FPC connector	Molex Inc	522070960	—
33	1	J12	26 pin FPC connector	Omron	XF2M-2615-1A	—



Item	Quantity	Reference	Value	Manufacturer	Mfg P/N	Populated
34	1	J13	SMA	Molex Inc	733910060	—
35	2	J14,J16	0.1" Header 2 x 1	FCI	77311-801-02LF	Yes
36	1	J15	0.1" Header 2 x 2	—	—	Yes
37	1	J17	SKT_MINIU SB_B_RA	Neltron	5075BMR-05-SM-CR	Yes
38	2	J18,J19	2 Position Terminal Block	Phoenix Contact	1990009	—
39	3	J20,J21,J22	0.1" Header 2 x 1	FCI	77311-801-02LF	—
40	3	L1,L2,L3	600 Ohm 800 mA	Murata	BLM18HE601SN1D / BLM18AG601SN1D	Yes
41	2	L4,L5	600 Ohm 800 mA	Murata	BLM18HE601SN1D / BLM18AG601SN1D	Yes
42	1	Q1	IRLML6344	IR	IRLML6344TRPBF	—
43	2	R1,R4	1	Panasonic	ERJ-3RQF1R0V	Yes
44	3	R2,R3,R5	1	Panasonic	ERJ-3RQF1R0V	Yes
45	1	R6	100	Vishay Dale	CRCW0603100RFKEAHP	Yes
46	5	R7,R40,R41,R42,R43	10k	Panasonic	ERJ-3EKF1002V	Yes
47	1	R8	402	Panasonic	ERJ-3EKF4020V	Yes
48	1	R9	10k	Panasonic	ERJ-3EKF1002V	—
49	18	R10,R11,R12,R13,R14,R15,R16,R17,R18,R20,R21,R22,R51,R52,R53,R54,R55,R56	0	Panasonic	ERJ-3GEY0R00V	Yes
50	2	R19,R48	2.2 k	Yageo	RC0603FR-072K2L	—
51	1	R23	110	Panasonic	ERJ-3EKF1100V	Yes
52	1	R24	62	Panasonic	ERJ-3EKF62R0V	Yes
53	1	R25	62	Panasonic	ERJ-3EKF62R0V	Yes
54	1	R26	100	Panasonic	ERJ-3EKF1000V	—
55	10	R27,R35,R36,R37,R38,R39,R70,R71,R72,R81	0	Panasonic	ERJ-3GEY0R00V	—
56	7	R28,R29,R30,R31,R32,R33,R34	10 k	Panasonic	ERJ-3EKF1002V	—
57	3	R44,R45,R46	10 k	Panasonic	ERJ-3EKF1002V	Yes
58	3	R47,R49,R50	2.2 k	Yageo	RC0603FR-072K2L	Yes
59	3	R57,R75,R76	0	Panasonic	ERJ-3GEY0R00V	Yes
60	1	R58	1 K	Vishay Dale	CRCW06031K00FKEA	Yes
61	2	R59,R60	1 M	Vishay Dale	CRCW04021M00JNED	Yes
62	1	R61	357 K	Panasonic	ERJ-3EKF3573V	Yes
63	1	R62	210 K	Panasonic	ERJ-3EKF2103V	Yes
64	3	R63,R65,R66	100	Panasonic	ERJ-3EKF1000V	Yes
65	1	R64	140 K	Yageo	RC0603FR-07140KL	Yes
66	1	R67	40.2 K	Panasonic	ERJ-3EKF4022V	Yes

Item	Quantity	Reference	Value	Manufacturer	Mfg P/N	Populated
67	1	R68	37.4 K	Panasonic	ERJ-3EKF3742V	Yes
68	1	R69	10 K	Panasonic	ERJ-3EKF1002V	—
69	3	R73,R74,R77	0	Panasonic	ERJ-3GEY0R00V	Yes
70	1	R78	0	Panasonic	ERJ-3GEY0R00V	—
71	1	R84	0	Panasonic	ERJ-3GEY0R00V	—
72	1	SW1	CRSTB	E-Switch	TL1015AF160QG	Yes
73	1	SW2	SW2	E-Switch	TL1015AF160QG	—
74	1	U1	iCE40UL1K-CM36A	Lattice	iCE40UL1K-CM36A	Yes
75	1	U2	LED TRI-COLOUR_0	Seoul Semiconductor Inc	SFT722N-S	Yes
76	1	U3	TSMP4138	Vishay	TSMP4138	—
77	1	U4	MicroSD 114-00841-68	Amphenol	114-00841-68	—
78	1	U5	N25Q032A13ESC40F	Micron	N25Q032A13ESC40F	Yes
79	1	U6	93LC56-SO8	Microchip	93LC56CT-I/SN	Yes
80	1	U7	FT2232HL	FTDI	FT2232HL-REEL	Yes
81	1	U8	NCP1117S T18	ON Semiconductor	NCP1117ST18T3G	—
82	1	U10	LT3030EFE#TRPBF	Linear	LT3030EFE#TRPBF	Yes
83	1	U11	LTC3025	Linear	LTC3025EDC#TRMPBF	—
84	1	X1	12.000 MHz	SiTIME	SIT1602AC-73-33S-12.000000G	Yes

# Mouser Electronics

Authorized Distributor

Click to View Pricing, Inventory, Delivery & Lifecycle Information:

Lattice:

[ICE40UL1K-B-EVN](#)