



Small Signal Schottky Diodes



DESIGN SUPPORT TOOLS click logo to get started



MECHANICAL DATA

Case: MicroMELF

Weight: approx. 12 mg

Cathode band color: black

Packaging codes/options:

TR3/10K per 13" reel (8 mm tape), 10K/box

TR/2.5K per 7" reel (8 mm tape), 12.5K/box

FEATURES

- Integrated protection ring against static discharge
- Low capacitance
- Low leakage current
- Low forward voltage drop
- Very low switching time
- AEC-Q101 qualified
- Material categorization: for definitions of compliance please see www.vishay.com/doc?99912



RoHS
COMPLIANT
HALOGEN
FREE

APPLICATIONS

- General purpose and switching Schottky barrier diode
- HF-detector
- Protection circuit
- Diode for low currents with a low supply voltage
- Small battery charger
- Power supplies
- DC/DC converter for notebooks

PARTS TABLE				
PART	TYPE DIFFERENTIATION	ORDERING CODE	CIRCUIT CONFIGURATION	REMARKS
BAS381	$V_R = 40\text{ V}$	BAS381-TR3 or BAS381-TR	Single	Tape and reel
BAS382	$V_R = 50\text{ V}$	BAS382-TR3 or BAS382-TR	Single	Tape and reel
BAS383	$V_R = 60\text{ V}$	BAS383-TR3 or BAS383-TR	Single	Tape and reel

ABSOLUTE MAXIMUM RATINGS ($T_{amb} = 25\text{ }^\circ\text{C}$, unless otherwise specified)					
PARAMETER	TEST CONDITION	PART	SYMBOL	VALUE	UNIT
Reverse voltage		BAS381	V_R	40	V
		BAS382	V_R	50	V
		BAS383	V_R	60	V
Peak forward surge current	$t_p = 1\text{ s}$		I_{FSM}	500	mA
Repetitive peak forward current			I_{FRM}	150	mA
Forward continuous current			I_F	30	mA

THERMAL CHARACTERISTICS ($T_{amb} = 25\text{ }^\circ\text{C}$, unless otherwise specified)					
PARAMETER	TEST CONDITION	SYMBOL	VALUE	UNIT	
Junction to ambient air	On PC board 50 mm x 50 mm x 1.6 mm	R_{thJA}	320	K/W	
Junction temperature		T_j	125	$^\circ\text{C}$	
Storage temperature range		T_{stg}	-65 to +150	$^\circ\text{C}$	



ELECTRICAL CHARACTERISTICS ($T_{amb} = 25\text{ }^{\circ}\text{C}$, unless otherwise specified)						
PARAMETER	TEST CONDITION	SYMBOL	MIN.	TYP.	MAX.	UNIT
Forward voltage	$I_F = 0.1\text{ mA}$	V_F			330	mV
	$I_F = 1\text{ mA}$	V_F			410	mV
	$I_F = 15\text{ mA}$	V_F			1000	mV
Reverse current	$V_R = V_{Rmax.}$	I_R			200	nA
Diode capacitance	$V_R = 1\text{ V}, f = 1\text{ MHz}$	C_D			1.6	pF

TYPICAL CHARACTERISTICS ($T_{amb} = 25\text{ }^{\circ}\text{C}$, unless otherwise specified)

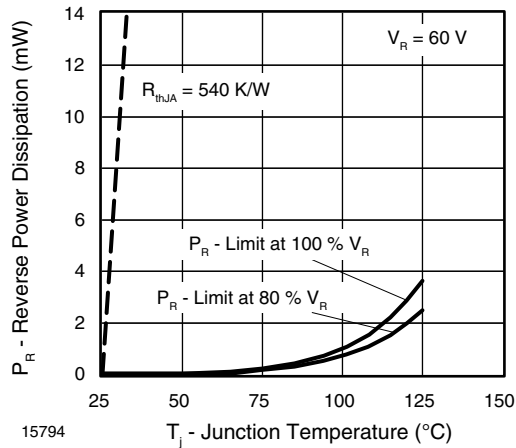

Fig. 1 - Max. Reverse Power Dissipation vs. Junction Temperature

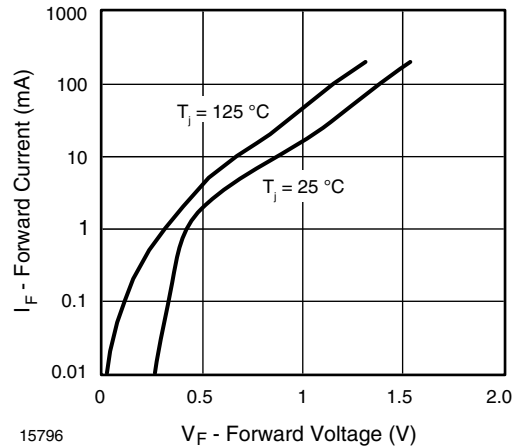

Fig. 3 - Forward Current vs. Forward Voltage

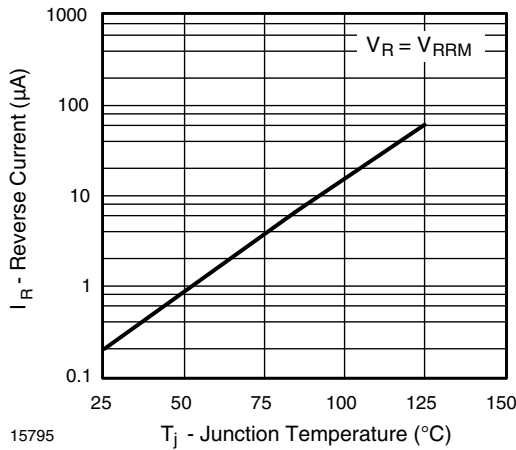

Fig. 2 - Reverse Current vs. Junction Temperature

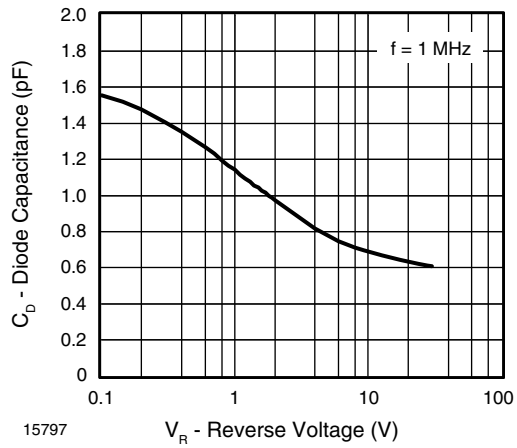

Fig. 4 - Diode Capacitance vs. Reverse Voltage

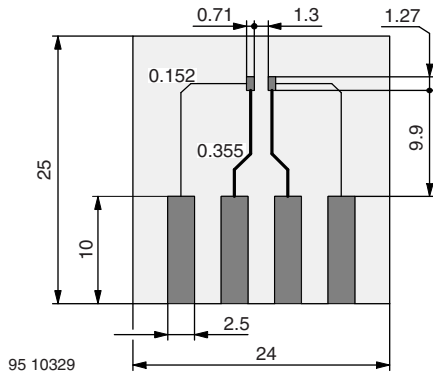
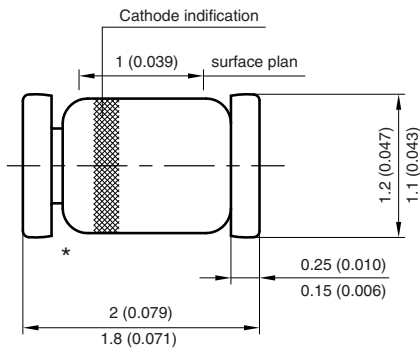
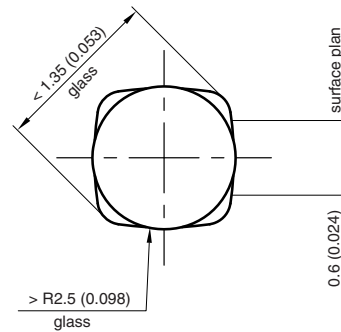

Fig. 5 - Board for R_{thJA} Definition (in mm)

PACKAGE DIMENSIONS in millimeters (inches): **MicromELF**



* The gap between plug and glass can be either on cathode or anode side



Foot print recommendation:

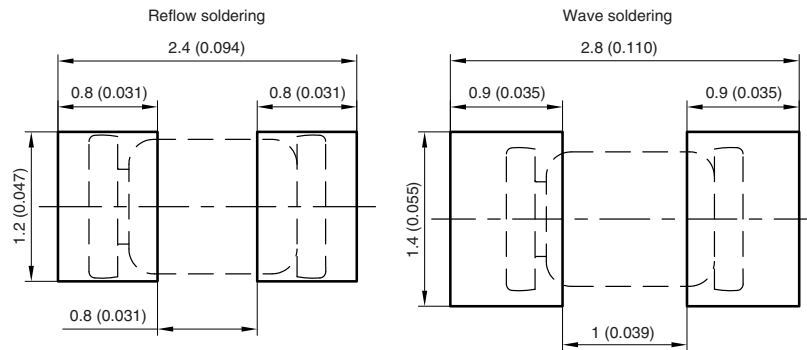

Created - Date: 26.July.1996
 Rev. 13 - Date: 07.June.2006
 Document no.:6.560-5007.01-4
 96 12072



Disclaimer

ALL PRODUCT, PRODUCT SPECIFICATIONS AND DATA ARE SUBJECT TO CHANGE WITHOUT NOTICE TO IMPROVE RELIABILITY, FUNCTION OR DESIGN OR OTHERWISE.

Vishay Intertechnology, Inc., its affiliates, agents, and employees, and all persons acting on its or their behalf (collectively, "Vishay"), disclaim any and all liability for any errors, inaccuracies or incompleteness contained in any datasheet or in any other disclosure relating to any product.

Vishay makes no warranty, representation or guarantee regarding the suitability of the products for any particular purpose or the continuing production of any product. To the maximum extent permitted by applicable law, Vishay disclaims (i) any and all liability arising out of the application or use of any product, (ii) any and all liability, including without limitation special, consequential or incidental damages, and (iii) any and all implied warranties, including warranties of fitness for particular purpose, non-infringement and merchantability.

Statements regarding the suitability of products for certain types of applications are based on Vishay's knowledge of typical requirements that are often placed on Vishay products in generic applications. Such statements are not binding statements about the suitability of products for a particular application. It is the customer's responsibility to validate that a particular product with the properties described in the product specification is suitable for use in a particular application. Parameters provided in datasheets and / or specifications may vary in different applications and performance may vary over time. All operating parameters, including typical parameters, must be validated for each customer application by the customer's technical experts. Product specifications do not expand or otherwise modify Vishay's terms and conditions of purchase, including but not limited to the warranty expressed therein.

Except as expressly indicated in writing, Vishay products are not designed for use in medical, life-saving, or life-sustaining applications or for any other application in which the failure of the Vishay product could result in personal injury or death. Customers using or selling Vishay products not expressly indicated for use in such applications do so at their own risk. Please contact authorized Vishay personnel to obtain written terms and conditions regarding products designed for such applications.

No license, express or implied, by estoppel or otherwise, to any intellectual property rights is granted by this document or by any conduct of Vishay. Product names and markings noted herein may be trademarks of their respective owners.

Mouser Electronics

Authorized Distributor

Click to View Pricing, Inventory, Delivery & Lifecycle Information:

[Vishay:](#)

[BAS381-TR](#) [BAS381-TR3](#) [BAS382-TR](#) [BAS382-TR3](#) [BAS383-TR](#) [BAS383-TR3](#)