

# IRF9321PbF

HEXFET® Power MOSFET

<b>V<sub>DS</sub></b>	<b>-30</b>	<b>V</b>
<b>R<sub>DS(on)</sub> max</b> (@ V <sub>GS</sub> = -10V)	<b>7.2</b>	<b>mΩ</b>
<b>R<sub>DS(on)</sub> max</b> (@ V <sub>GS</sub> = -4.5V)	<b>11.2</b>	<b>mΩ</b>
<b>Q<sub>g</sub> (typical)</b>	<b>34</b>	<b>nC</b>
<b>I<sub>D</sub></b> (@ T <sub>A</sub> = 25°C)	<b>-15</b>	<b>A</b>

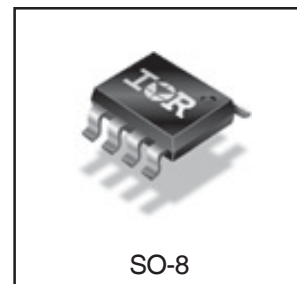
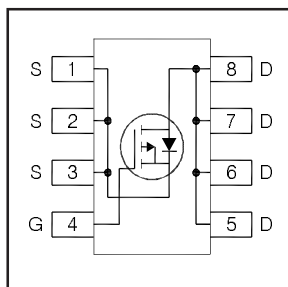

## Applications

- Charge and Discharge Switch for Notebook PC Battery Application

## Features and Benefits

### Features

Industry-Standard SO-8 Package
RoHS Compliant Containing no Lead, no Bromide and no Halogen

results in  
⇒

### Resulting Benefits

Multi-Vendor Compatibility
Environmentally Friendlier

Orderable part number	Package Type	Standard Pack		Note
		Form	Quantity	
IRF9321PbF	SO8	Tube/Bulk	95	
IRF9321TRPbF	SO8	Tape and Reel	4000	

## Absolute Maximum Ratings

	Parameter	Max.	Units
V <sub>DS</sub>	Drain-to-Source Voltage	-30	V
V <sub>GS</sub>	Gate-to-Source Voltage	±20	
I <sub>D</sub> @ T <sub>A</sub> = 25°C	Continuous Drain Current, V <sub>GS</sub> @ -10V	-15	A
I <sub>D</sub> @ T <sub>A</sub> = 70°C	Continuous Drain Current, V <sub>GS</sub> @ -10V	-12	
I <sub>DM</sub>	Pulsed Drain Current ①	-120	
P <sub>D</sub> @ T <sub>A</sub> = 25°C	Power Dissipation ④	2.5	W
P <sub>D</sub> @ T <sub>A</sub> = 70°C	Power Dissipation ④	1.6	
	Linear Derating Factor	0.02	W/°C
T <sub>J</sub>	Operating Junction and	-55 to + 150	°C
T <sub>STG</sub>	Storage Temperature Range		

Notes ① through ⑥ are on page 2

## Static @ $T_J = 25^\circ\text{C}$ (unless otherwise specified)

	Parameter	Min.	Typ.	Max.	Units	Conditions
$BV_{DSS}$	Drain-to-Source Breakdown Voltage	-30	—	—	V	$V_{GS} = 0V, I_D = -250\mu A$
$\Delta BV_{DSS}/\Delta T_J$	Breakdown Voltage Temp. Coefficient	—	0.021	—	V/ $^\circ\text{C}$	Reference to $25^\circ\text{C}, I_D = -1\text{mA}$
$R_{DS(on)}$	Static Drain-to-Source On-Resistance	—	5.9	7.2	m $\Omega$	$V_{GS} = -10V, I_D = -15A$ ③
		—	9.3	11.2		$V_{GS} = -4.5V, I_D = -12A$ ③
$V_{GS(th)}$	Gate Threshold Voltage	-1.3	-1.8	-2.4	V	$V_{DS} = V_{GS}, I_D = -50\mu A$
$\Delta V_{GS(th)}$	Gate Threshold Voltage Coefficient	—	-5.9	—	mV/ $^\circ\text{C}$	
$I_{DSS}$	Drain-to-Source Leakage Current	—	—	-1.0	$\mu A$	$V_{DS} = -24V, V_{GS} = 0V$
		—	—	-150		$V_{DS} = -24V, V_{GS} = 0V, T_J = 125^\circ\text{C}$
$I_{GSS}$	Gate-to-Source Forward Leakage	—	—	-100	nA	$V_{GS} = -20V$
	Gate-to-Source Reverse Leakage	—	—	100		$V_{GS} = 20V$
$g_{fs}$	Forward Transconductance	30	—	—	S	$V_{DS} = -10V, I_D = -12A$
$Q_g$	Total Gate Charge ⑥	—	34	—	nC	$V_{DS} = -15V, V_{GS} = -4.5V, I_D = -12A$
$Q_g$	Total Gate Charge ⑥	—	65	98	nC	$V_{GS} = -10V$
$Q_{gs}$	Gate-to-Source Charge ⑥	—	10	—		$V_{DS} = -15V$
$Q_{gd}$	Gate-to-Drain Charge ⑥	—	16	—		$I_D = -12A$
$R_G$	Gate Resistance ⑥	—	18	—	$\Omega$	
$t_{d(on)}$	Turn-On Delay Time	—	21	—	ns	$V_{DD} = -30V, V_{GS} = -4.5V$ ③
$t_r$	Rise Time	—	79	—		$I_D = -1.0A$
$t_{d(off)}$	Turn-Off Delay Time	—	185	—		$R_G = 6.8\Omega$
$t_f$	Fall Time	—	145	—		See Figs. 19a & 19b
$C_{iss}$	Input Capacitance	—	2590	—	pF	$V_{GS} = 0V$
$C_{oss}$	Output Capacitance	—	590	—		$V_{DS} = -25V$
$C_{rss}$	Reverse Transfer Capacitance	—	360	—		$f = 1.0\text{MHz}$

## Avalanche Characteristics

	Parameter	Typ.	Max.	Units
$E_{AS}$	Single Pulse Avalanche Energy ②	—	310	mJ
$I_{AR}$	Avalanche Current ①	—	-12	A

## Diode Characteristics

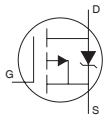
	Parameter	Min.	Typ.	Max.	Units	Conditions
$I_S$	Continuous Source Current (Body Diode)	—	—	-2.5	A	MOSFET symbol showing the integral reverse p-n junction diode. 
$I_{SM}$	Pulsed Source Current (Body Diode) ①	—	—	-120		
$V_{SD}$	Diode Forward Voltage	—	—	-1.2	V	$T_J = 25^\circ\text{C}, I_S = -2.5A, V_{GS} = 0V$ ③
$t_{rr}$	Reverse Recovery Time	—	38	57	ns	$T_J = 25^\circ\text{C}, I_F = -2.5A, V_{DD} = -24V$
$Q_{rr}$	Reverse Recovery Charge	—	24	36	nC	$di/dt = 100/\mu s$ ③

## Thermal Resistance

	Parameter	Typ.	Max.	Units
$R_{\theta JL}$	Junction-to-Drain Lead ⑤	—	20	$^\circ\text{C/W}$
$R_{\theta JA}$	Junction-to-Ambient ④	—	50	

### Notes:

- ① Repetitive rating; pulse width limited by max. junction temperature.
- ② Starting  $T_J = 25^\circ\text{C}$ ,  $L = 4.3\text{mH}$ ,  $R_G = 25\Omega$ ,  $I_{AS} = -12A$ .
- ③ Pulse width  $\leq 400\mu s$ ; duty cycle  $\leq 2\%$ .
- ④ When mounted on 1 inch square copper board.
- ⑤  $R_{\theta}$  is measured at  $T_J$  of approximately  $90^\circ\text{C}$ .
- ⑥ For DESIGN AID ONLY, not subject to production testing.

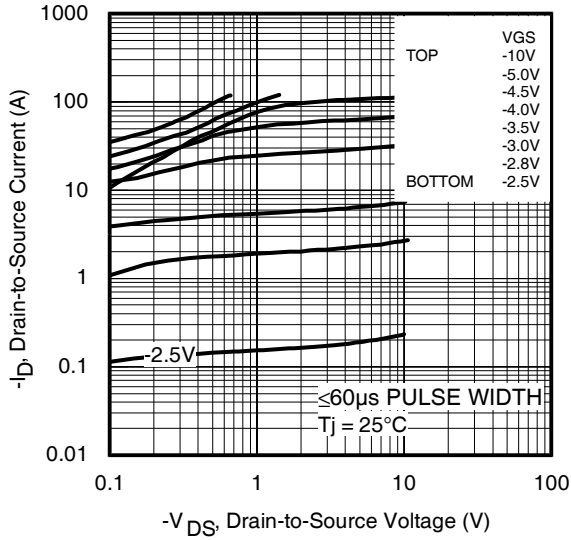

**Fig 1.** Typical Output Characteristics

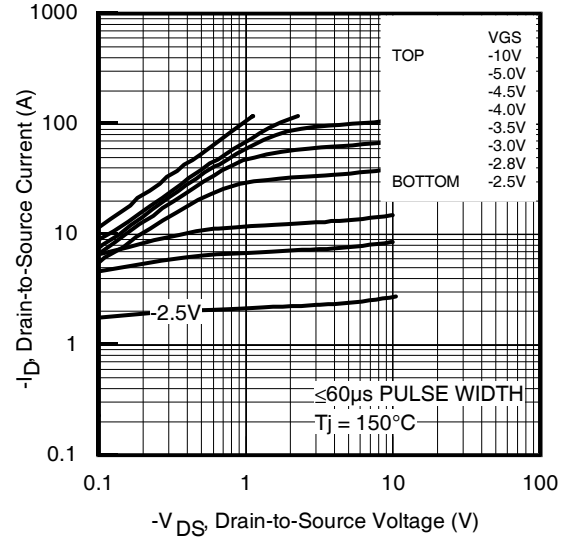

**Fig 2.** Typical Output Characteristics

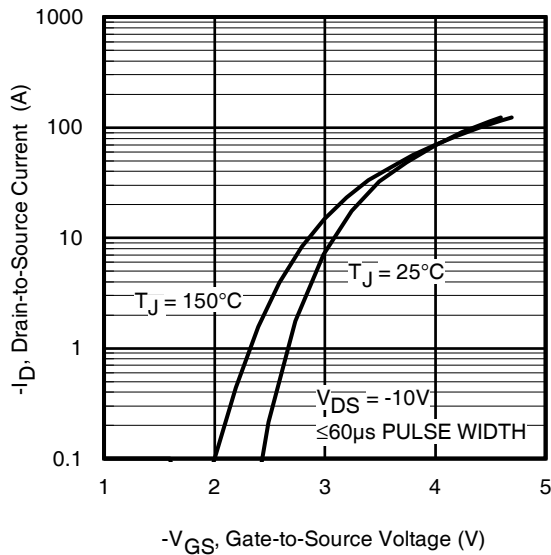

**Fig 3.** Typical Transfer Characteristics

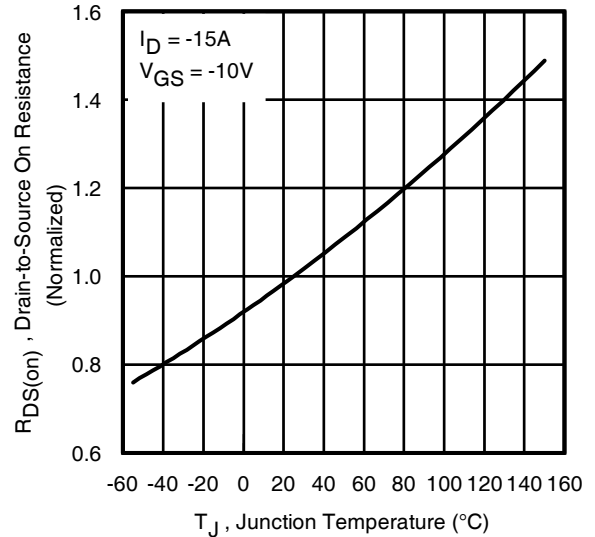

**Fig 4.** Normalized On-Resistance vs. Temperature

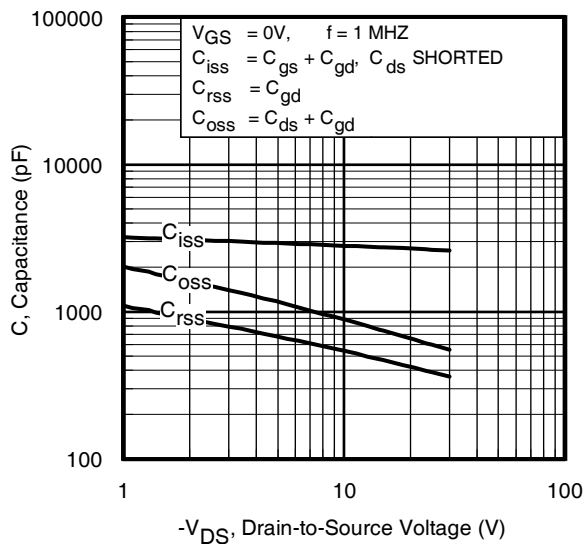

**Fig 5.** Typical Capacitance vs. Drain-to-Source Voltage  
[www.irf.com](http://www.irf.com)

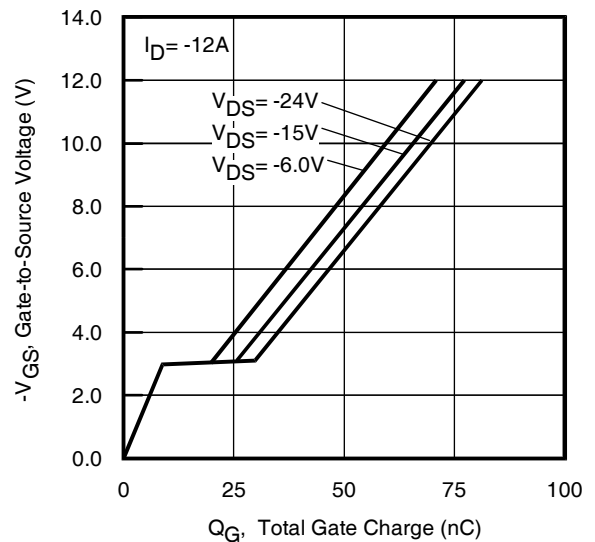

**Fig 6.** Typical Gate Charge vs. Gate-to-Source Voltage

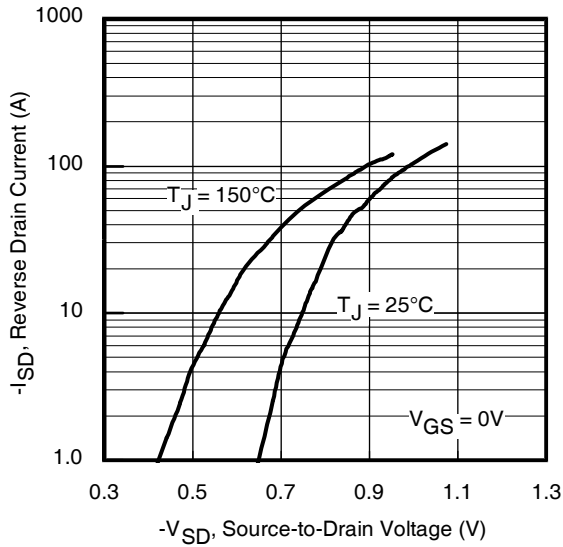

**Fig 7.** Typical Source-Drain Diode Forward Voltage

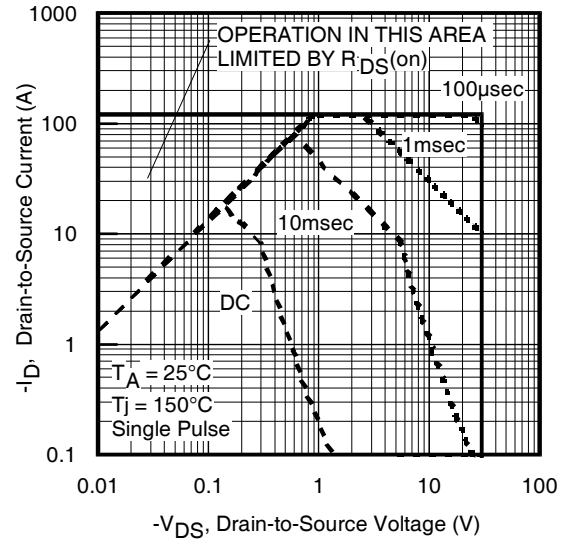

**Fig 8.** Maximum Safe Operating Area

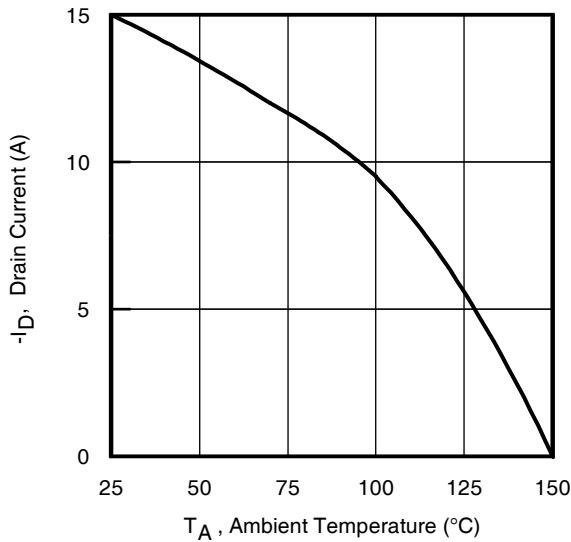

**Fig 9.** Maximum Drain Current vs. Ambient Temperature

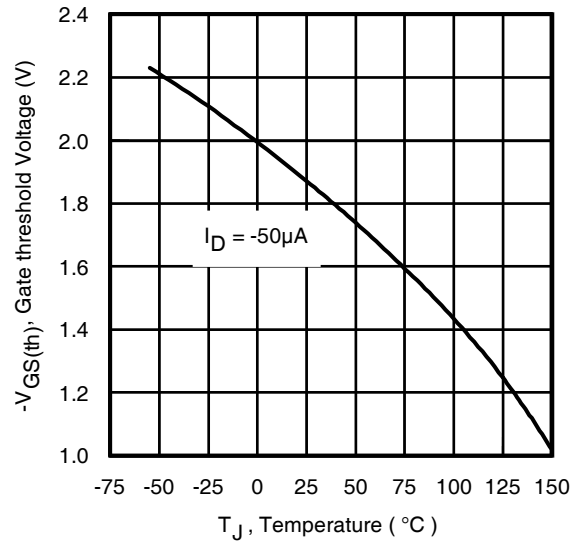

**Fig 10.** Threshold Voltage vs. Temperature

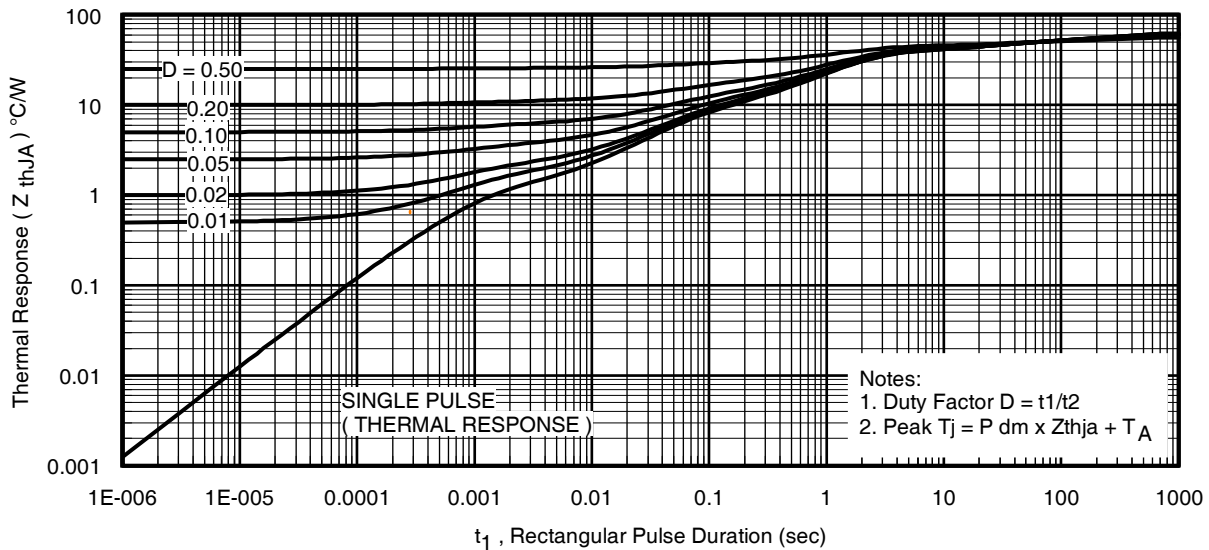

**Fig 11.** Maximum Effective Transient Thermal Impedance, Junction-to-Ambient

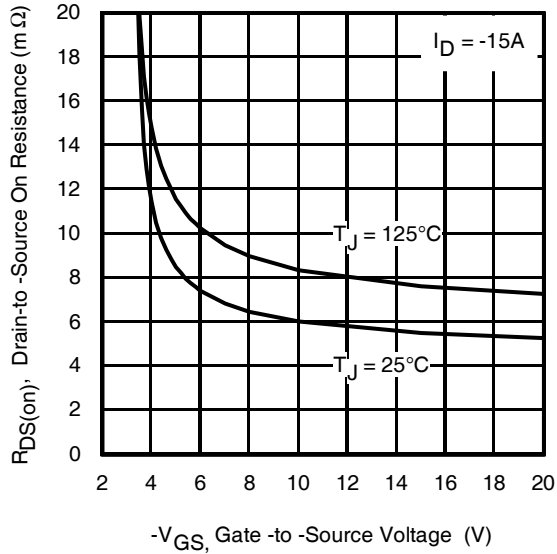

**Fig 12.** On-Resistance vs. Gate Voltage

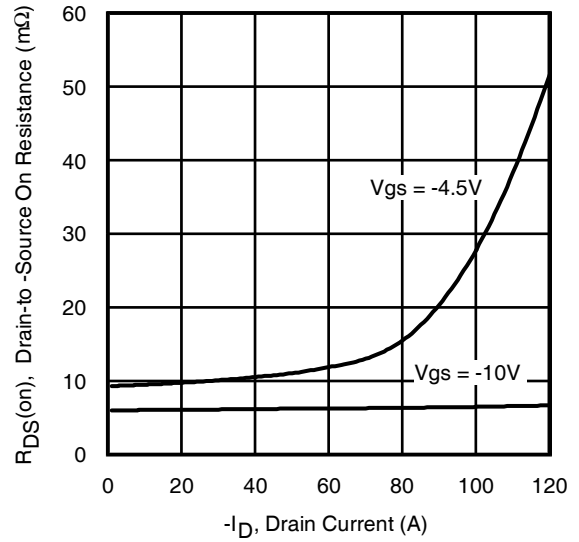

**Fig 13.** Typical On-Resistance vs. Drain Current

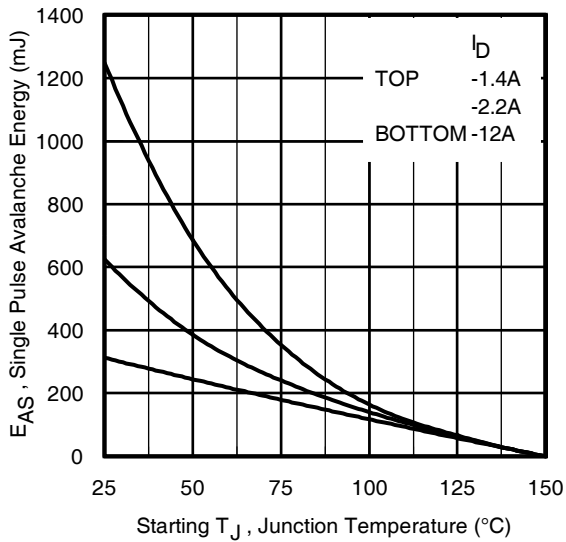

**Fig 14.** Maximum Avalanche Energy vs. Drain Current

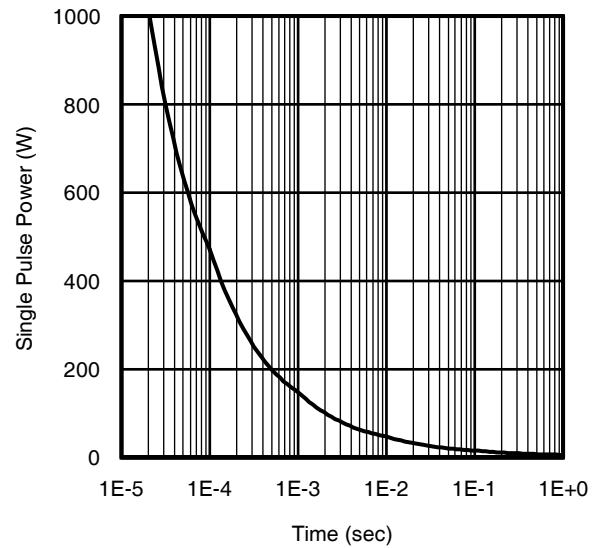

**Fig 15.** Typical Power vs. Time

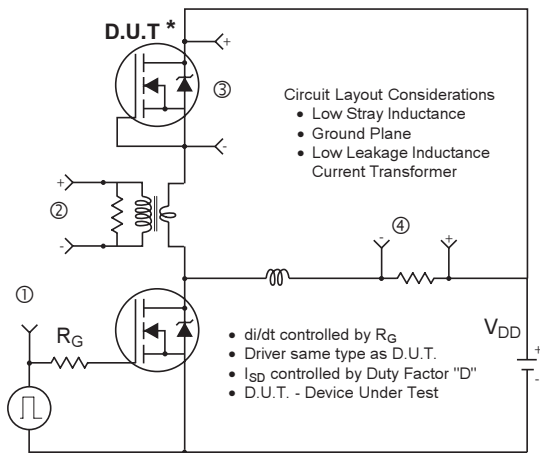

\* Reverse Polarity of D.U.T for P-Channel

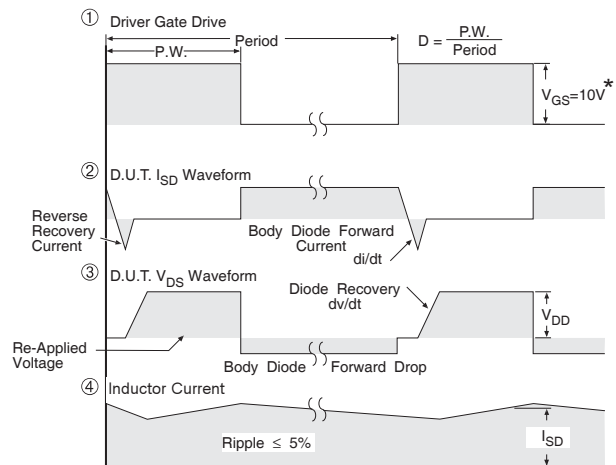

\*  $V_{GS} = 5V$  for Logic Level Devices

**Fig 16.** Diode Reverse Recovery Test Circuit for P-Channel HEXFET® Power MOSFETs

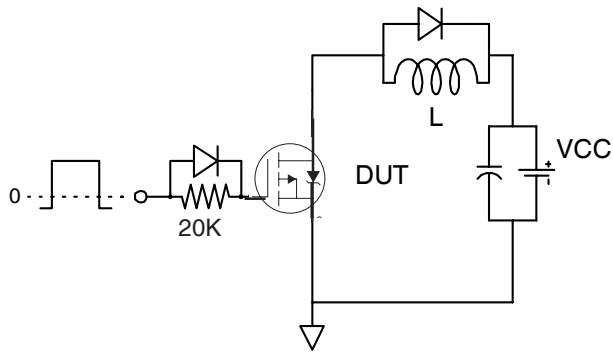

**Fig 17a.** Gate Charge Test Circuit



**Fig 17b.** Gate Charge Waveform

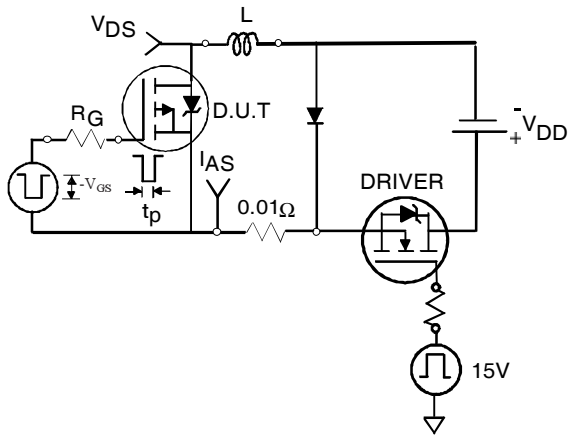

**Fig 18a.** Unclamped Inductive Test Circuit



**Fig 18b.** Unclamped Inductive Waveforms

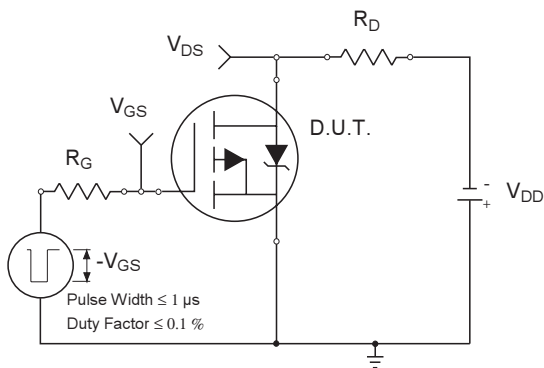

**Fig 19a.** Switching Time Test Circuit

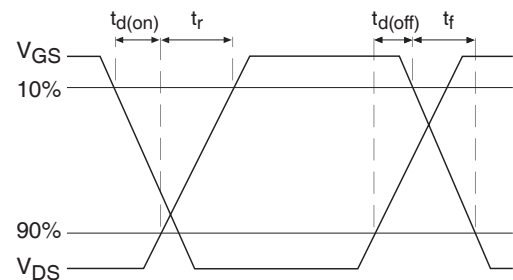

**Fig 19b.** Switching Time Waveforms

## SO-8 Package Outline (MOSFET & Fetky)

Dimensions are shown in millimeters (inches)

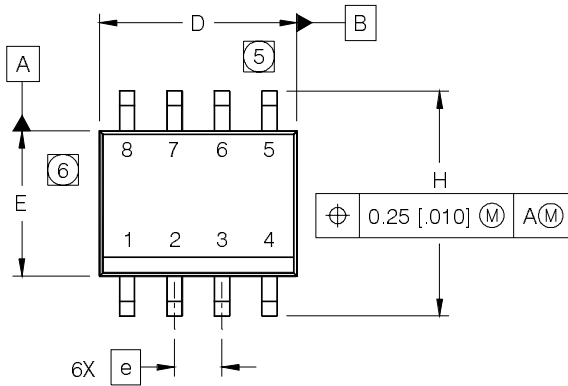

DIM	INCHES		MILLIMETERS	
	MIN	MAX	MIN	MAX
A	.0532	.0688	1.35	1.75
A1	.0040	.0098	0.10	0.25
b	.013	.020	0.33	0.51
c	.0075	.0098	0.19	0.25
D	.189	.1968	4.80	5.00
E	.1497	.1574	3.80	4.00
e	.050 BASIC		1.27 BASIC	
e 1	.025 BASIC		0.635 BASIC	
H	.2284	.2440	5.80	6.20
K	.0099	.0196	0.25	0.50
L	.016	.050	0.40	1.27
y	0°	8°	0°	8°

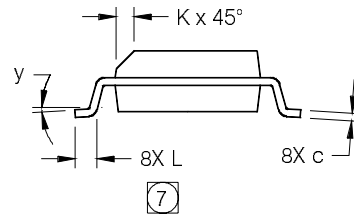
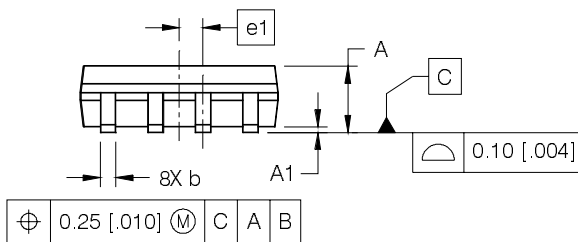

### FOOTPRINT

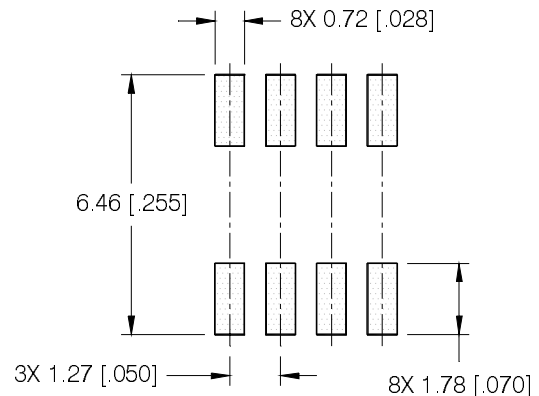

### NOTES:

1. DIMENSIONING & TOLERANCING PER ASME Y14.5M-1994.
2. CONTROLLING DIMENSION: MILLIMETER
3. DIMENSIONS ARE SHOWN IN MILLIMETERS [INCHES].
4. OUTLINE CONFORMS TO JEDEC OUTLINE MS-012AA.
5. DIMENSION DOES NOT INCLUDE MOLD PROTRUSIONS. MOLD PROTRUSIONS NOT TO EXCEED 0.15 [0.006].
6. DIMENSION DOES NOT INCLUDE MOLD PROTRUSIONS. MOLD PROTRUSIONS NOT TO EXCEED 0.25 [0.010].
7. DIMENSION IS THE LENGTH OF LEAD FOR SOLDERING TO A SUBSTRATE.

## SO-8 Part Marking Information

EXAMPLE: THIS IS AN IRF7101 (MOSFET)

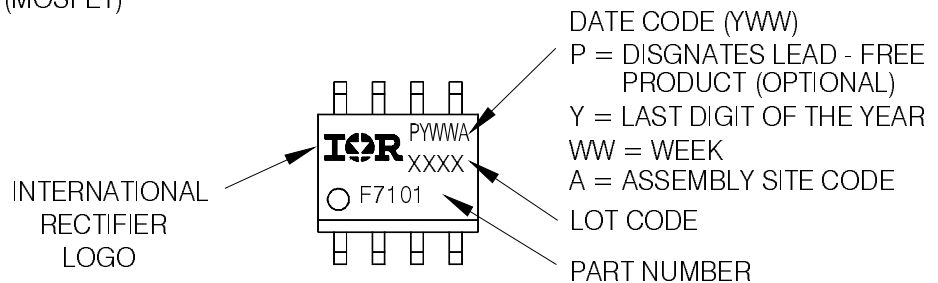

Note: For the most current drawing please refer to IR website at <http://www.irf.com/package/>

# IRF9321PbF

SO-8 Tape and Reel (Dimensions are shown in millimeters (inches))

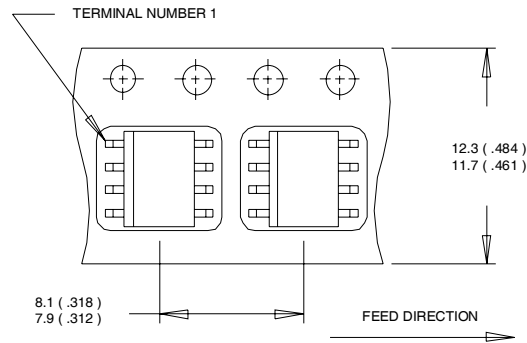

- NOTES:
1. CONTROLLING DIMENSION : MILLIMETER.
  2. ALL DIMENSIONS ARE SHOWN IN MILLIMETERS(INCHES).
  3. OUTLINE CONFORMS TO EIA-481 & EIA-541.

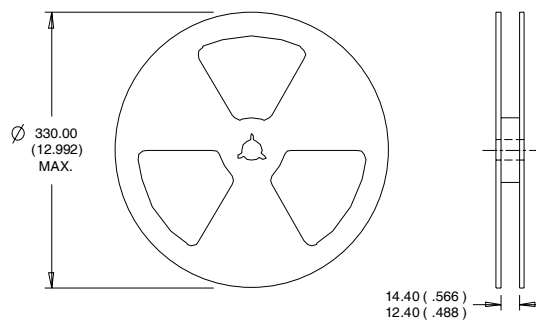

- NOTES :
1. CONTROLLING DIMENSION : MILLIMETER.
  2. OUTLINE CONFORMS TO EIA-481 & EIA-541.

## Qualification Information†

Qualification level	Consumer ††	
	(per JEDEC JESD47F††† guidelines)	
Moisture Sensitivity Level	SO-8	MSL1 (per JEDEC J-STD-020D†††)
RoHS Compliant	Yes	

† Qualification standards can be found at International Rectifier's web site  
<http://www.irf.com/product-info/reliability>

†† Higher qualification ratings may be available should the user have such requirements.  
Please contact your International Rectifier sales representative for further information:  
<http://www.irf.com/whoto-call/salesrep/>

††† Applicable version of JEDEC standard at the time of product release.

Data and specifications subject to change without notice.



# Mouser Electronics

Authorized Distributor

Click to View Pricing, Inventory, Delivery & Lifecycle Information:

[Infineon:](#)

[IRF9321TRPBF](#) [IRF9321PBF](#)