

SERIES: ETSA 100W U | **DESCRIPTION:** AC-DC POWER SUPPLY

FEATURES

- 100 W power
- universal input (90~264 Vac)
- single regulated outputs
- over voltage, over current, and short circuit protections
- UL/cUL safety approvals
- level V efficiency
- power factor correction
- custom designs available



MODEL	output voltage	output current max	output power max	ripple and noise ¹ max	efficiency level
	(Vdc)	(A)	(W)	(mVp-p)	
ETSA120834U	12	8.34	100	240	V
ETSA160625U	16	6.25	100	320	V
ETSA190527U	19	5.27	100	380	V
ETSA240417U	24	4.17	100	480	V
ETSA360278U	36	2.78	100	480	V
ETSA480209U	48	2.09	100	480	V

Notes: 1. Ripple and noise measured with 20 MHz bandwidth oscilloscope, each output terminated with 10 μ F/50 V electrolytic and 0.1 μ F ceramic capacitors.

PART NUMBER KEY

ETSA120834UX - P51 - WP - CXX

Base Number
example of 12 Vdc, 8.34 A

Input Cable:
 "Blank" = No Cable
 C = North American input cable
 2 = European input cable
 3 = United Kingdom input cable
 4 = Australian input cable
 5 = China input cable
 6 = South Korea input cable
 7 = Brazil input cable
 8 = South Africa input cable
 9 = Japan input cable

DC Plug Type

Factory Designation

Reserved for Custom Configurations

INPUT

parameter	conditions/description	min	typ	max	units
voltage		90		264	Vac
frequency		47		63	Hz
current	at 90 Vac, 50 Hz			2.5	A
inrush current	at 230 Vac, cold start			150	A
power factor correction	at full load		0.9		
no load power consumption				0.5	W

OUTPUT

parameter	conditions/description	min	typ	max	units
total regulation		-2		+5	%
hold-up	at 115/230 Vac, 50/60 Hz, full load	16			ms
temperature coefficient				±0.05	%/°C

PROTECTIONS

parameter	conditions/description	min	typ	max	units
over voltage protection	auto latch off	110		130	%
over current protection	auto restart when overload is removed	110		160	%
short circuit protection	auto shutdown, auto restart when short circuit removed				

SAFETY & COMPLIANCE

parameter	conditions/description	min	typ	max	units
isolation voltage	input to output for 4 seconds	4,242			Vdc
	input to ground for 4 seconds	2,121			Vdc
isolation resistance	input to output at 500 Vdc	20			MΩ
	input to ground at 500 Vdc	20			MΩ
safety approvals	UL/cUL, GS				
EMI/EMC	FCC Part 15 Class B, EN55022/EN55024 Class B, CE				
MTBF	at full load, 25°C	140,000			hrs
RoHS	2011/65/EU				

ENVIRONMENTAL

parameter	conditions/description	min	typ	max	units
operating temperature	derate linearly 2.5% per °C from 41~60°C	0		60	°C
storage temperature	12 Vdc & 16 Vdc output models	-10		85	°C
	all other models	-10		70	°C
operating humidity	non-condensing	20		90	%
storage humidity	non-condensing	20		90	%

MECHANICAL

parameter	conditions/description	min	typ	max	units
dimensions	170 x 85 x 44				mm
input plug	IEC320 / C14				

MECHANICAL DRAWING

units: mm
tolerance: ± 0.5 mm

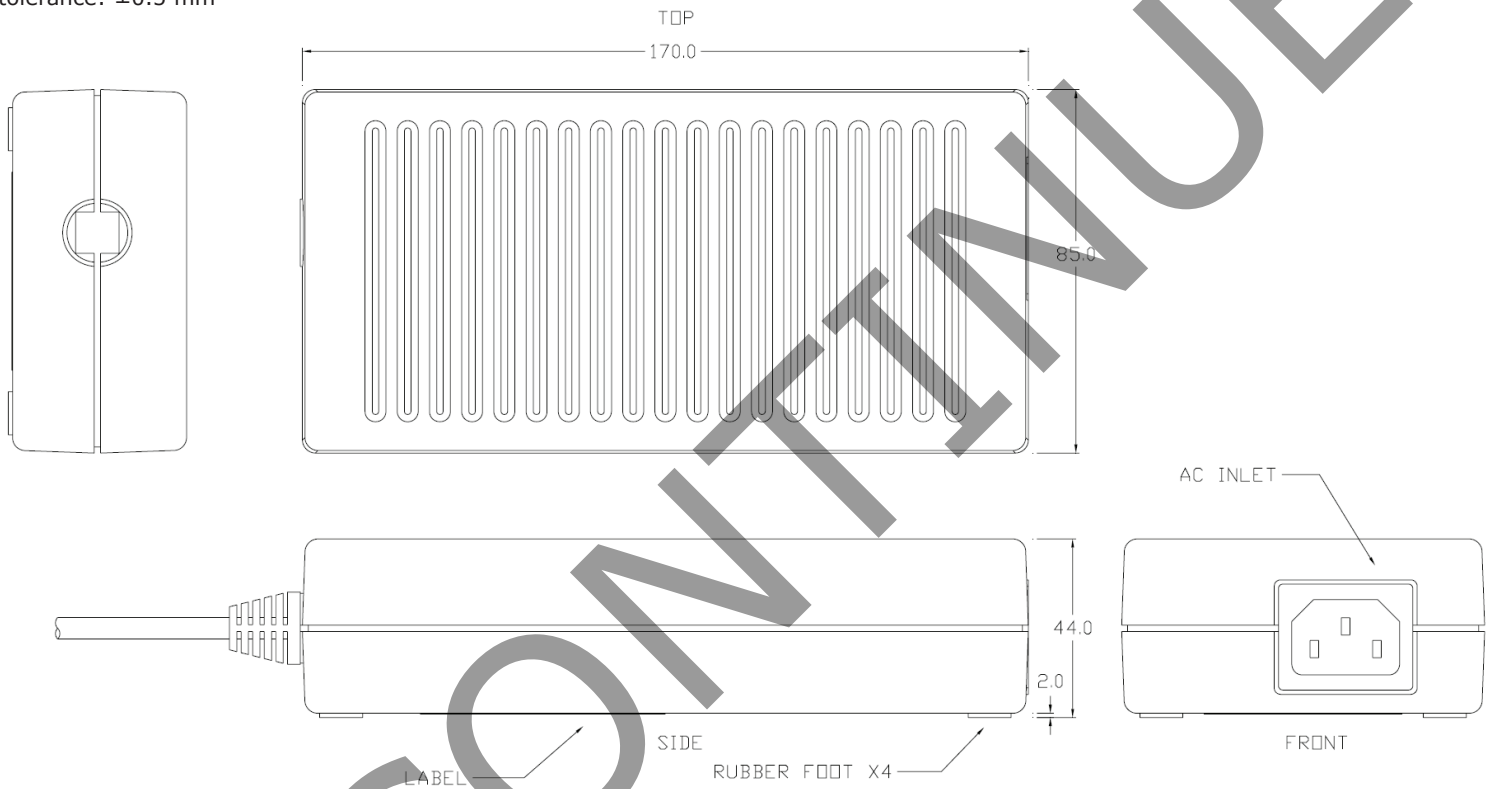

DC CORD

units: mm

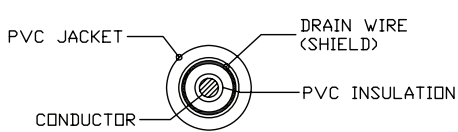

See Table 1
SECTIONAL DRAWING

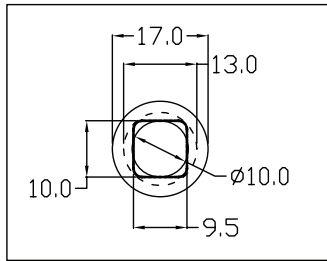
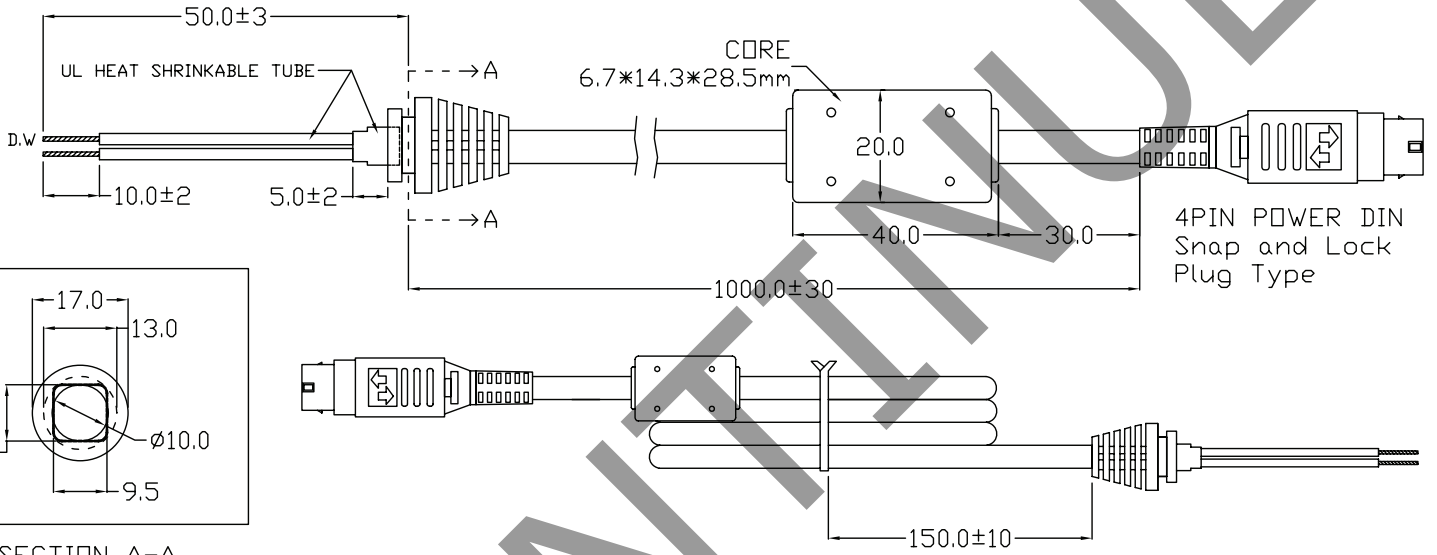
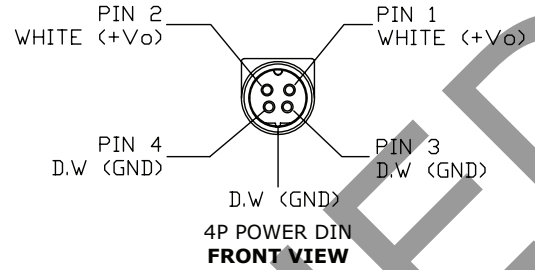

SECTION A-A

Table 1

MODEL NO.	CABLE
ETSA120834U	14 AWG, Black, UL1571, 80°C, 30 V, 14 AWGX1C + aluminum shield (14 AWG)
ETSA160625U	14 AWG, Black, UL1571, 80°C, 30 V, 14 AWGX1C + aluminum shield (14 AWG)
ETSA190527U	14 AWG, Black, UL1571, 80°C, 30 V, 14 AWGX1C + aluminum shield (14 AWG)
ETSA240417U	14 AWG, Black, UL1571, 80°C, 30 V, 14 AWGX1C + aluminum shield (14 AWG)
ETSA360278U	16 AWG, Black, UL1185 80/90°C, 300 V, 16 AWGX1C + aluminum shield (16 AWG)
ETSA480209U	16 AWG, Black, UL1185 80/90°C, 300 V, 16 AWGX1C + aluminum shield (16 AWG)

AC CORD

NORTH AMERICAN INPUT CABLE

units: mm

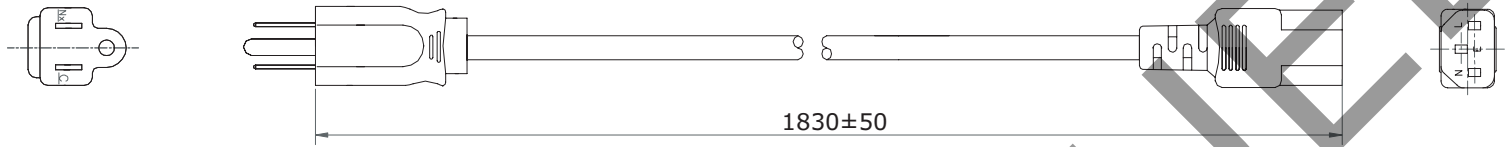

EUROPEAN INPUT CABLE

units: mm

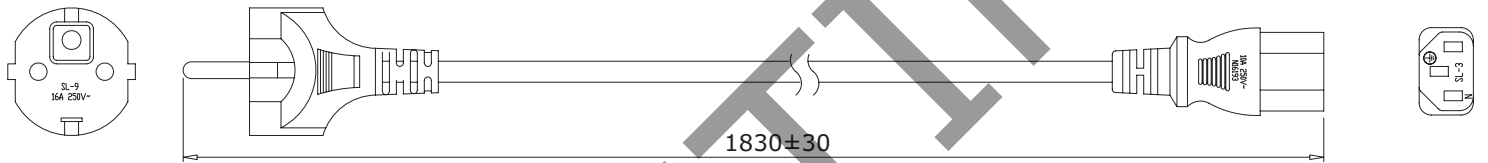

UNITED KINGDOM INPUT CABLE

units: mm

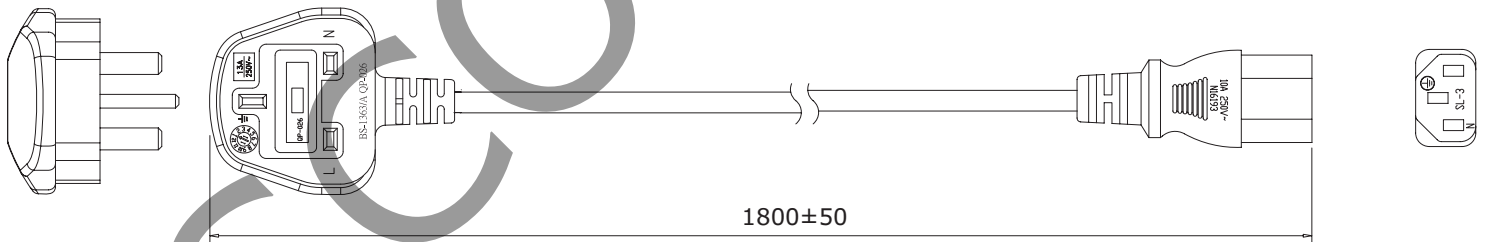

AUSTRALIAN INPUT CABLE

units: mm

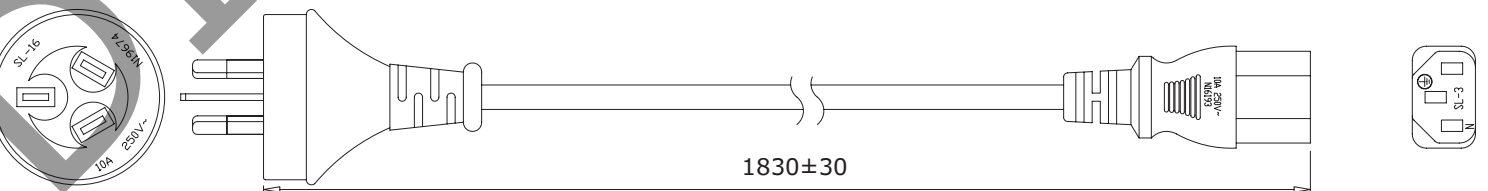

AC CORD (CONTINUED)

CHINA INPUT CABLE

units: mm

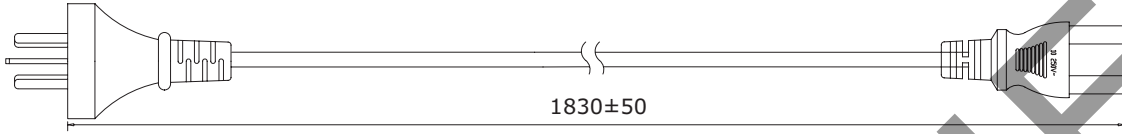

SOUTH KOREA INPUT CABLE

units: mm

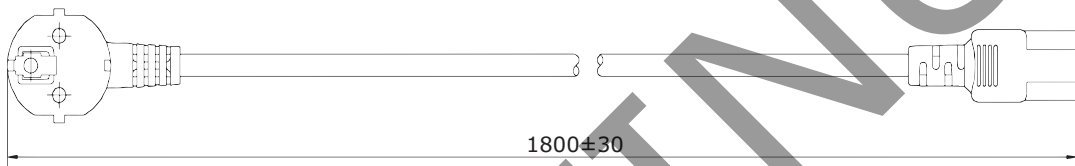
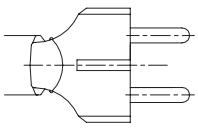

BRAZIL INPUT CABLE

units: mm

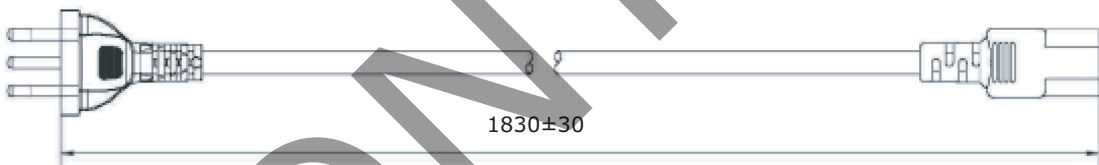
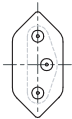

SOUTH AFRICA INPUT CABLE

units: mm

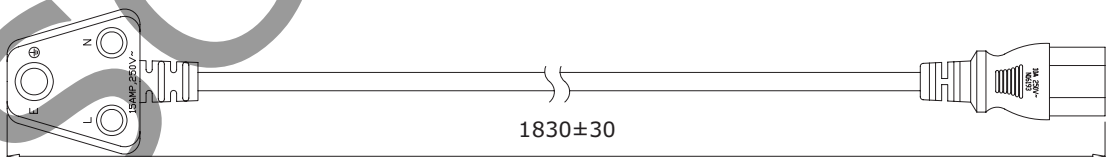
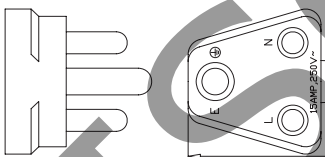

JAPAN INPUT CABLE

units: mm

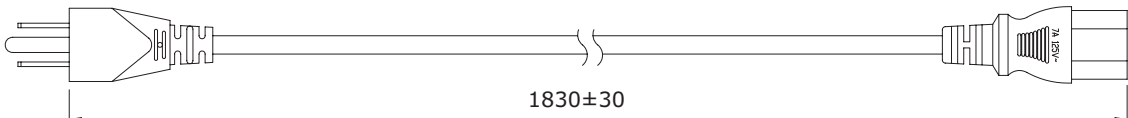

REVISION HISTORY

rev.	description	date
1.0	initial release	11/22/2013
1.01	added ac cord options	10/09/2014

The revision history provided is for informational purposes only and is believed to be accurate.

This device complies with part 15 of the FCC Rules. Operation is subject to the following two conditions:

- (1) This device may not cause harmful interference, and
- (2) this device must accept any interference received, including interference that may cause undesired operation.

CUI offers a one (1) year limited warranty. Complete warranty information is listed on our website.

CUI reserves the right to make changes to the product at any time without notice. Information provided by CUI is believed to be accurate and reliable. However, no responsibility is assumed by CUI for its use, nor for any infringements of patents or other rights of third parties which may result from its use.

CUI products are not authorized or warranted for use as critical components in equipment that requires an extremely high level of reliability. A critical component is any component of a life support device or system whose failure to perform can be reasonably expected to cause the failure of the life support device or system, or to affect its safety or effectiveness.



CUI INC[®]

Headquarters
20050 SW 112th Ave.
Tualatin, OR 97062
800.275.4899

Fax 503.612.2383
cui.com
techsupport@cui.com