



## CENTIGRID® COMMERCIAL RELAYS DPDT

SERIES	RELAY TYPE
172	DPDT basic relay
172D	DPDT relay with internal diode for coil transient suppression

### DESCRIPTION

The 172 Centigrd® relay is an ultraminiature, hermetically sealed, armature relay for commercial applications. Its low profile height (.280") and .100" grid spaced terminals, which preclude the need for spreader pads, make it an ideal choice where extreme packaging density and/or close PC board spacing are required.

The basic operating concept and internal structure are similar to Teledyne's DPDT 114 Centigrd® relay. Unique construction features and manufacturing techniques provide overall high reliability and excellent resistance to environmental extremes:

#### The 172 feature:

- All welded construction.
- Unique uni-frame design providing high magnetic efficiency and mechanical rigidity.

- High force/mass ratios for resistance to shock and vibration.
- Advanced cleaning techniques provide maximum assurance of internal cleanliness.
- Precious metal alloy contact material with gold plating assures excellent high current and dry circuit switching capabilities.

The Series 172 relay has an internal discrete silicon diode for coil transient suppression.

By virtue of its inherently low intercontact capacitance and contact circuit losses, the 172 relay is an excellent subminiature RF switch for frequencies well into the UHF spectrum (see Figure 1). Applications include telecommunications, test instruments, mobile communications, attenuators, and automatic test equipment.

### Part Numbering System

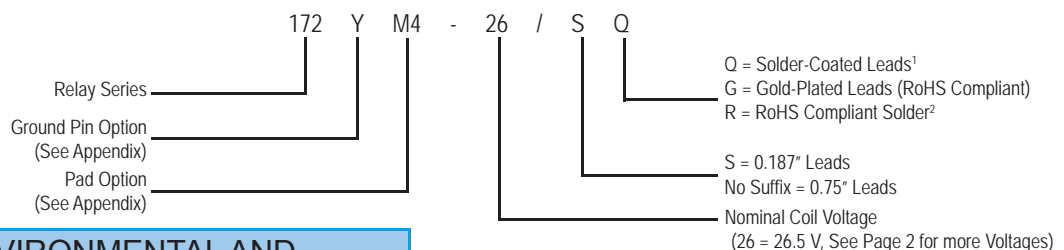

### ENVIRONMENTAL AND PHYSICAL SPECIFICATIONS

<b>Temperature</b> (Operating)	-55°C to +85°C
<b>Vibration</b> (General Note I)	10 g's to 500 Hz
<b>Shock</b> (General Note I)	30 g's, 6ms half sine
<b>Enclosure</b>	Hermetically sealed
<b>Weight</b>	0.15 oz. (4.3g) max.

### INTERNAL CONSTRUCTION

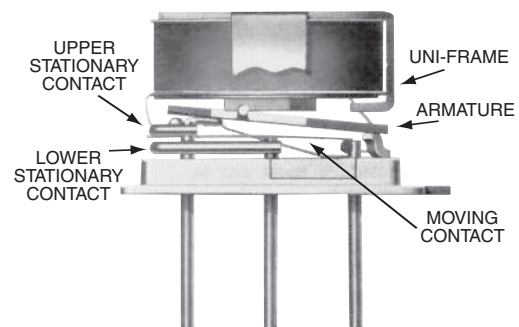

**SERIES 172**  
**GENERAL ELECTRICAL SPECIFICATIONS (@25°C)**

<b>Contact Arrangement</b>	2 Form C (DPDT)	
<b>Rated Duty</b>	Continuous	
<b>Contact Resistance</b>	0.15 Ω max.	
<b>Contact Load Rating</b>	Resistive: 1 A / 28 Vdc Inductive: 200 mA / 28 Vdc (320mH) Lamp: 100 mA / 28 Vdc (320mH) Low level: 10 to 50 μA @ 10 to 50 mV	
<b>Contact Life Ratings</b>	5,000,000 cycles (typical) at low level 500,000 cycles (typical) at 0.5 A / 28 Vdc resistive 100,000 cycles min. at all other loads specified above	
<b>Contact Overload Rating</b>	2 A / 28 Vdc Resistive (100 cycles min.)	
<b>Contact Carry Rating</b>	Contact Factory	
<b>Operate Time</b>	6.0 msec max. at nominal rated coil voltage	
<b>Release Time</b>	172: 3.0 ms max.	172D: 6.0 ms max.
<b>Intercontact Capacitance</b>	0.4 pf typical	
<b>Insulation Resistance</b>	1,000 MΩ min. between mutually isolated terminals	
<b>Dielectric Strength</b>	300 Vrms (60 Hz) @ atmospheric pressure	
<b>Negative Coil Transient (Vdc)</b>	2.0 Vdc Max.	
<b>Diode P.I.V. (Vdc)</b>	60 Vdc Min.	

**DETAILED ELECTRICAL SPECIFICATIONS (@25°C)**

BASE PART NUMBERS (172, 172D)		172-3	172-5	172-12	172-26
		172D-3	172D-5	172D-12	172D-26
<b>Coil Voltage</b>	<b>Nom.</b>	3.0	5.0	12.0	26.5
	<b>Max.</b>	3.6	5.8	16.0	32.0
<b>Coil Resistance (Ohms ±20%)</b>		39	64	400	1600
<b>Pick-up Voltage (Vdc, Max.) Pulse Operation</b>		2.25	3.8	9.0	18.0
<b>Coil Operating Power at Nominal Voltage (mW)</b>		235	405	360	440

**PERFORMANCE CURVES (Note 2)**

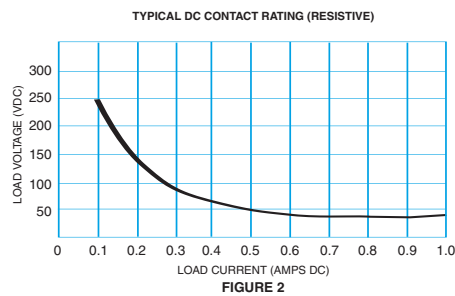
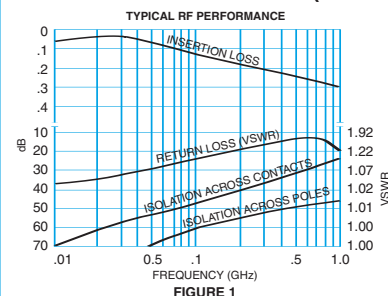

**GENERAL NOTES**

1. Relay contacts will exhibit no chatter in excess of 10 μsec or transfer in excess of 1 μsec.
2. "Typical" characteristics are based on available data and are best estimates. No on-going verification tests are performed.
3. Unless otherwise specified, parameters are initial values.
4. Relays can be supplied with a spacer pad. See appendix.

**SERIES 172  
OUTLINE DIMENSIONS**

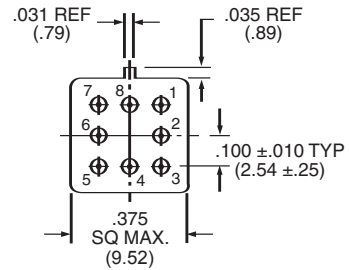
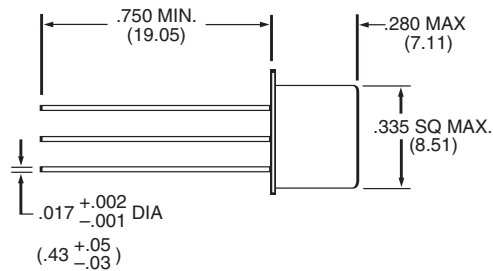

(Viewed From Terminals)

**SCHEMATIC DIAGRAMS**

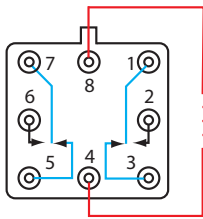

172

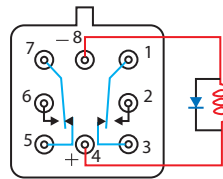

172D

**NOTES:**

1. RELAY CONTACTS WILL EXHIBIT NO CHATTER IN EXCESS OF 10 MSEC OR TRANSFER IN EXCESS OF 1 MSEC.
2. "TYPICAL" CHARACTERISTICS ARE BASED ON AVAILABLE DATA AND ARE BEST ESTIMATES. NO ON-GOING VERIFICATION TESTS ARE PERFORMED.
3. UNLESS OTHERWISE SPECIFIED, PARAMETERS ARE INITIAL VALUES.
4. RELAYS CAN BE SUPPLIED WITH A SPACER PAD. SEE APPENDIX.

## APPENDIX: Spacer Pads

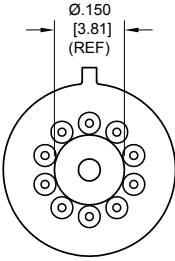
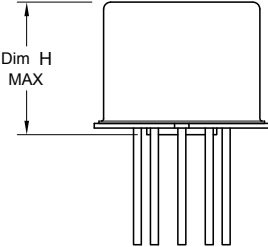
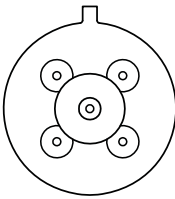
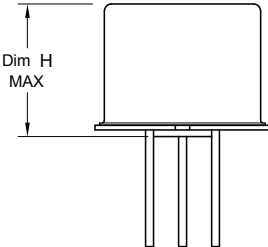
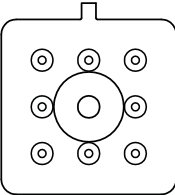
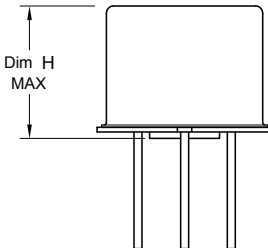
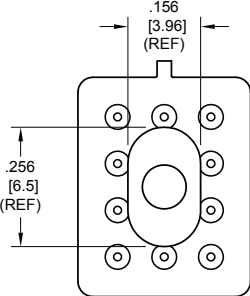
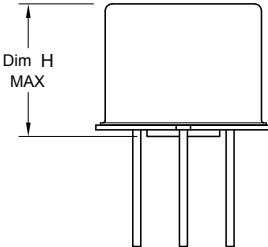
Pad designation and bottom view dimensions	Height	For use with the following:	Dim. H Max.
 <p style="text-align: center;">“M4” Pad for TO-5</p>		ER412, ER412D, ER412DD	.295 (7.49)
		712, 712D, 712TN, RF300, RF310, RF320 RF700, RF703	.300 (7.62)
		ER420, ER420D, ER420DD, 421, ER421D, ER421DD, ER422, ER422D, ER422DD, 722, 722D, RF341	.305 (7.75)
		ER431T, ER432T, ER432, ER432D, ER432DD	.400 (10.16)
		732, 732D, 732TN, RF303, RF313, RF323	.410 (10.41)
		RF312, RF332 SI800, SI803	.350 (8.89)
 <p style="text-align: center;">“M4” Pad for TO-5</p>		ER411, ER411D, ER411DD, ER411T	.295 (7.49)
		ER431, ER431D, ER431DD	.400 (10.16)
		RF311	.300 (7.62)
		RF331	.410 (10.41)
 <p style="text-align: center;">“M4” Pad for Centigrid®</p>		172, 172D	.305 (7.75)
		ER114, ER114D, ER114DD, J114, J114D, J114DD	.300 (7.62)
		ER134, ER134D, ER134DD, J134, J134D, J134DD	.400 (10.16)
		RF100	.315 (8.00)
		RF103	.420 (10.67)
 <p style="text-align: center;">“M9” Pad for Centigrid®</p>		122C, A152	.320 (8.13)
		ER116C, J116C	.300 (7.62)
		ER136C, J136C	.400 (10.16)
		RF180	.325 (8.25)
		A150	.305 (7.75)

**Notes:**

1. Spacer pad material: Polyester film.
2. To specify an “M4” or “M9” spacer pad, refer to the mounting variants portion of the part numbering example in the applicable datasheet.
3. Dimensions are in inches (mm).
4. Unless otherwise specified, tolerance is  $\pm .010$ " (.25 mm).
5. Add 10 m $\Omega$  to the contact resistance shown in the datasheet.
6. Add 0.01 oz. (0.25 g) to the weight of the relay assembly shown in the datasheet.

## APPENDIX: Spreader Pads

Pad designation and bottom view dimensions	Height	For use with the following:	Dim. H Max.
<p style="text-align: center;"><b>"M" Pad <u>5/ 6/</u></b></p>		ER411T, J411T, ER412, ER412D ER412DD, J412, J412D, J412DD ER412T, J412T	.388 (9.86)
		712, 712D, 712TN	.393 (9.99)
		ER431T, J431T, ER432, ER432D ER432DD, J432, J432D, J432DD ER432T, J432T	.493 (12.52)
		732, 732D, 732TN	.503 (12.78)
		ER420, J420, ER420D, J420D ER420DD, J420DD, ER421, J421 ER421D, J421D, ER421DD J422D, ER422DD, J422DD, 722	.398 (10.11)
<p style="text-align: center;"><b>"M2" Pad <u>7/ 8/</u></b></p>		ER411T ER412, ER412D, ER412DD J412, J412D, J412DD	.441 (11.20)
		712, 712D	.451 (11.46)
		ER421, ER421D, ER421DD 722, 732D	.451 (11.46)
		ER431T ER432, ER432D, ER432DD	.546 (13.87)
<p style="text-align: center;"><b>"M3" Pad <u>5/ 6/ 9/</u></b></p>		ER411, ER411D, ER411DD, ER411TX ER412X, ER412DX, ER412DDX ER412TX	.388 (9.86)
		712X, 712DX, 712TNX	.393 (9.99)
		ER420X, ER420DX, ER420DDX ER421X, ER421DX, ER421DDX ER422X, ER422DX ER422DDX, 722X, 722DDX	.398 (10.11)
		ER431, ER431D, ER431DD ER431TX ER432X, ER432DX, ER432DDX ER432TX	.493 (12.52)
		732X, 732DX, 732TNX	.503 (12.78)

**Notes:**

1. Spreader pad material: Diallyl Phthalate.
2. To specify an "M", "M2" or "M3" spreader pad, refer to the mounting variants portion of the part number example in the applicable datasheet.
3. Dimensions are in inches (mm).
4. Unless otherwise specified, tolerance is  $\pm .010$ " (0.25 mm).
- 5/. Add 25 m $\Omega$  to the contact resistance shown in the datasheet.
- 6/. Add .01 oz. (0.25 g) to the weight of the relay assembly shown in the datasheet.
- 7/. Add 50 m $\Omega$  to the contact resistance shown in the datasheet.
- 8/. Add 0.025 oz (0.71 g) to the weight of the relay assembly shown in the datasheet.
- 9/. M3 pad to be used only when the relay has a center pin (e.g. ER411M3-12A, 722XM3-26.)

## APPENDIX: Ground Pin Positions

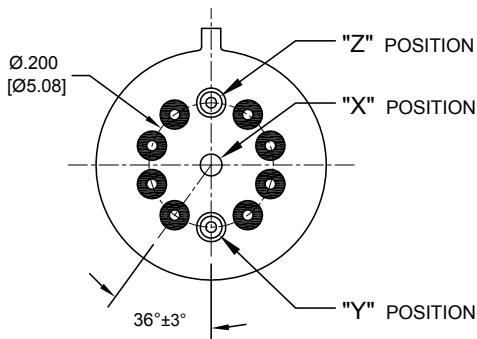

**TO-5 Relays:**

ER411T, ER412, ER412T, ER420, ER421, ER422, ER431T, ER432, ER432T, 712, 712TN, 400H, 400K, 400V, RF300, RF303, RF341, RF312, RF332, RF310, RF313, RF320, RF323, SI800, SI803, RF700, RF703

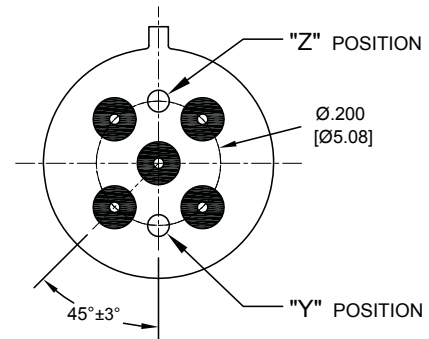

**TO-5 Relays:**

ER411, ER431, RF311, RF331

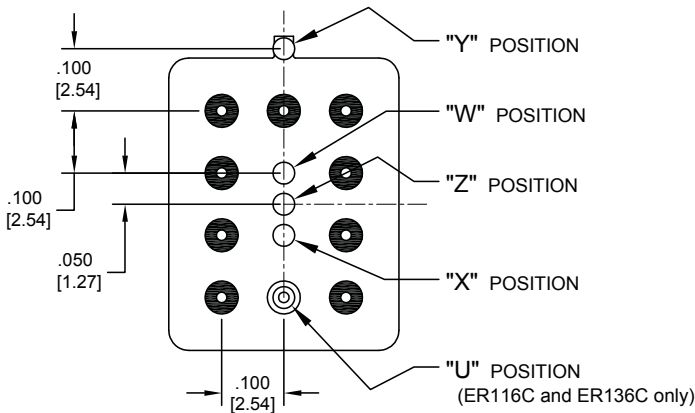

**Centigrid® Relays:**

RF180, ER116C, 122C, ER136C

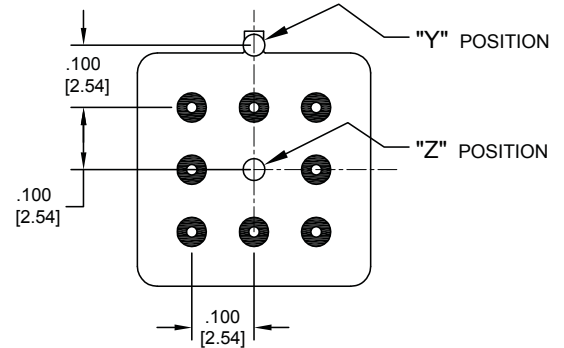

**Centigrid® Relays:**

RF100, RF103, ER114, ER134, 172

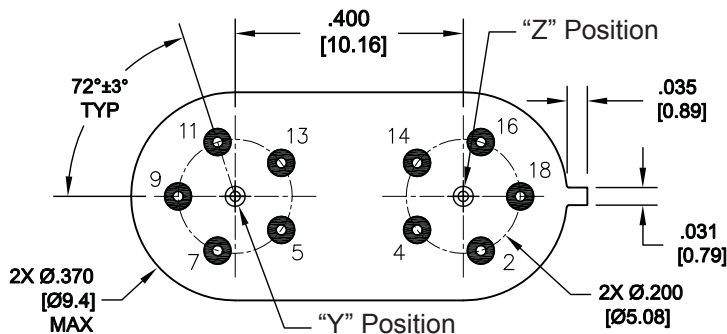

**Loopback Relays:**

LB363

**NOTES**

- Indicates ground pin position
- Indicates glass insulated lead position
- ◎ Indicates ground pin or lead position depending on relay type

1. Terminal views shown
2. Dimensions are in inches (mm)
3. Tolerances: ± .010 (±.25) unless otherwise specified
4. Ground pin positions are within .015 (0.38) dia. of true position
5. Ground pin head dia., 0.035 (0.89) ref: height 0.010 (0.25) ref.
6. Lead dia. 0.017 (0.43) nom.

# Mouser Electronics

Authorized Distributor

Click to View Pricing, Inventory, Delivery & Lifecycle Information:

## Teledyne Relays:

[172-12](#) [172-26](#) [172-5](#) [172D-12](#) [172D-26](#) [172D-5](#) [172DM4-12](#) [172DM4-26](#) [172M4-5](#) [400-192-10](#) [400-192-59](#)  
[172-12/G](#)