

## Ultrafast recovery diode high efficiency

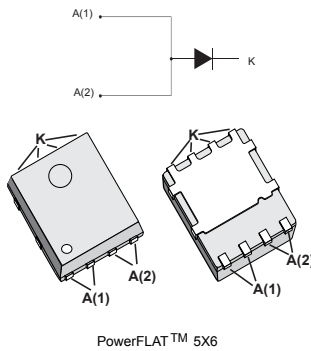

### Features

- Suited for DC/DC converts
- Low losses
- High  $T_j$
- High surge current capability
- High energy avalanche capability
- 1 mm package thickness
- ECOPACK®2 compliant component

### Description

High performance diode suited for high frequency DC to DC converters.

Packaged in PowerFLAT™ 5x6, this device is intended to be used in low voltage high frequency inverters.

PowerFLAT is a trademark of STMicroelectronics.

Product status	
STTH5R06DJF	
Product summary	
$I_{F(AV)}$	5 A
$V_{RRM}$	600 V
$T_j(max.)$	175 °C
$V_F(typ.)$	0.95 V
$t_{rr}(typ.)$	30 ns

# 1 Characteristics

**Table 1. Absolute ratings (limiting values at 25 °C, unless otherwise specified, anode terminals short circuited)**

Symbol	Parameter	Value	Unit	
$V_{RRM}$	Repetitive peak reverse voltage	600	V	
$I_{F(RMS)}$	Forward rms current	45	A	
$I_{F(AV)}$	Average forward current	$T_C = 160\text{ °C}, \delta = 0.5, \text{ square wave}$	5	A
$I_{FSM}$	Surge non repetitive forward current	$t_p = 10\text{ ms sinusoidal}$	190	A
$T_{stg}$	Storage temperature range	-65 to +175	°C	
$T_j$	Maximum operating junction temperature	175	°C	

**Table 2. Thermal parameters**

Symbol	Parameter	Max. value	Unit
$R_{th(j-c)}$	Junction to case	2.0	°C/W

**Table 3. Static electrical characteristics (anode terminals short circuited)**

Symbol	Parameter	Test conditions	Min.	Typ.	Max.	Unit
$I_R^{(1)}$	Reverse leakage current	$T_j = 25\text{ °C}$	-	60	60	$\mu\text{A}$
		$T_j = 125\text{ °C}$				
$V_F^{(2)}$	Forward voltage drop	$T_j = 25\text{ °C}$	-	1.55	2.00	V
		$T_j = 125\text{ °C}$		0.95	1.20	

1. Pulse test:  $t_p = 5\text{ ms}, \delta < 2\%$

2. Pulse test:  $t_p = 380\text{ }\mu\text{s}, \delta < 2\%$

To evaluate the conduction losses use the following equation:

$$P = 0.9 \times I_{F(AV)} + 0.06 I_F^2 (RMS)$$

**Table 4. Recovery characteristics**

Symbol	Parameter	Test conditions	Min.	Typ.	Max.	Unit
$t_{rr}$	Reverse recovery time	$T_j = 25\text{ °C}$	-	30	40	ns
		$I_F = 1\text{ A}, V_R = 30\text{ V}, dI_F/dt = -100\text{ A}/\mu\text{s}$		40	55	
$I_{RM}$	Reverse recovery current	$T_j = 125\text{ °C}$	-	6.0	8.0	A
$S_{factor}$	Reverse recovery softness factor		$I_F = 5\text{ A}, V_R = 400\text{ V}, dI_F/dt = -200\text{ A}/\mu\text{s}$	-	0.5	-
$Q_{rr}$	Reverse recovery charges		-	180	nC	

**Table 5. Turn-on switching characteristics**

Symbol	Parameter	Test conditions		Min.	Typ.	Max.	Unit
$t_{fr}$	Forward recovery time	$T_j = 25\text{ °C}$	$I_F = 5\text{ A}$ , $V_{FR} = 1.6\text{ V}$ , $di_F/dt = -100\text{ A}/\mu\text{s}$	-		150	ns
$V_{FP}$	Forward recovery voltage			-	2.3	3.5	V

### 1.1 Characteristics (curves)

**Figure 1. Average forward power dissipation versus average forward current**

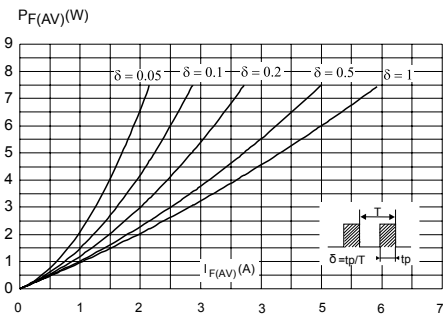

**Figure 2. Forward voltage drop versus forward current**

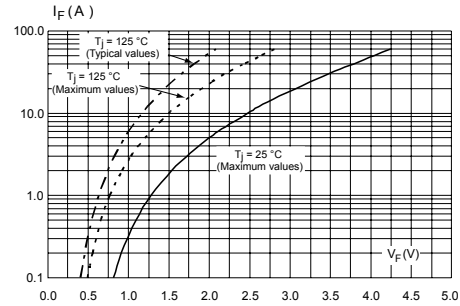

**Figure 3. Relative variation of thermal impedance junction to case versus pulse duration**

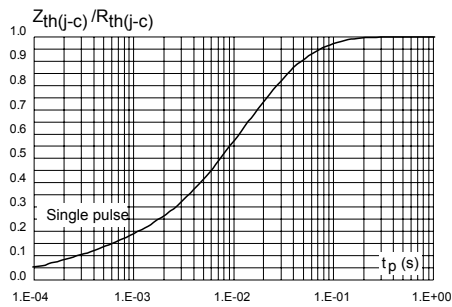

**Figure 4. Peak reverse recovery current versus  $di_F/dt$  (typical values)**

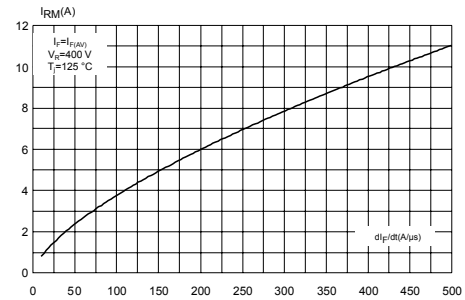

**Figure 5. Reverse recovery time versus  $di_F/dt$  (typical values)**

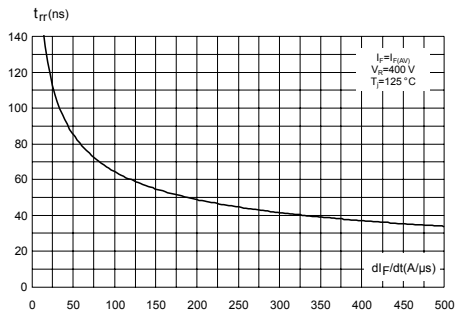

**Figure 6. Reverse recovery charges versus  $di_F/dt$  (typical values)**

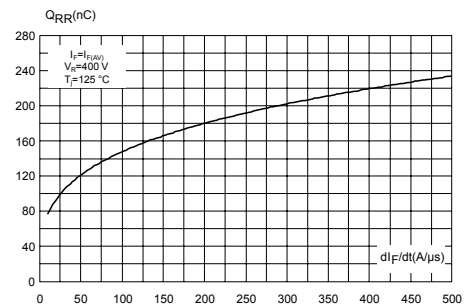

**Figure 7. Softness factor versus  $di_F/dt$  (typical values)**

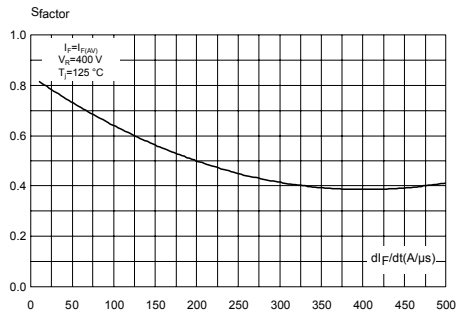

**Figure 8. Relative variations of dynamic parameters versus junction temperature**

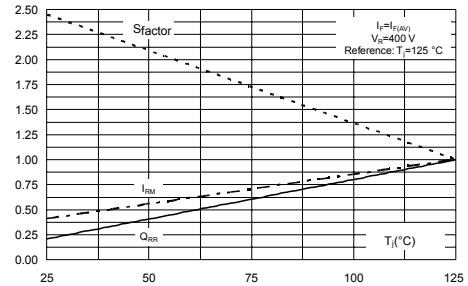

**Figure 9. Transient peak forward voltage versus  $di_F/dt$  (typical values)**

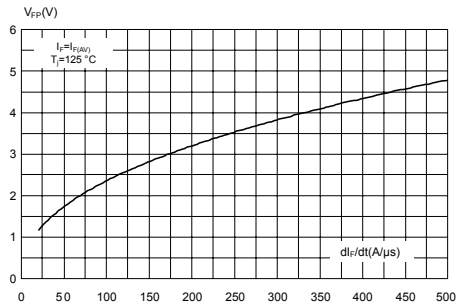

**Figure 10. Forward recovery time versus  $di_F/dt$  (typical values)**

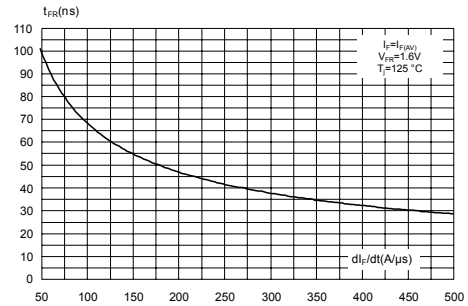

**Figure 11. Junction capacitance versus reverse voltage applied (typical values)**

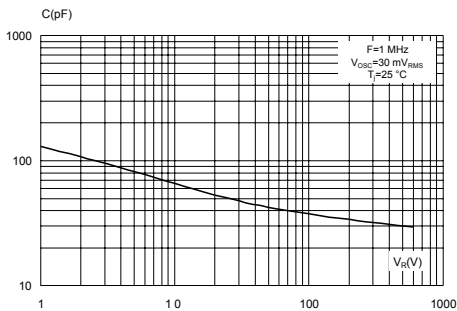

**Figure 12. Thermal resistance junction to ambient versus copper surface under tab**

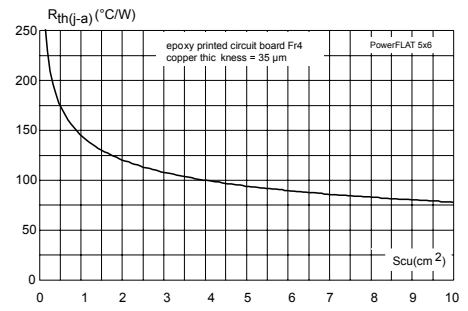

---

## 2 Package information

---

In order to meet environmental requirements, ST offers these devices in different grades of ECOPACK® packages, depending on their level of environmental compliance. ECOPACK® specifications, grade definitions and product status are available at: [www.st.com](http://www.st.com). ECOPACK® is an ST trademark.

### 2.1 PowerFLAT™ 5x6 package information

- Epoxy meets UL 94,V0
- Cooling method: by conduction (C)

Figure 13. PowerFLAT™ 5x6 package outline

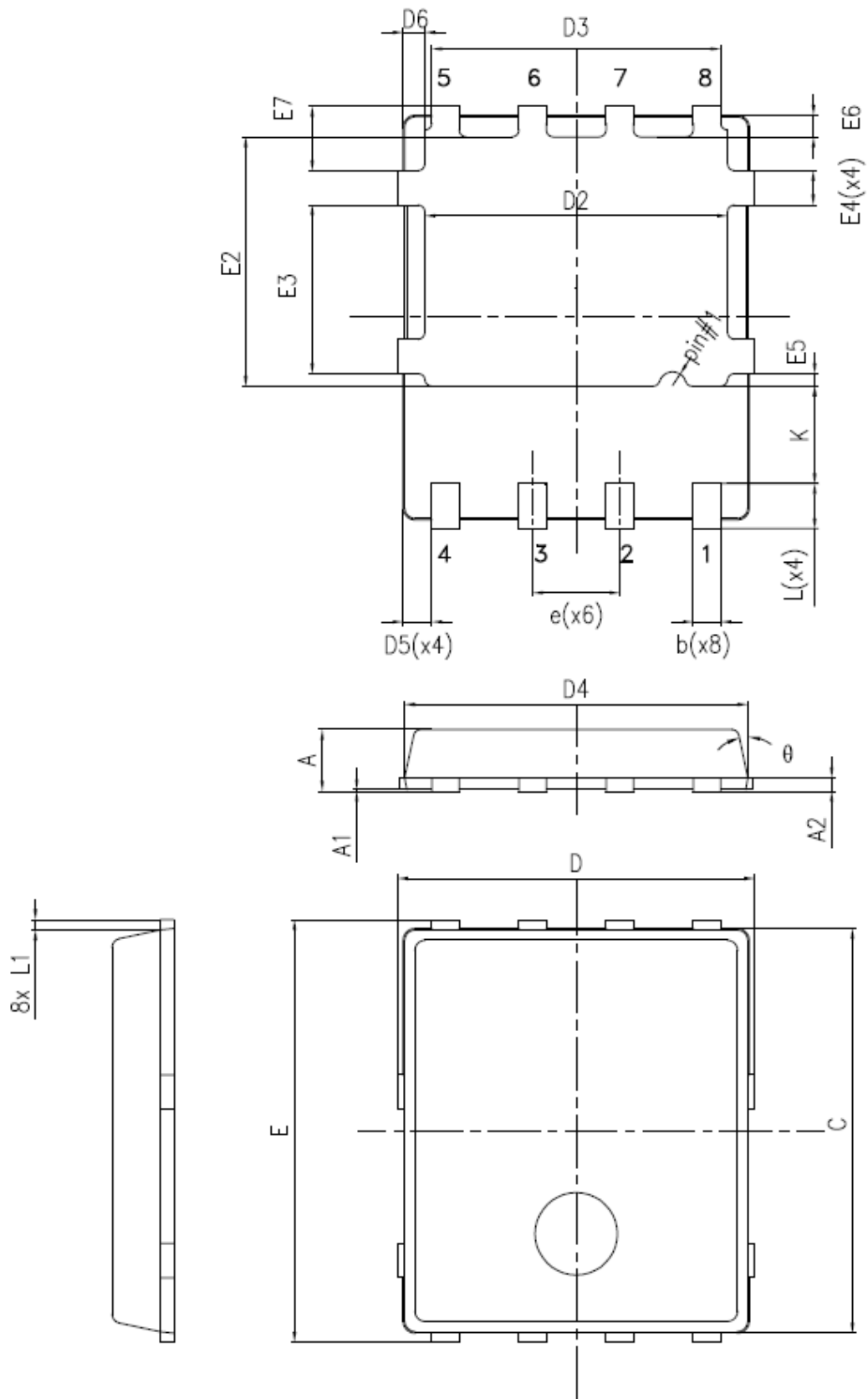

**Table 6. PowerFLAT™ 5x6 mechanical data**

Ref	Dim.					
	Millimeters			Inches		
	Min.	Typ.	Max.	Min.	Typ.	Max.
A	0.80		1.00	0.031		0.039
A1	0.02		0.05	0.001		0.002
A2		0.25			0.010	
b	0.30		0.50	0.012		0.020
C	5.80	6.00	6.20	0.228	0.236	0.244
D	5.00	5.20	5.40	0.196	0.205	0.212
D2	4.15		4.45	0.163		0.175
D3	4.05	4.20	4.35	0.159	0.165	0.171
D4	4.80	5.00	5.20	0.188	0.196	0.204
D5	0.25	0.40	0.55	0.009	0.015	0.021
D6	0.15	0.30	0.45	0.005	0.011	0.017
e		1.27			0.050	
E	5.95	6.15	6.35	0.234	0.242	0.250
E2	3.50		3.70	0.138		0.146
E3	2.35		2.55	0.092		0.100
E4	0.40		0.60	0.015		0.023
E5	0.08		0.28	0.003		0.011
E6	0.20	0.325	0.45	0.007	0.012	0.017
E7	0.75	0.90	1.05	0.029	0.035	0.041
K	1.275		1.575	0.050		0.062
L	0.60		0.80	0.023		0.031
L1	0.05	0.15	0.25	0.001	0.005	0.009
θ	0°		12°	0°		12°



Figure 14. PowerFLAT™ 5x6 recommended footprint (dimensions are in mm)

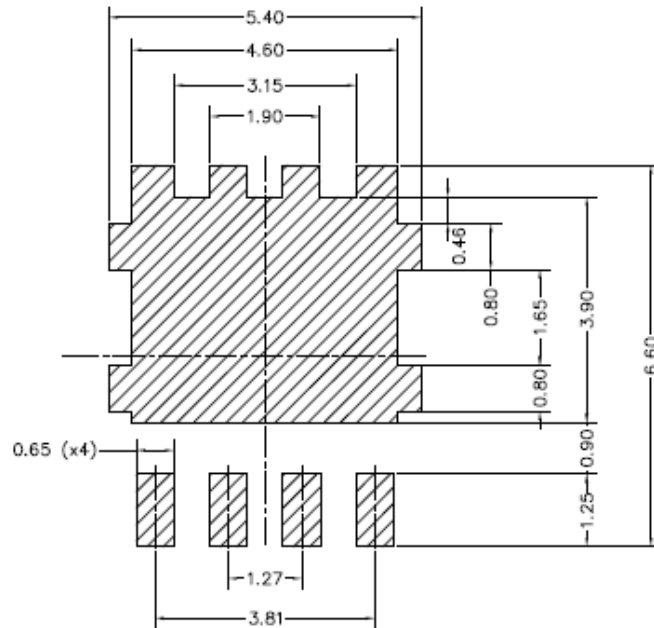
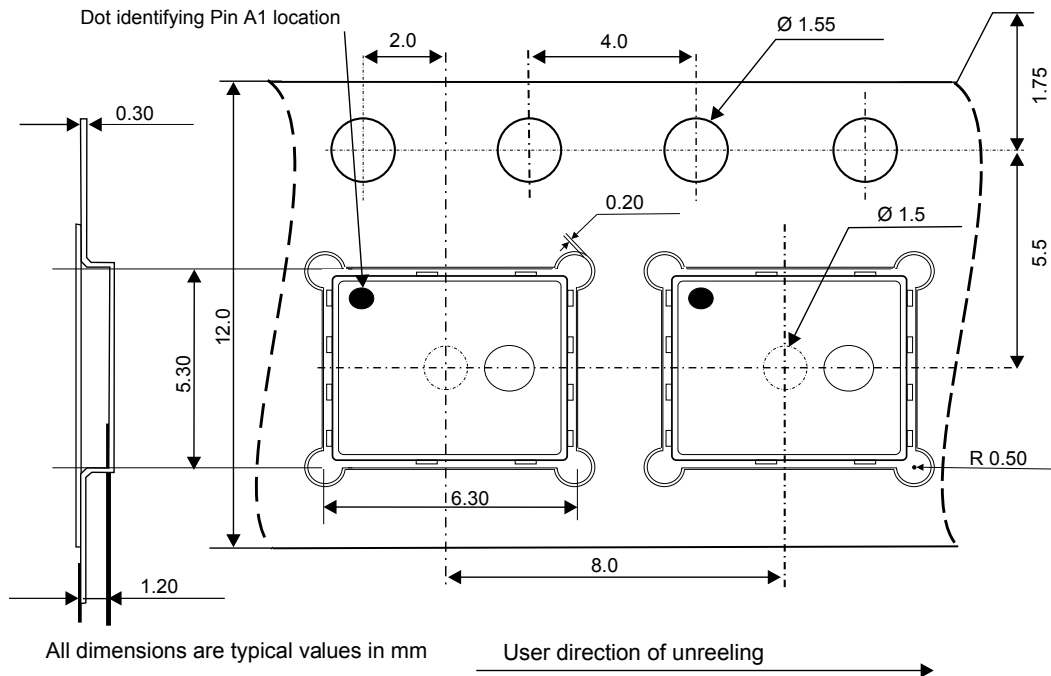

Figure 15. Tape and reel specifications



### 3 Ordering information

**Table 7. Ordering information**

Order code	Marking	Package	Weight	Base qty.	Delivery mode
STTH5R06DJF-TR	TH5R 06	PowerFLAT 5x6	0.095 g	3000	Tape and reel

## Revision history

**Table 8. Document revision history**

Date	Revision	Changes
16-Mar-2012	1	Initial release.
12-Mar-2018	2	Updated package outline information.

**IMPORTANT NOTICE – PLEASE READ CAREFULLY**

STMicroelectronics NV and its subsidiaries (“ST”) reserve the right to make changes, corrections, enhancements, modifications, and improvements to ST products and/or to this document at any time without notice. Purchasers should obtain the latest relevant information on ST products before placing orders. ST products are sold pursuant to ST’s terms and conditions of sale in place at the time of order acknowledgement.

Purchasers are solely responsible for the choice, selection, and use of ST products and ST assumes no liability for application assistance or the design of Purchasers’ products.

No license, express or implied, to any intellectual property right is granted by ST herein.

Resale of ST products with provisions different from the information set forth herein shall void any warranty granted by ST for such product.

ST and the ST logo are trademarks of ST. All other product or service names are the property of their respective owners.

Information in this document supersedes and replaces information previously supplied in any prior versions of this document.

© 2018 STMicroelectronics – All rights reserved

# Mouser Electronics

Authorized Distributor

Click to View Pricing, Inventory, Delivery & Lifecycle Information:

[STMicroelectronics:](#)

[STTH5R06DJF-TR](#)