

Description	Material	Finish
Body	Brass	Gold
Pin	Brass	Gold
Insulation	PTFE	N/A
Crimp Ring	Brass	Gold
Boyd Chuck	BE CU	Gold
Insulator	PTFE	N/A
Cover	Brass	Gold
Heat Shrink	Polyolefin	Black

REVISIONS			
REV	DESCRIPTION	DATE	APPV
B	Added new title block, heat shrink and instructions	12-JUL-12	SAH

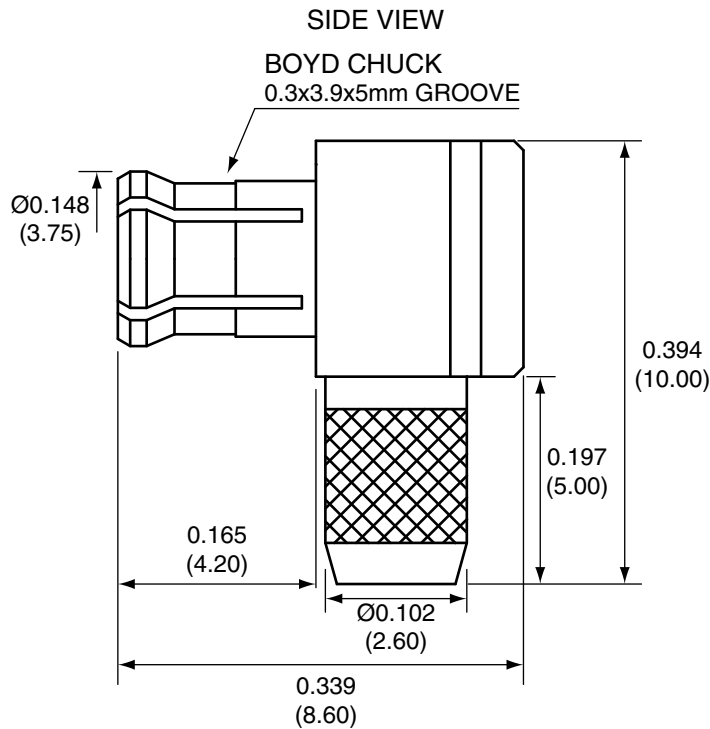
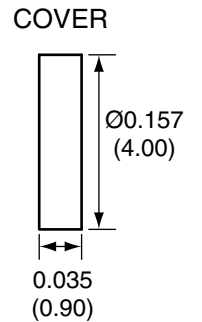
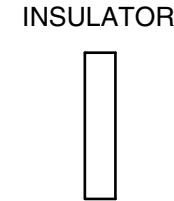
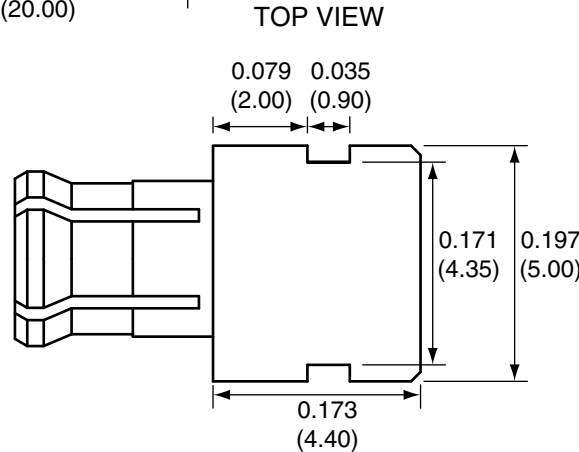
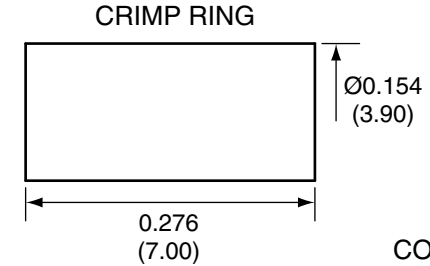
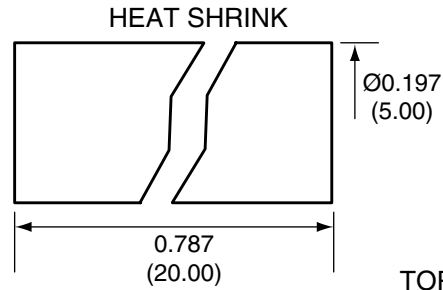

CONMCX012 ASSEMBLY INSTRUCTIONS

1. Strip the cable to the recommended dimensions.
2. Slip heat shrink and crimp ring onto stripped cable.
2. Slide the cable into the body until the center conductor is centered in the fork.
3. Push the braided shield over the barrel.
4. Solder the center conductor into the center of the fork.
5. Slide the crimp ring over the shield and crimp with a 0.128" hex crimp tool (or one labeled for use with RG-174 cable).
6. Trim off any excess shield wire sticking out from the ring.
7. Slip the heat shrink over the crimp ring until it is against the body and shrink.
8. Insert insulator into body.
9. Push the cover into the opening.

NOTES: (UNLESS OTHERWISE SPECIFIED)

1. ALL DIMENSIONS ARE IN INCHES [mm].
2. DIMENSIONS APPLY AFTER FINISHING.
3. MANUFACTURE TO BE COMPLIANT WITH EU RoHS DIRECTIVE.
4. SAFETY BREAK ALL SHARP CORNERS AND EDGES .02 MAXIMUM.

RECOMMENDED CABLE STRIPPING DIMENSIONS

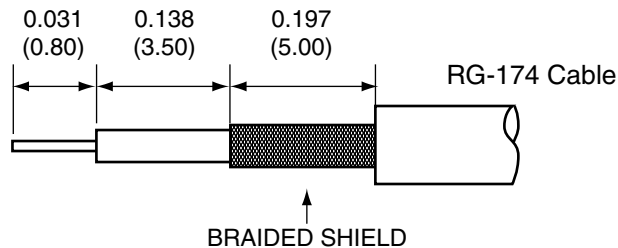

WARNING: THIS DRAWING CONTAINS PROPRIETARY INFORMATION THAT IS THE SOLE PROPERTY OF LINX TECHNOLOGIES, AND SHALL BE TREATED AS SUCH. NO DISCLOSURE OR REPRODUCTION OF THIS DOCUMENT IS PERMITTED, IN WHOLE OR IN PART, WITHOUT THE EXPRESS WRITTEN PERMISSION OF LINX TECHNOLOGIES OR ITS DESIGNATED AGENTS.

MATERIAL:	TOLERANCES: .020 [0.50]-.200 [5.00]= ±.008 [0.20] .200 [5.00]-1.200 [30.00]= ±.016 [0.40] 1.20 [30.0]-4.75 [120.0]= ±.024 [0.60] 4.75 [120.0]-12.40 [315.0]= ±.040 [1.0]	PROJECTION:
FINISH:	DRAWN: B.MURPHY ENGR: S.HOGAN	DT: 12-JUL-12 DT: 12-JUL-12

Linx		159 ORT LANE MERLIN, OR 97532	
TITLE: MCX MALE RIGHT ANGLE CABLE END CRIMP FOR RG174 CABLE			
SIZE A	DWG. NO. CONMCX012	REV B	
SCALE: 2:1	DO NOT SCALE DRAWING	SHEET 1 OF 1	

Mouser Electronics

Authorized Distributor

Click to View Pricing, Inventory, Delivery & Lifecycle Information:

[Linx Technologies:](#)

[CONMCX012](#)