

PART NAME

ALUMINUM INSTRUMENT CASE

PART No.

IA-6161

REVISION DATE

-

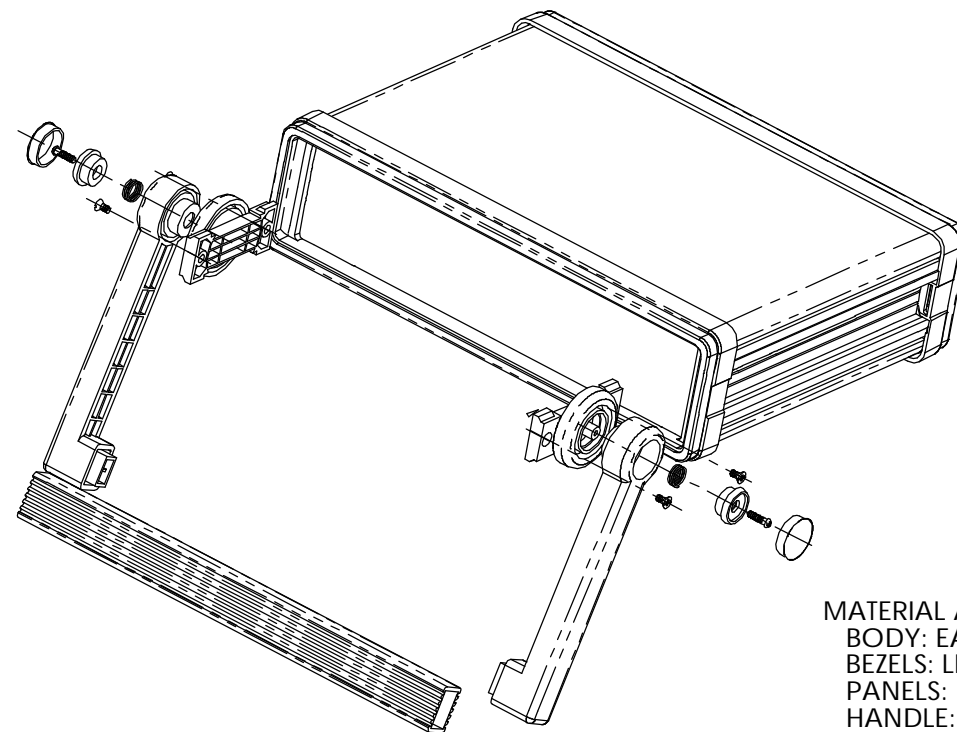
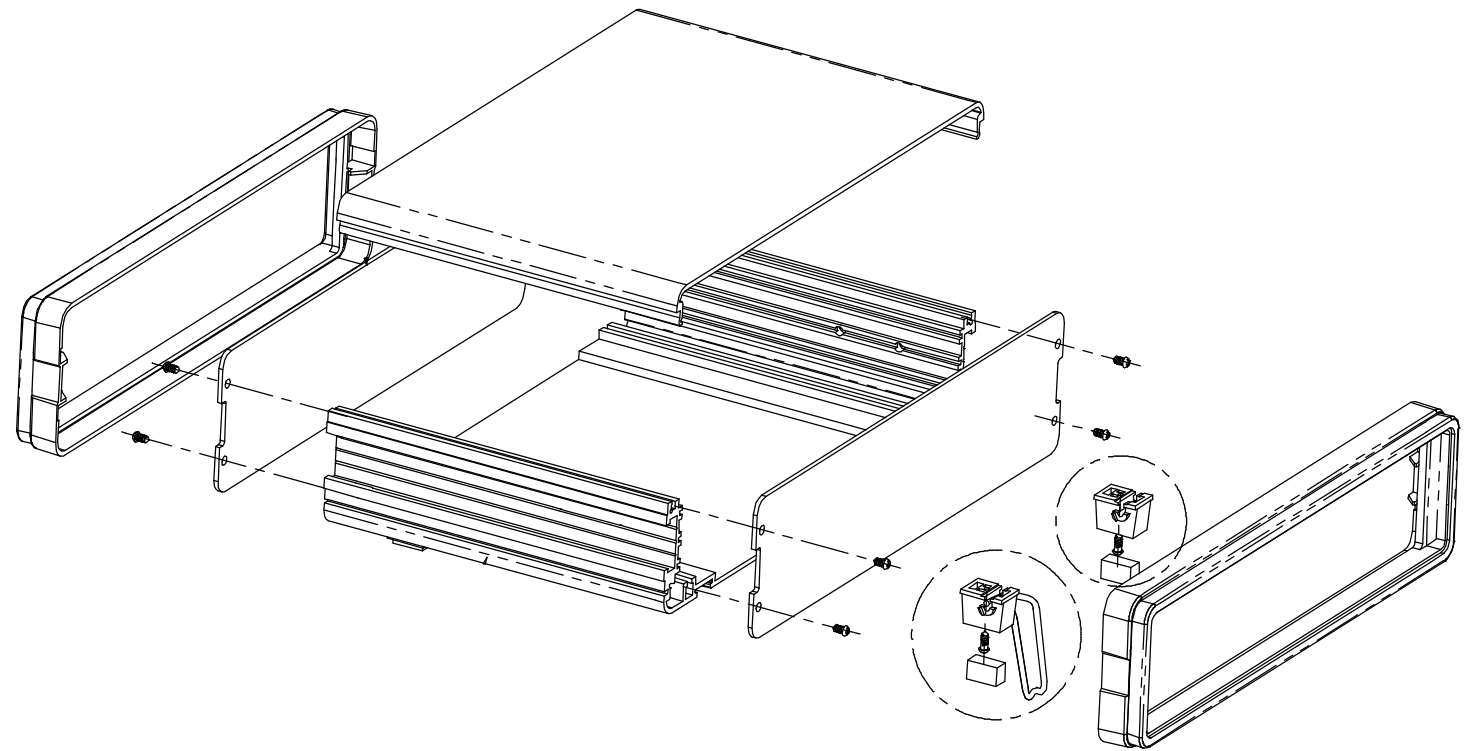
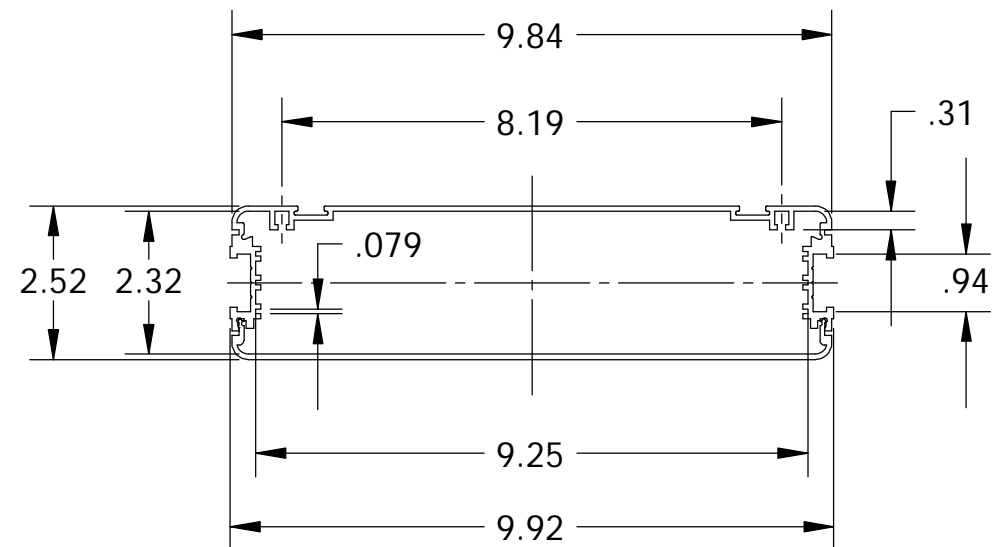
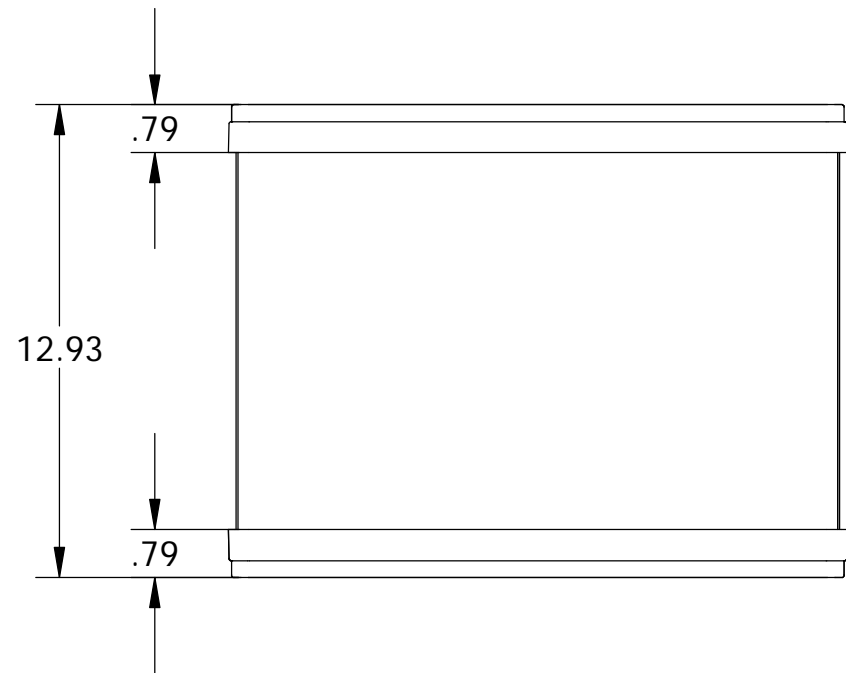
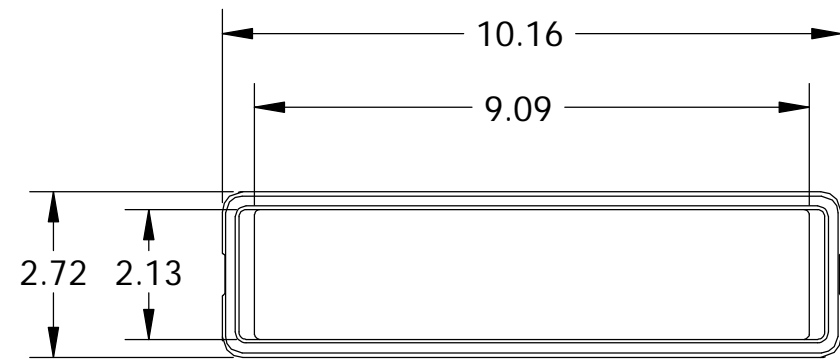

MATERIAL AND FINISH:
 BODY: EARTH TONE POWDER COATED ALUMINUM EXTRUSION
 BEZELS: LIGHT BROWN PLASTIC
 PANELS: NATURAL ALUMINUM
 HANDLE: LIGHT GRAY PLASTIC/ANODIZED ALUMINUM EXTRUSION

DIMENSIONS ARE IN INCHES

Mouser Electronics

Authorized Distributor

Click to View Pricing, Inventory, Delivery & Lifecycle Information:

[Bud Industries:](#)

[IA6161](#) [IA-6161](#)