

**GenX3™ 600V IGBT
w/Diode**
**IXGK72N60A3H1
IXGX72N60A3H1**

 Ultra-Low V_{sat} PT IGBTs for
up to 5kHz Switching



$$\begin{aligned}
 V_{CES} &= 600V \\
 I_{C110} &= 72A \\
 V_{CE(sat)} &\leq 1.35V \\
 t_{fi(typ)} &= 250ns
 \end{aligned}$$

Symbol	Test Conditions	Maximum Ratings	
V_{CES}	$T_J = 25^\circ\text{C}$ to 150°C	600	V
V_{CGR}	$T_J = 25^\circ\text{C}$ to 150°C , $R_{GE} = 1M\Omega$	600	V
V_{GES}	Continuous	± 20	V
V_{GEM}	Transient	± 30	V
I_{C25}	$T_C = 25^\circ\text{C}$	75	A
I_{C110}	$T_C = 110^\circ\text{C}$	72	A
I_{F110}	$T_C = 110^\circ\text{C}$	68	A
I_{CM}	$T_C = 25^\circ\text{C}$, 1ms	400	A
SSOA (RBSOA)	$V_{GE} = 15V$, $T_{VJ} = 125^\circ\text{C}$, $R_G = 3\Omega$ Clamped Inductive Load	$I_{CM} = 150$ $V_{CE} \leq V_{CES}$	A
P_C	$T_C = 25^\circ\text{C}$	540	W
T_J		-55 ... +150	$^\circ\text{C}$
T_{JM}		150	$^\circ\text{C}$
T_{stg}		-55 ... +150	$^\circ\text{C}$
M_d	Mounting Torque (TO-264)	1.13 / 10	Nm/lb.in
F_C	Mounting Force (PLUS247)	20..120 / 4.5..27	N/lb
T_L	Maximum Lead Temperature for Soldering	300	$^\circ\text{C}$
T_{SOLD}	1.6mm (0.062 in.) from Case for 10s	260	$^\circ\text{C}$
Weight	TO-264	10	g
	PLUS247	6	g

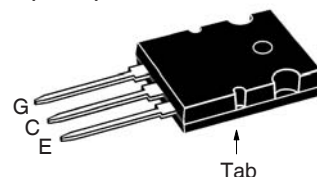
TO-264 (IXGK)

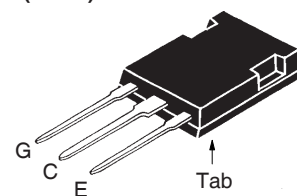

PLUS247 (IXGX)



G = Gate E = Emitter
 C = Collector Tab = Collector

Features

- Optimized for Low Conduction Losses
- Square RBSOA
- Anti-Parallel Ultra Fast Diode
- International Standard Packages

Advantages

- High Power Density
- Low Gate Drive Requirement

Applications

- Power Inverters
- UPS
- Motor Drives
- SMPS
- PFC Circuits
- Battery Chargers
- Welding Machines
- Lamp Ballasts
- Inrush Current Protection Circuits

Symbol	Test Conditions ($T_J = 25^\circ\text{C}$, Unless Otherwise Specified)	Characteristic Values		
		Min.	Typ.	Max.
$V_{GE(th)}$	$I_C = 250\mu\text{A}$, $V_{CE} = V_{GE}$	3.0		5.0 V
I_{CES}	$V_{CE} = V_{CES}$, $V_{GE} = 0V$ $T_J = 125^\circ\text{C}$			300 μA 5 mA
I_{GES}	$V_{CE} = 0V$, $V_{GE} = \pm 20V$			± 100 nA
$V_{CE(sat)}$	$I_C = 60A$, $V_{GE} = 15V$, Note 1			1.35 V

Symbol	Test Conditions	Characteristic Values		
		Min.	Typ.	Max.
g_{fs}	$I_C = 60A, V_{CE} = 10V$, Note 1	48	75	S
C_{ies}	$V_{CE} = 25V, V_{GE} = 0V, f = 1MHz$		6600	pF
C_{oes}			360	pF
C_{res}			80	pF
$Q_{g(on)}$	$I_C = 60A, V_{GE} = 15V, V_{CE} = 0.5 \cdot V_{CES}$		230	nC
Q_{ge}			40	nC
Q_{gc}			80	nC
$t_{d(on)}$	Inductive load, $T_J = 25^\circ C$ $I_C = 50A, V_{GE} = 15V$ $V_{CE} = 480V, R_G = 3\Omega$		31	ns
t_{ri}			34	ns
E_{on}			1.4	mJ
$t_{d(off)}$			320	ns
t_{fi}			250	ns
E_{off}			3.5	mJ
$t_{d(on)}$	Inductive load, $T_J = 125^\circ C$ $I_C = 50A, V_{GE} = 15V$ $V_{CE} = 480V, R_G = 3\Omega$		29	ns
t_{ri}			34	ns
E_{on}			2.6	mJ
$t_{d(off)}$			510	ns
t_{fi}			375	ns
E_{off}			6.5	mJ
R_{thJC}			0.23	$^\circ C/W$
R_{thCS}		0.15		$^\circ C/W$

Reverse Diode (FRED)

Symbol	Test Conditions	Characteristic Values		
		Min.	Typ.	Max.
V_F	$I_F = 60A, V_{GE} = 0V$, Note 1		1.6	2.3 V
	$T_J = 150^\circ C$		1.4	1.8 V
I_{RM}	$I_F = 60A, V_{GE} = 0V$, $T_J = 100^\circ C$		8.3	A
t_{rr}	$I_F = 60A, -di/dt = 200A/\mu s, V_R = 300V$		140	ns
R_{thJC}				0.3 $^\circ C/W$

Note 1: Pulse test, $t \leq 300\mu s$, duty cycle, $d \leq 2\%$.

PRELIMINARY TECHNICAL INFORMATION

The product presented herein is under development. The Technical Specifications offered are derived from a subjective evaluation of the design, based upon prior knowledge and experience, and constitute a "considered reflection" of the anticipated result. IXYS reserves the right to change limits, test conditions, and dimensions without notice.

TO-264 Outline

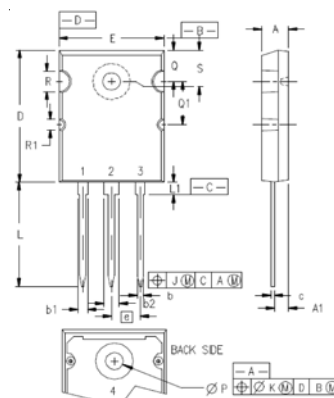

Terminals: 1 = Gate
2,4 = Collector
3 = Emitter

SYM	INCHES		MILLIMETERS	
	MIN	MAX	MIN	MAX
A	.185	.209	4.70	5.31
A1	.102	.118	2.59	3.00
b	.037	.055	0.94	1.40
b1	.087	.102	2.21	2.59
b2	.110	.126	2.79	3.20
c	.017	.029	0.43	0.74
D	1.007	1.047	25.58	26.59
E	.760	.799	19.30	20.29
e	.215 BSC		5.46 BSC	
J	.000	.010	0.00	0.25
K	.000	.010	0.00	0.25
L	.779	.842	19.79	21.39
L1	.087	.102	2.21	2.59
ØP	.122	.138	3.10	3.51
Q	.240	.256	6.10	6.50
Q1	.330	.346	8.38	8.79
ØR	.155	.187	3.94	4.75
ØR1	.085	.093	2.16	2.36
S	.243	.253	6.17	6.43

PLUS247™ Outline

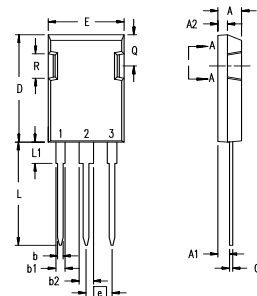

Terminals: 1 - Gate
2 - Collector
3 - Emitter

Dim.	Millimeter		Inches	
	Min.	Max.	Min.	Max.
A	4.83	5.21	.190	.205
A ₁	2.29	2.54	.090	.100
A ₂	1.91	2.16	.075	.085
b	1.14	1.40	.045	.055
b ₁	1.91	2.13	.075	.084
b ₂	2.92	3.12	.115	.123
C	0.61	0.80	.024	.031
D	20.80	21.34	.819	.840
E	15.75	16.13	.620	.635
e	5.45 BSC		.215 BSC	
L	19.81	20.32	.780	.800
L1	3.81	4.32	.150	.170
Q	5.59	6.20	.220	0.244
R	4.32	4.83	.170	.190

IXYS Reserves the Right to Change Limits, Test conditions, and Dimensions.

IXYS MOSFETs and IGBTs are covered by one or more of the following U.S. patents:	4,835,592	4,931,844	5,049,961	5,237,481	6,162,665	6,404,065 B1	6,683,344	6,727,585	7,005,734 B2	7,157,338 B2
	4,860,072	5,017,508	5,063,307	5,381,025	6,259,123 B1	6,534,343	6,710,405 B2	6,759,692	7,063,975 B2	
	4,881,106	5,034,796	5,187,117	5,486,715	6,306,728 B1	6,583,505	6,710,463	6,771,478 B2	7,071,537	

Fig. 1. Output Characteristics @ $T_J = 25^\circ\text{C}$

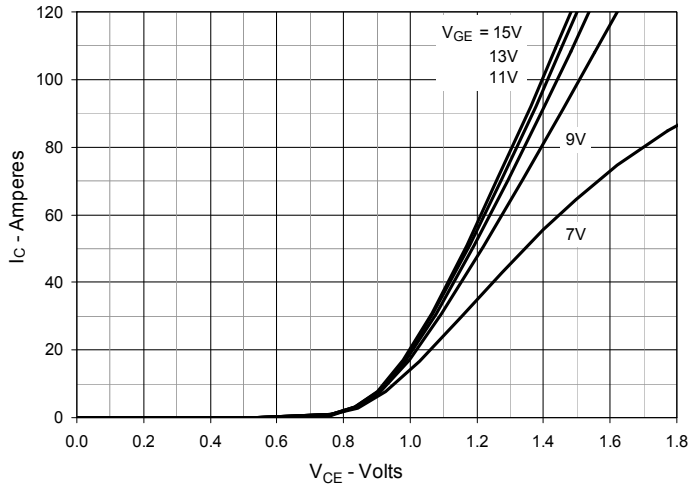

Fig. 2. Extended Output Characteristics @ $T_J = 25^\circ\text{C}$

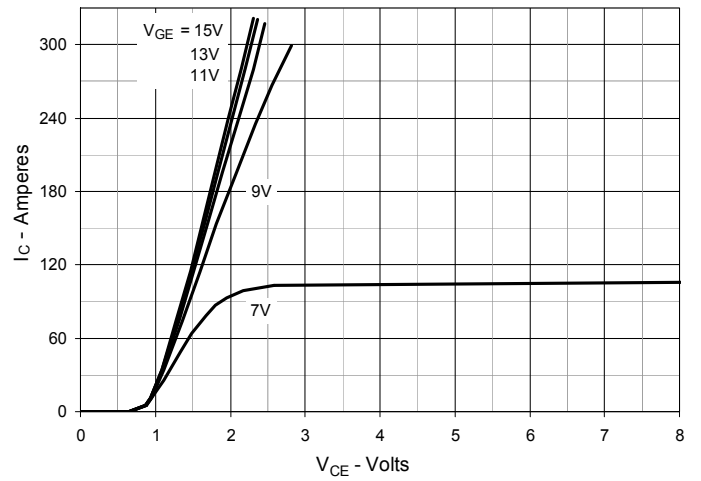

Fig. 3. Output Characteristics @ $T_J = 125^\circ\text{C}$

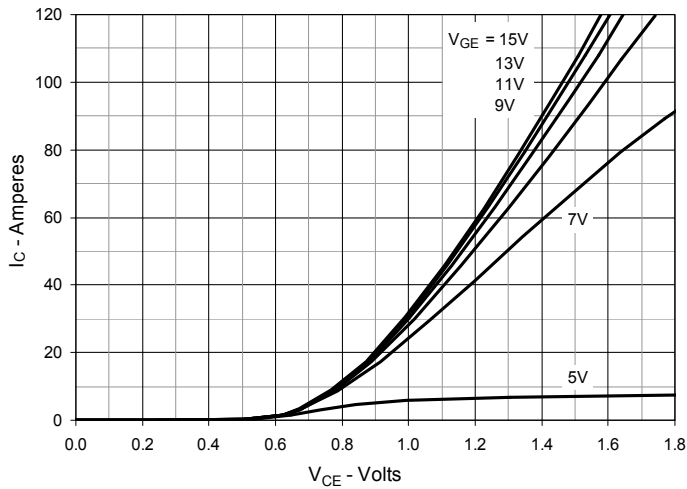

Fig. 4. Dependence of $V_{CE(sat)}$ on Junction Temperature

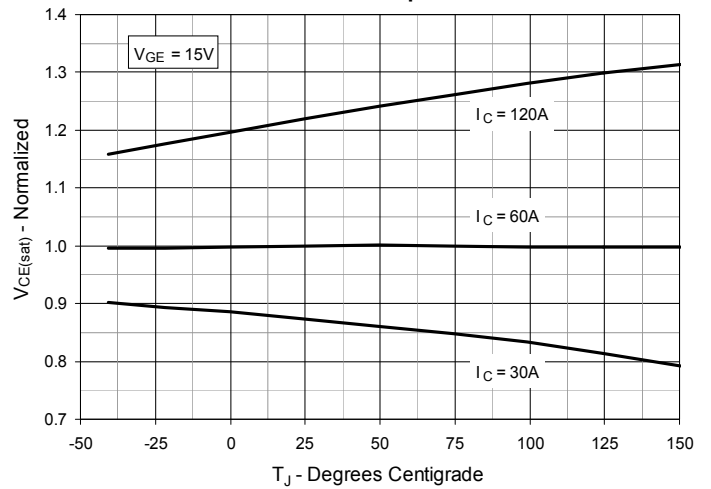

Fig. 5. Collector-to-Emitter Voltage vs. Gate-to-Emitter Voltage

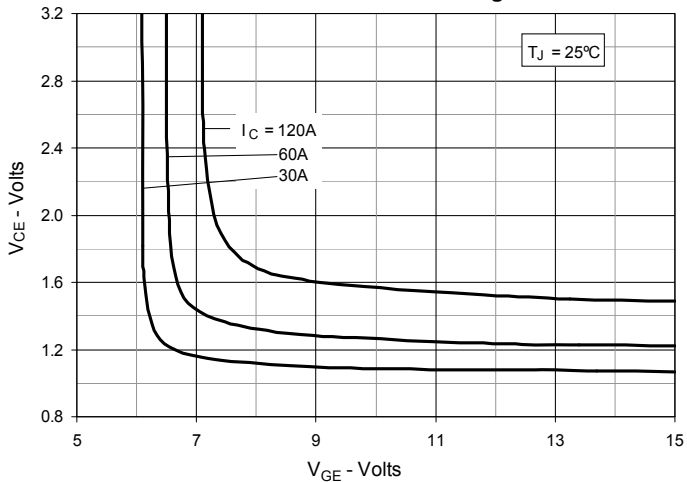

Fig. 6. Input Admittance

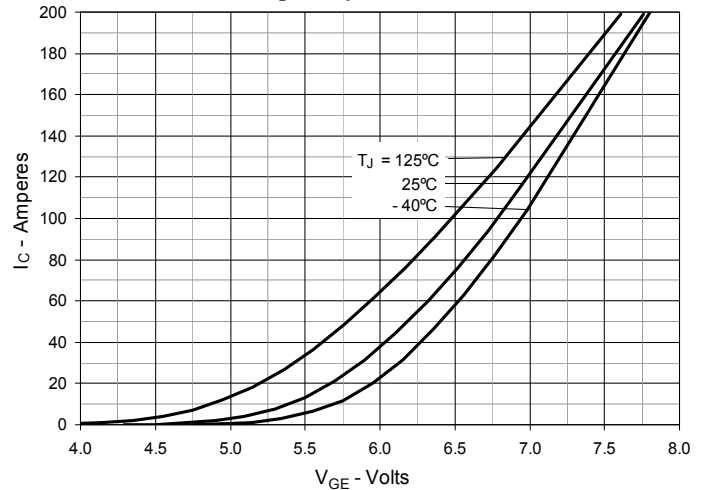

Fig. 7. Transconductance

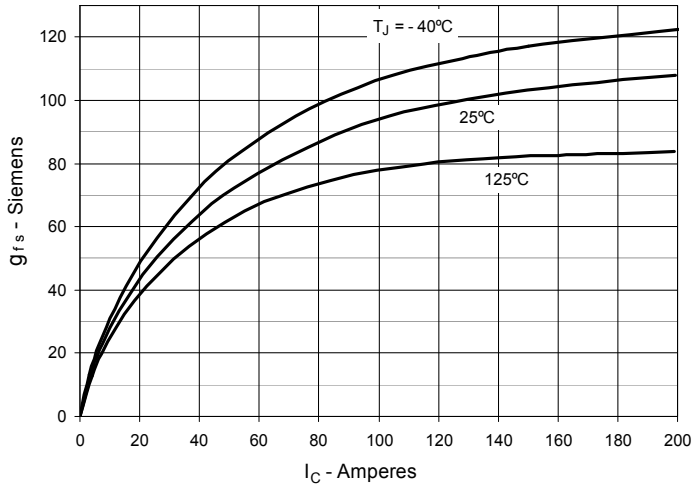

Fig. 8. Gate Charge

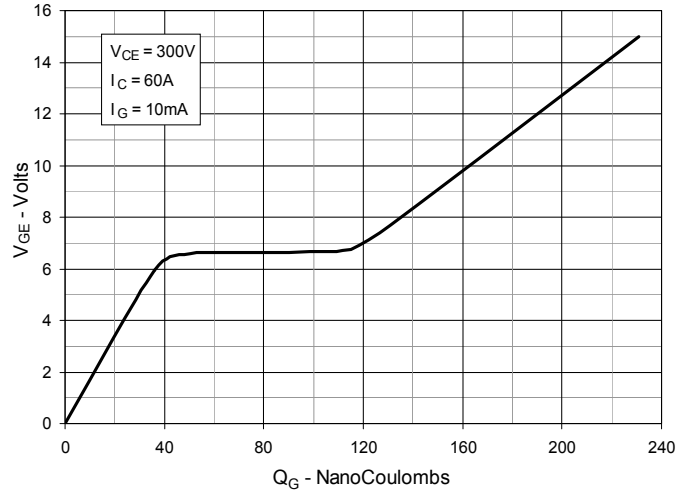

Fig. 9. Capacitance

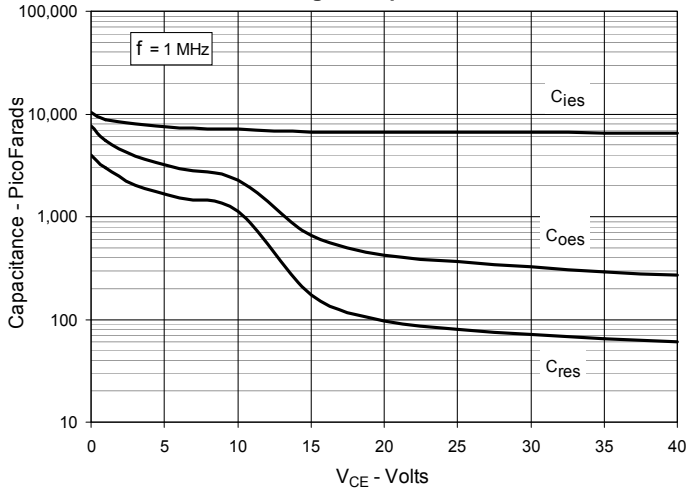

Fig. 10. Reverse-Bias Safe Operating Area

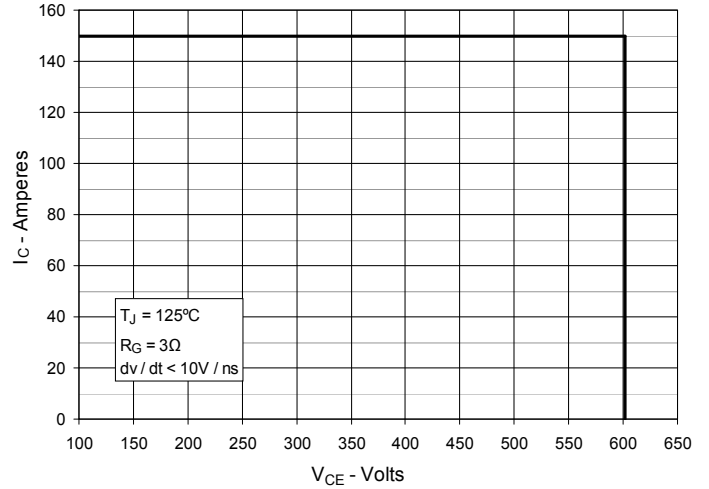

Fig. 11. Maximum Transient Thermal Impedance

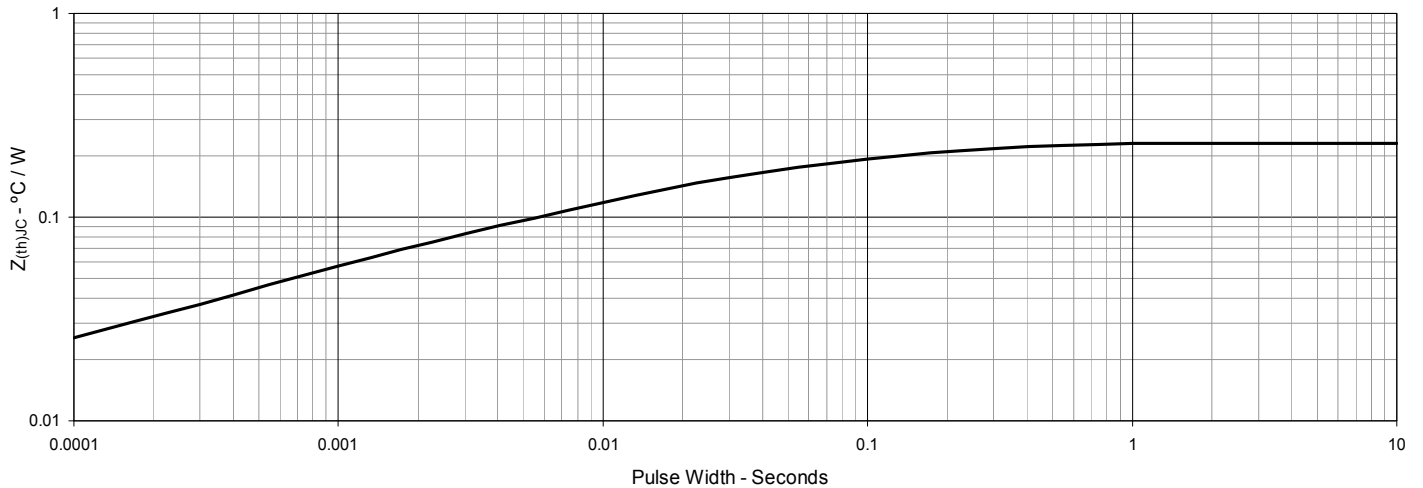

Fig. 12. Inductive Switching Energy Loss vs. Gate Resistance

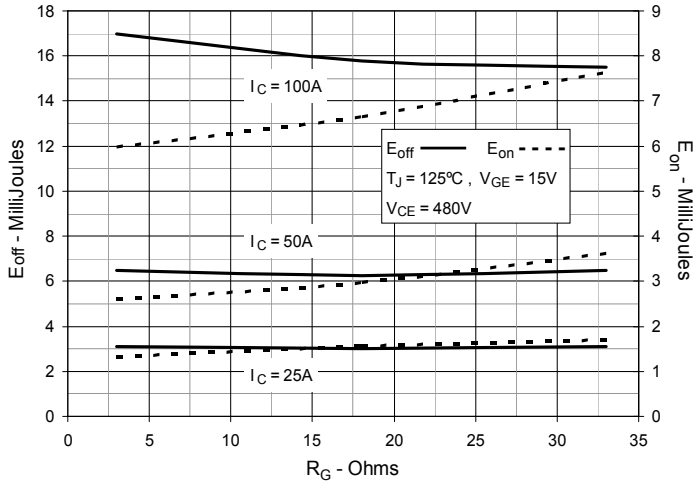

Fig. 13. Inductive Switching Energy Loss vs. Collector Current

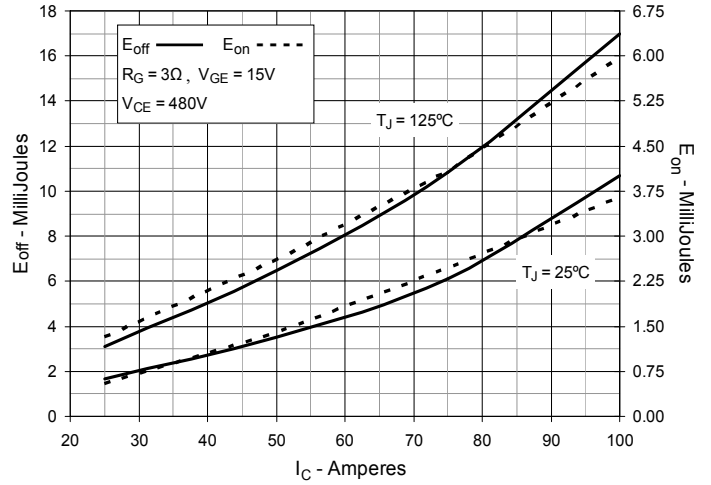

Fig. 14. Inductive Switching Energy Loss vs. Junction Temperature

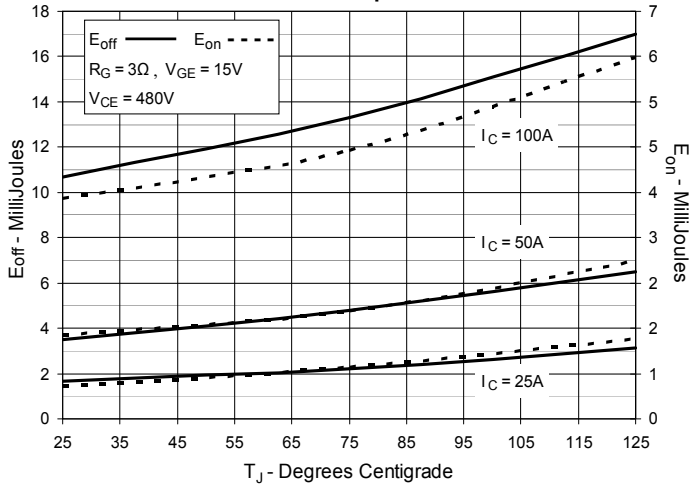

Fig. 15. Inductive Turn-off Switching Times vs. Gate Resistance

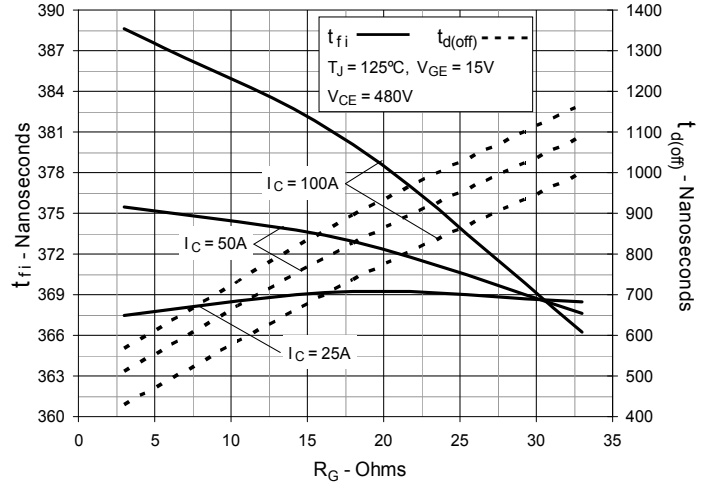

Fig. 16. Inductive Turn-off Switching Times vs. Collector Current

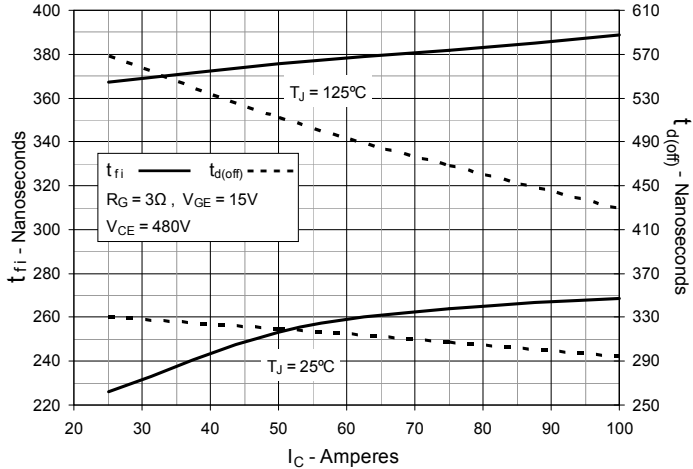

Fig. 17. Inductive Turn-off Switching Times vs. Junction Temperature

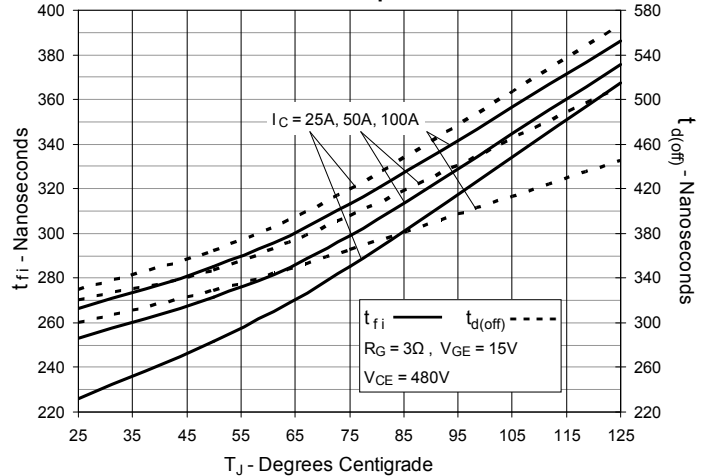

Fig. 18. Inductive Turn-on Switching Times vs. Gate Resistance

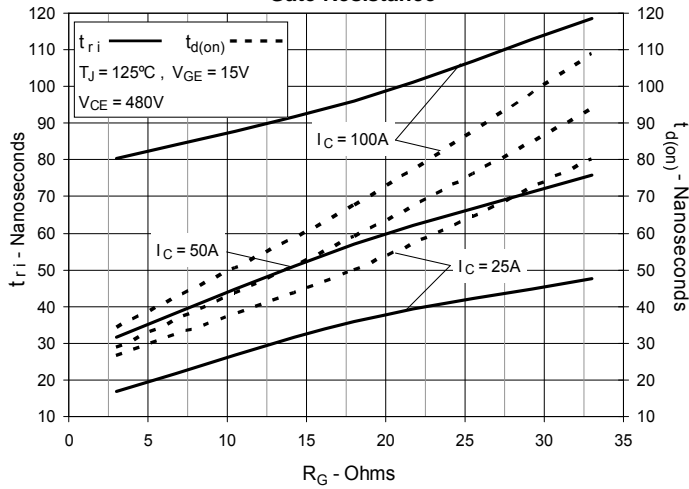

Fig. 19. Inductive Turn-on Switching Times vs. Collector Current

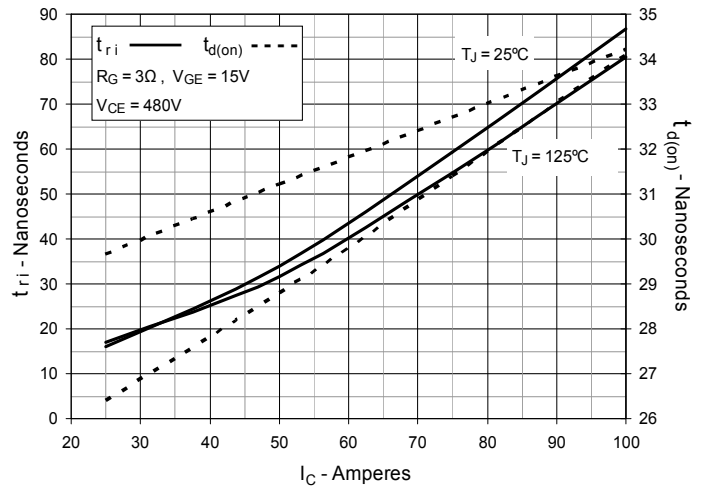
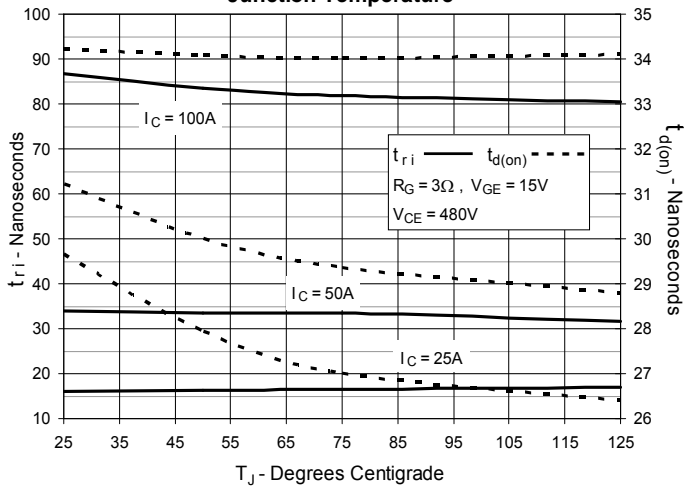

Fig. 20. Inductive Turn-on Switching Times vs. Junction Temperature



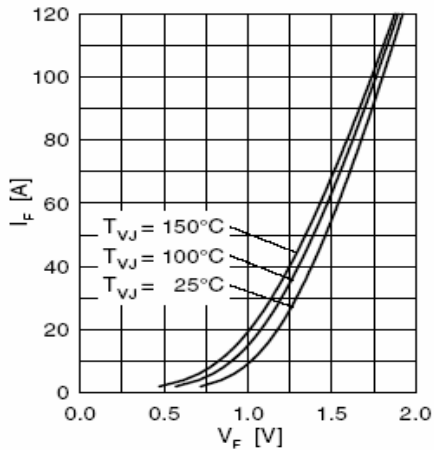

Fig. 21 Forward current I_F vs. V_F

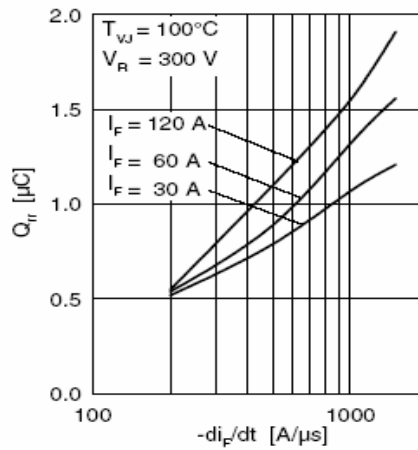

Fig. 22 Typ. reverse recovery charge Q_{rr}

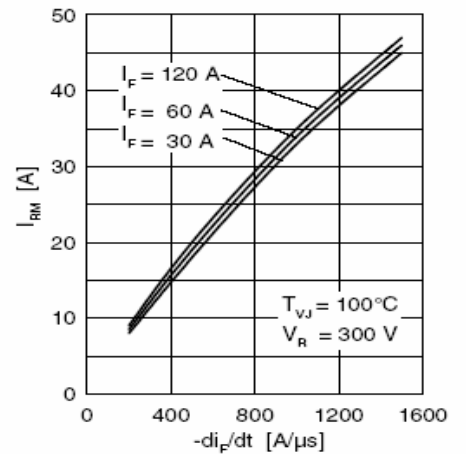

Fig. 23 Typ. peak reverse current I_{RM}



Fig. 24 Typ. dynamic parameters Q_{rr} , I_{RM}



Fig. 25 Typ. recovery time t_{rr}

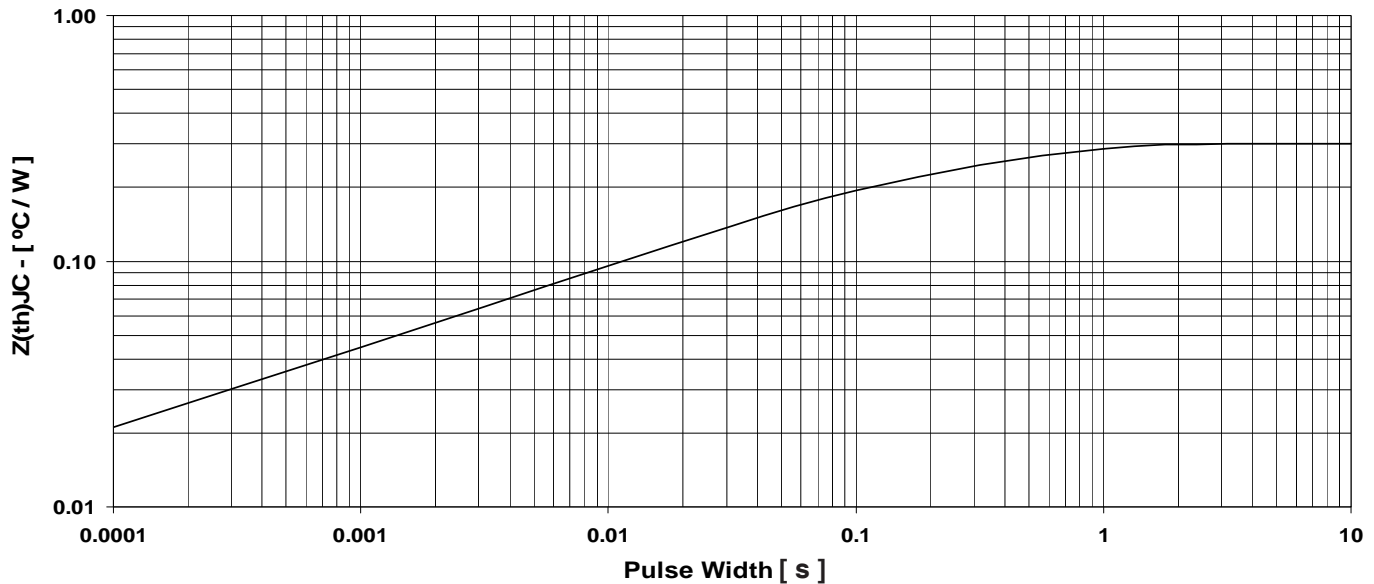

Fig. 26 Maximum transient thermal impedance junction to case (for diode)

Mouser Electronics

Authorized Distributor

Click to View Pricing, Inventory, Delivery & Lifecycle Information:

[IXYS:](#)

[IXGK72N60A3H1](#) [IXGX72N60A3H1](#)