

NTC/PTC Thermistors for Automotive

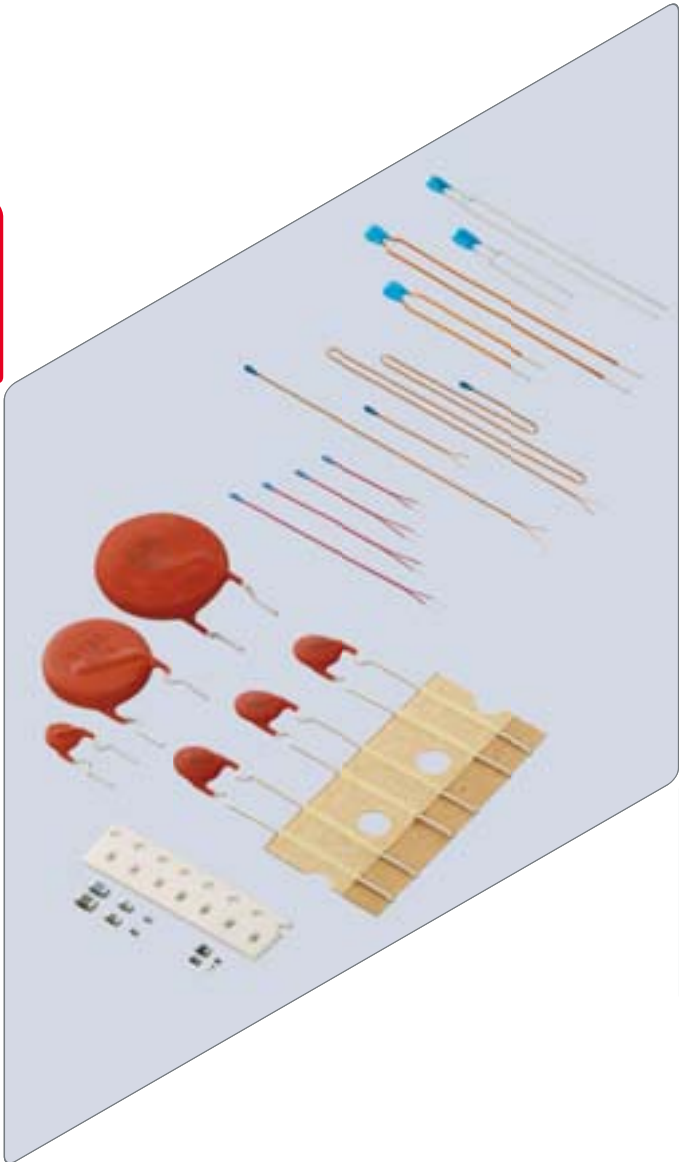



EU RoHS Compliant

- All the products in this catalog comply with EU RoHS.
- EU RoHS is "the European Directive 2011/65/EU on the Restriction of the Use of Certain Hazardous Substances in Electrical and Electronic Equipment."
- For more details, please refer to our web page, "Murata's Approach for EU RoHS" (<https://www.murata.com/en-eu/support/compliance/rohs>).

Contents

Product specifications are as of February 2020.

Part Numbering	p2
Basic Characteristics of NTC Thermistor	p7
Basic Characteristics of POSISTOR	p8
1 NTC Thermistor Chip Type 0402 (1005) Size (Meet AEC-Q200 rev.D)	p9
2 NTC Thermistor Chip Type 0603 (1608) Size (Meet AEC-Q200 rev.D)	p10
3 NTC Thermistor Chip Type 0603 (1608) Size for Conductive Glue	p11
NTC Thermistors Chip Type	
Standard Land Pattern Dimensions	p12
Temperature Characteristics (Center Value) ..	p13
Specifications and Test Methods	p15
⚠Caution/Notice	p18
4 NTC Thermistor Thermo String Cooper Wire Type for Temperature Sensor	p22
NTC Thermistor Thermo String Nickel Copper Wire Type for Temperature Sensor	p23
Temperature Characteristics (Center Value) ..	p24
Specifications and Test Methods	p25
⚠Caution/Notice	p27
5 NTC Thermistors Temperature Sensor Lead Type	p28
Specifications and Test Methods	p29
6 NTC Thermistors Temperature Sensor Lead Insulation Type	p30
Specifications and Test Methods	p31
NTC Thermistors Temperature Sensor Lead/Lead Insulation Type	
Temperature Characteristics (Center Value)	p32
⚠Caution/Notice	p33
NTC Thermistors Chip Type/Thermo String/Lead Type Package	
7 PTC Thermistor (POSISTOR) for Overheat Sensing Chip Type 0603 (1608) Size (Meet AEC-Q200 rev.D) ..	p38
Specifications and Test Methods	p43
8 PTC Thermistor (POSISTOR) for Overcurrent Protection Chip Type 0603 (1608) Size (Meet AEC-Q200 rev.D) ..	p45
Specifications and Test Methods	p48
9 PTC Thermistor (POSISTOR) for Overcurrent Protection Chip Type 0805 (2012) Size (Meet AEC-Q200 rev.D) ..	p50
Specifications and Test Methods	p54
POSISTOR Chip Type ⚠Caution/Notice	p58
10 PTC Thermistor (POSISTOR) for Overcurrent Protection Lead Type	p67
Specifications and Test Methods	p77
⚠Caution/Notice	p80
POSISTOR Chip Type Package	p81
POSISTOR Lead Type Package	p82

Please check the MURATA website (<https://www.murata.com/>) if you cannot find a part number in this catalog.

● Part Numbering

NTC Thermistors for Temperature Compensation Chip Type

(Part Number)

NC	P	18	XH	103	J	0S	RB
①	②	③	④	⑤	⑥	⑦	⑧

① Product ID

Product ID	
NC	NTC Thermistors Chip Type

② Series

Code	Series
G	Conductive Glue Series
P	Plated Termination Series
U	High Reliability Series

③ Dimensions (L x W)

Code	Dimensions (L x W)	EIA
15	1.00 x 0.50mm	0402
18	1.60 x 0.80mm	0603

④ Temperature Characteristics

Code	Temperature Characteristics
WB	Nominal B-Constant 4050-4099K
WD	Nominal B-Constant 4150-4199K
WF	Nominal B-Constant 4250-4299K
WL	Nominal B-Constant 4450-4499K
WM	Nominal B-Constant 4500-4549K
XC	Nominal B-Constant 3100-3149K
XF	Nominal B-Constant 3250-3299K
XH	Nominal B-Constant 3350-3399K
XM	Nominal B-Constant 3500-3549K
XQ	Nominal B-Constant 3650-3699K
XV	Nominal B-Constant 3900-3949K
XW	Nominal B-Constant 3950-3999K

⑤ Resistance

Expressed by three figures. The unit is ohm (Ω). The first and second figures are significant digits, and the third figure expresses the number of zeros that follow the two figures.

Ex.)

Code	Resistance
102	1k Ω
103	10k Ω
104	100k Ω

⑥ Resistance Tolerance

Code	Resistance Tolerance
D	$\pm 0.5\%$
E	$\pm 3\%$
F	$\pm 1\%$
J	$\pm 5\%$

⑦ Individual Specifications

Structures and others are expressed by two figures.

Code	Individual Specifications
□S	for Automotive

⑧ Packaging

Code	Packaging
RB	Paper Taping 4mm Pitch (4000 pcs.)
RC	Paper Taping 2mm Pitch (10000 pcs.)

NTC Thermistor for Temperature Sensor Thermo String Type

(Part Number)

NXF	S	15	XH	103	F	A	2	B	025
①	②	③	④	⑤	⑥	⑦	⑧	⑨	⑩

① Product ID

Product ID	
NXF	NTC Thermistors Sensor Thermo String Type

② Individual Specifications

Code	Individual Specifications
S	for Automotive

③ Chip Dimensions

Code	Dimensions (L x T)	EIA
15	1.00 x 0.50mm	0402

④ Temperature Characteristics

Code	Temperature Characteristics
WB	Nominal B-Constant 4050–4099K
WF	Nominal B-Constant 4250–4299K
XH	Nominal B-Constant 3350–3399K
XM	Nominal B-Constant 3500–3549K
XV	Nominal B-Constant 3900–3949K

⑤ Resistance

Expressed by three figures. The unit is (Ω). The first and second figures are significant digits, and the third figure expresses the number of zeros that follow the two figures.

Ex.

Code	Resistance
103	10kΩ
473	47kΩ
104	100kΩ

⑥ Resistance Tolerance

Code	Resistance Tolerance
F	±1%
E	±3%

⑦ Lead Wire Type

Code	Lead Wire Type
A	φ0.3mm Copper Lead Wire with Polyurethane Coat
E	φ0.3mm Nickel Copper Lead Wire with Modified Polyester Coat

⑧ Shape of the Lead Wire Kink

Code	Shape of the Lead Wire Kink
1	The Twist of Lead Wire Type
2	Standard Type (Cooper Wire Type)
A	Standard Type (Nickel Copper Wire Type)

⑨ Packaging

Code	Packaging
B	Bulk

⑩ Dimensions (Full Length)

Code	Dimensions (Full Length)
021	21mm
025	25mm
030	30mm
035	35mm
040	40mm
045	45mm
050	50mm
060	60mm
070	70mm
080	80mm
090	90mm
100	100mm
110	110mm
120	120mm
130	130mm
140	140mm
150	150mm

NTC Thermistor for Temperature Sensor/Lead Type

(Part Number)

NXR	S	15	XH	103	F	A	1	B	040
①	②	③	④	⑤	⑥	⑦	⑧	⑨	⑩

① Product ID

Product ID	
NXR	NTC Thermistor Sensor/Lead Type

② Individual Specifications

Code	Individual Specifications
S	Automotive Type

③ Chip Dimensions

Code	Dimensions (L x T)
15	1.00 x 0.50mm

④ Temperature Characteristics

Code	Temperature Characteristics
XH	Nominal B-Constant 3350–3399K
XM	Nominal B-Constant 3500–3549K
XV	Nominal B-Constant 3900–3949K
WB	Nominal B-Constant 4050–4099K
WF	Nominal B-Constant 4250–4299K

⑤ Resistance

Expressed by three figures. The unit is (Ω). The first and second figures are significant digits, and the third figure expresses the number of zeros that follow the two figures.

Ex.

Code	Resistance
202	2.0kΩ
103	10kΩ
104	100kΩ

⑥ Resistance Tolerance

Code	Resistance Tolerance
F	±1%
E	±3%
J	±5%

⑦ Lead Wire Type

Code	Lead Wire Type
A	Lead Type: ø0.4mm Copper-clad Fe Wire, Tinned Lead Insulation Type: ø0.46mm Cu Wire with Coat

⑧ Shape of the Lead Wire

Code	Shape of the Lead Wire
1	Lead Spacing 2.5mm
3	Lead Spacing 5.0mm
5	Lead Spacing 2.5mm (Insulation Type)

⑨ Packaging

Code	Packaging
A	Ammo Pack Taping
B	Bulk

⑩ Dimensions (Full Length)

Code	Lead Type	Lead Insulation Type
010	10mm	–
020	20mm	–
025	–	25mm
030	30mm	30mm
035	–	35mm
040	40mm	40mm
045	–	45mm
050	50mm	50mm
016	16mm (Taping Type)	–

PTC Thermistors (POSISTOR) for Overheat Sensing Chip Type

(Part Number)

PR	F	18	BB	471	Q	S5	RB
①	②	③	④	⑤	⑥	⑦	⑧

① Product ID

Product ID	
PR	PTC Thermistors Chip Type

② Series

Code	Series
F	for Overheat Sensing

③ Dimensions (L x W)

Code	Dimensions (L x W)
18	1.60 x 0.80mm

④ Temperature Characteristics

Code	Temperature Characteristics-Curie Point
AS	130°C
AR	120°C
BA	110°C
BB	100°C
BC	90°C
BD	80°C
BE	70°C
BF	60°C
BG	50°C

⑤ Resistance

Expressed by three figures. The unit is ohm (Ω). The first and second figures are significant digits, and the third figure expresses the number of zeros that follow the two figures.

Ex.)

Code	Resistance
471	470 Ω

⑥ Resistance Tolerance

Code	Resistance Tolerance	Sensing Temp. Tolerance
Q	Special Tolerance	$\pm 5^\circ\text{C}$
R	Special Tolerance	$\pm 3^\circ\text{C}$

⑦ Individual Specifications

Code	Individual Specifications
S5	for Automotive

⑧ Packaging

Code	Packaging
RB	Paper Taping (4mm Pitch) (4000 pcs.)

PTC Thermistors (POSISTOR) for Overcurrent Protection Chip Type

(Part Number)

PR	G	21	AR	420	M	S1	RA
①	②	③	④	⑤	⑥	⑦	⑧

① Product ID

Product ID	
PR	PTC Thermistors Chip Type

② Series

Code	Series
G	for Overcurrent Protection

③ Dimensions (L x W)

Code	Dimensions (L x W)
18	1.60 x 0.80mm
21	2.00 x 1.25mm

④ Temperature Characteristics

Code	Temperature Characteristics
AR	Curie Point 120°C
BB	Curie Point 100°C
BC	Curie Point 90°C

⑤ Resistance

Expressed by three-digit alphanumerics. The unit is ohm (Ω). The first and second figures are significant digits, and the third figure expresses the number of zeros that follow the two figures. If there is a decimal point, it is expressed by the capital letter "R." In this case, all figures are significant digits.

Ex.)

Code	Resistance
4R7	4.7 Ω
420	42 Ω

⑥ Resistance Tolerance

Code	Resistance Tolerance
M	$\pm 20\%$
Q	Special Tolerance

⑦ Individual Specifications

Ex.)

Code	Individual Specifications
S□	for Automotive

⑧ Packaging

Code	Packaging
RA	Embossed Taping (4mm Pitch) (4000 pcs.)
RB	Paper Taping (4mm Pitch) (4000 pcs.)
RK	Embossed Taping (4mm Pitch) (3000 pcs.)

PTC Thermistors (POSISTOR) for Overcurrent Protection Lead Type

(Part Number)

PT	GL	4	S	AS	220	K	4B51	B0
①	②	③	④	⑤	⑥	⑦	⑧	⑨

① Product ID

Product ID	
PT	PTC Thermistors

② Series

Code	Series
GL	for Overcurrent Protection Lead Type

③ Dimensions

Code	Dimensions
4	Nominal Body Diameter 4mm Series
5	Nominal Body Diameter 5mm Series
6	Nominal Body Diameter 6mm Series
7	Nominal Body Diameter 7mm Series
9	Nominal Body Diameter 9mm Series
A	Nominal Body Diameter 10mm Series
C	Nominal Body Diameter 12mm Series
E	Nominal Body Diameter 14mm Series

④ Individual Specifications

Code	Individual Specifications
S	for Automotive

⑤ Temperature Characteristics

Code	Temperature Characteristics
AS	Curie Point 130°C
AR	Curie Point 120°C

⑥ Resistance

Expressed by three-digit alphanumeric. The unit is ohm (Ω). The first and second figures are significant digits, and the third figure expresses the number of zeros that follow the two figures. If there is a decimal point, it is expressed by the capital letter "R." In this case, all figures are significant digits.

Ex.)

Code	Resistance
R22	0.22 Ω
2R2	2.2 Ω
220	22 Ω

⑦ Resistance Tolerance

Code	Resistance Tolerance
K	$\pm 10\%$
M	$\pm 20\%$

⑧ Individual Specifications

Ex.)

Code	Individual Specifications
4B51	Lead Type, others

⑨ Packaging

Code	Packaging
A0	Ammo Pack
B0	Bulk

Basic Characteristics of NTC Thermistor

Basic Characteristics

1. Zero-power Resistance of Thermistor: R

Measured by zero-power in specified ambient temperatures.

$$R = R_0 \exp B (1/T - 1/T_0) \dots\dots\dots (1)$$

R: Resistance in ambient temperature T (K)
 (K: absolute temperature)

R₀: Resistance in ambient temperature T₀ (K)

B: B-constant of Thermistor

2. B-Constant

as (1) formula

$$B = \ln (R/R_0) / (1/T - 1/T_0)$$

3. Thermal Dissipation Constant

When electric power P (mW) is spent in ambient temperature T₁ and thermistor temperature rises T₂, the formula is as follows;

$$P = C (T_2 - T_1)$$

C: Thermal dissipation constant (mW/°C)

Thermal dissipation constant varies with dimensions, measurement conditions, etc.

4. Thermal Time Constant

Period in which Thermistor's temperature will change 63.2% of its temperature difference from ambient temperature T₀ (°C) to T₁ (°C).

5. Maximum Operating Current

It is possible to keep Thermistor's temperature rising max. 0.1°C.

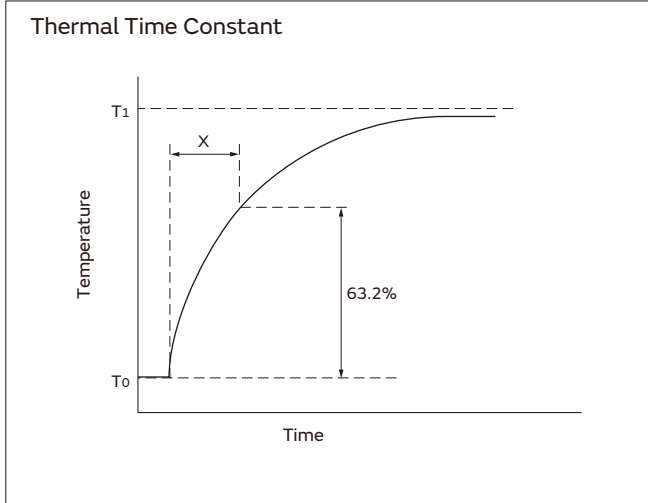
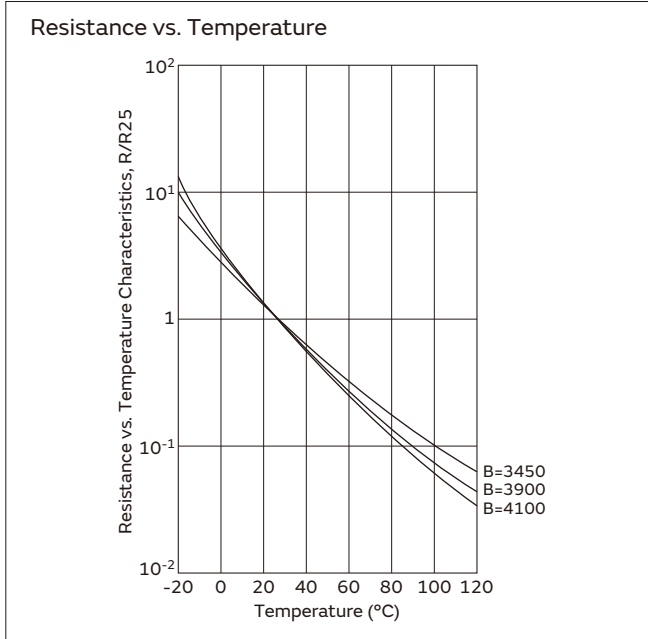

Basic Characteristics of POSISTOR

Basic Characteristics

POSISTOR has three main characteristics.

1. Resistance-Temperature Characteristics

Although there is a negligible difference between the normal and "Curie Point" temperature, POSISTOR shows almost constant resistance-temperature characteristics. Yet they have resistance-temperature characteristics that cause resistance to sharply increase when the temperature exceeds the Curie Point. The Curie Point (C.P.) is defined as the temperature at which the resistance value is twice the one at 25 °C.

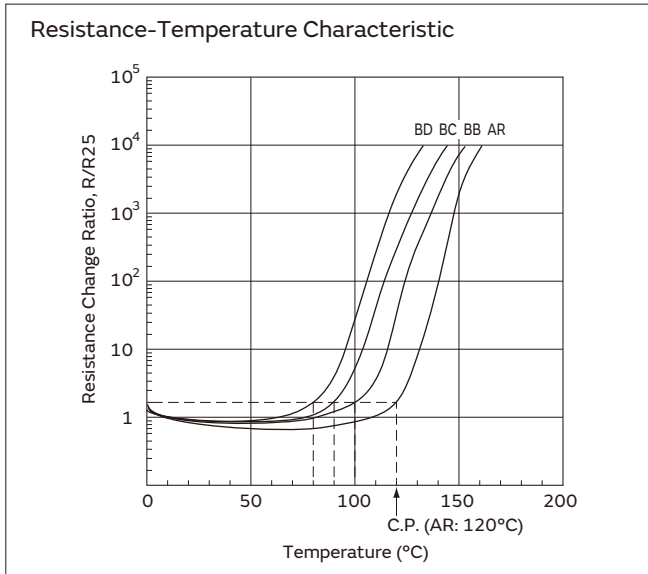

2. Current-Voltage Characteristics (Static Characteristics)

This shows the relation between applied voltage when voltage applied to POSISTOR causes balancing of inner heating and outer thermal dissipation and stabilized current. This has both a maximum point of current and constant output power.

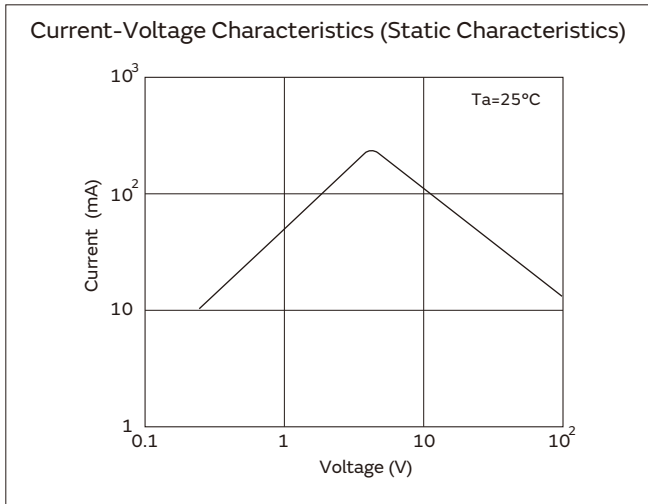

3. Current-Time Characteristics (Dynamic Characteristics)

This shows the relation between current and time before inner heating and outer thermal dissipation arrive at equilibrium state. This features having large initial current and abruptly continuous attenuating portion.

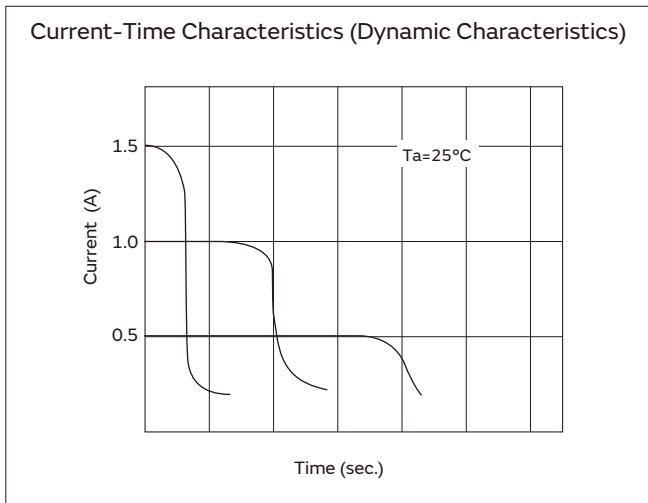

NTC Thermistors for Automotive

Chip Type 0402 (1005) Size (Meet AEC-Q200 rev.D)

Chip NTC Thermistors have Ni barrier termination, provide excellent solderability and offer high stability in environment due to unique inner construction.

Available Market is Automotive market where request the high reliability.

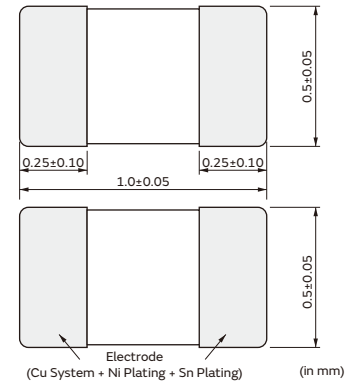

Features

1. Excellent solderability and high stability in environment
2. Excellent long time aging stability
3. High accuracy in resistance and B-constant
4. Reflow soldering possible
5. Lead is not contained in the product
6. NCU series are recognized by UL/cUL.
 (UL1434, File No.E137188)

Detailed are accessible from the following URL.
<https://www.murata.com/en-global/products/thermistor/ntc/ncu>

Applications

1. Car audio, car navigation
2. Various engine control units
3. Circuits for ETC equipment
4. Various motor driving circuits
5. Temperature compensation for various circuits

Part Number	Resistance (25°C) (ohm)	B-Constant (25-50°C) (K)	B-Constant (25-80°C) (Reference Value) (K)	B-Constant (25-85°C) (Reference Value) (K)	B-Constant (25-100°C) (Reference Value) (K)	Maximum Operating Current (25°C) (mA)	Maximum Voltage (V)	Typical Dissipation Constant (25°C) (mW/°C)
NCU15XH103D6SRC	10k ±0.5%	3380 ±0.7%	3428	3434	3455	0.100	5	1
NCU15XH103F6SRC	10k ±1%	3380 ±1%	3428	3434	3455	0.100	5	1
NCU15XH103□6SRC	10k	3380 ±1%	3428	3434	3455	0.100	5	1
NCU15WB473D6SRC	47k ±0.5%	4050 ±0.5%	4101	4108	4131	0.046	5	1
NCU15WB473F6SRC	47k ±1%	4050 ±1%	4101	4108	4131	0.046	5	1
NCU15WB473□6SRC	47k	4050 ±1%	4101	4108	4131	0.046	5	1
NCU15WF104D6SRC	100k ±0.5%	4250 ±0.5%	4303	4311	4334	0.032	5	1
NCU15WF104F6SRC	100k ±1%	4250 ±1%	4303	4311	4334	0.032	5	1
NCU15WF104□6SRC	100k	4250 ±1%	4303	4311	4334	0.032	5	1

A blank column is filled with resistance tolerance codes (E: ±3%, J: ±5%).

Operating Temperature Range: -40°C to +150°C

If there is any additionally electrical characteristics, please contact from close sales office or website.

NTC Thermistors for Automotive

Chip Type 0603 (1608) Size (Meet AEC-Q200 rev.D)

2

Chip NTC Thermistors have Ni barrier termination, provide excellent solderability and offer high stability in environment due to unique inner construction.

Available Market is Automotive market where request the high reliability.

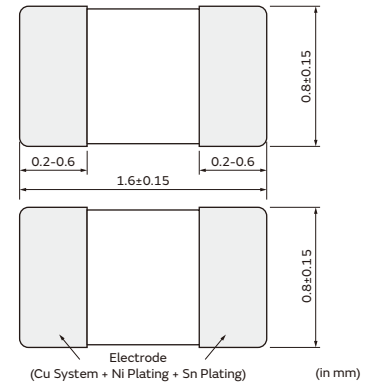

Features

1. Excellent solderability and high stability in environment
2. Excellent long time aging stability
3. High accuracy in resistance and B-constant
4. Flow/Reflow soldering possible
5. Lead is not contained in the product
6. NCU series are recognized by UL/cUL.
(UL1434, File No.E137188)

Detailed are accessible from the following URL.
<https://www.murata.com/en-global/products/thermistor/ntc/ncu>

Applications

1. Car audio, car navigation
2. Various engine control units
3. Circuits for ETC equipment
4. Various motor driving circuits
5. Temperature compensation for various circuits

Part Number	Resistance (25°C) (ohm)	B-Constant (25-50°C) (K)	B-Constant (25-80°C) (Reference Value) (K)	B-Constant (25-85°C) (Reference Value) (K)	B-Constant (25-100°C) (Reference Value) (K)	Maximum Operating Current (25°C) (mA)	Maximum Voltage (V)	Typical Dissipation Constant (25°C) (mW/°C)
NCU18XH103D6SRB	10k ±0.5%	3380 ±0.7%	3428	3434	3455	0.100	5	1
NCU18XH103F6SRB	10k ±1%	3380 ±1%	3428	3434	3455	0.100	5	1
NCU18XH103□6SRB	10k	3380 ±1%	3428	3434	3455	0.100	5	1
NCU18WB473D6SRB	47k ±0.5%	4050 ±0.5%	4101	4108	4131	0.046	5	1
NCU18WB473F6SRB	47k ±1%	4050 ±1%	4101	4108	4131	0.046	5	1
NCU18WB473□6SRB	47k	4050 ±1%	4101	4108	4131	0.046	5	1
NCU18WF104D6SRB	100k ±0.5%	4250 ±0.5%	4303	4311	4334	0.032	5	1
NCU18WF104F6SRB	100k ±1%	4250 ±1%	4303	4311	4334	0.032	5	1
NCU18WF104□6SRB	100k	4250 ±2%	4303	4311	4334	0.032	5	1
NCU18WM154□6SRB	150k	4500 ± 3%	4571	4582	4614	0.026	5	1
NCU18WM224□6SRB	220k	4500 ± 3%	4571	4582	4614	0.021	5	1
NCU18WM474□6SRB	470k	4500 ± 3%	4571	4582	4614	0.015	5	1

A blank column is filled with resistance tolerance codes (E: ±3%, J: ±5%).

Operating Temperature Range: -40°C to +150°C

If there is any additionally electrical characteristics, please contact from close sales office or website.

NTC Thermistors for Automotive

Chip Type 0603 (1608) Size for Conductive Glue

NCG18, 0603 sized Chip NTC Thermistor enables conductive glue mounting.

Features

1. Excellent solderability and high stability in environment
2. Excellent long time aging stability
3. High accuracy in resistance and B-constant
4. Glue mounting possible
5. Lead is not contained in the product

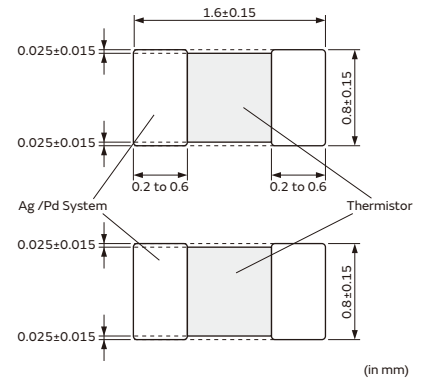

Applications

1. Various engine control units
2. ABS control unit
3. High power devices (IGBT)
4. Various circuits requiring low temperature mounting below solder melting point.
5. Temperature compensation for various circuits requiring high temperature.

Detailed are accessible from the following URL.
<https://www.murata.com/en-global/products/thermistor/ntc>

Part Number	Resistance (25°C) (ohm)	B-Constant (25-50°C) (K)	B-Constant (25-80°C) (Reference Value) (K)	B-Constant (25-85°C) (Reference Value) (K)	B-Constant (25-100°C) (Reference Value) (K)	Maximum Operating Current (25°C) (mA)	Maximum Voltage (V)	Typical Dissipation Constant (25°C) (mW/°C)
NCG18XH103F0SRB	10k ±1%	3380 ±1%	3428	3434	3455	0.100	5	1
NCG18WF104F0SRB	100k ±1%	4200 ±1%	4255	4260	4282	0.032	5	1

Operating Temperature Range: -55°C to +150°C

NTC Thermistors Chip Type Standard Land Pattern Dimensions

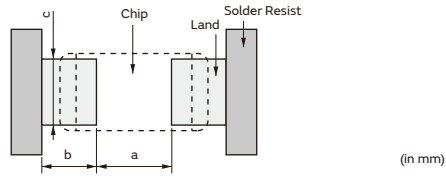

Part Number	Mounting Methods	Dimensions (mm)			
		Chip (L x W)	a	b	c
NCU15	Reflow Soldering	1.0 x 0.5	0.6	0.4-0.5	0.5
NCU18	Flow Soldering	1.6 x 0.8	0.6-1.2	0.8-0.9	0.6-0.8
	Reflow Soldering		0.6-1.2	0.6-0.7	0.6-0.8
NCG18	Conductive Glue	1.6 x 0.8	0.6	0.6	1.0

NTC Thermistors Chip Type Temperature Characteristics (Center Value)

Part Number	NCU□□XH103D	NCU□□XH103	NCU□□WB473D	NCU□□WB473	NCU□□WF104D	NCU□□WF104	NCU□□WM154	NCU□□WM224
Resistance	10kΩ±0.5%	10kΩ	47kΩ±0.5%	47kΩ	100kΩ±0.5%	100ΩW	150kΩ	220kΩ
B-Constant	3380K±0.7%	3380K	4050K±0.5%	4050K	4250K±0.5%	4250K	4500K	4500K
Temp. (°C)	Resistance (kΩ)	Resistance (kΩ)	Resistance (kΩ)	Resistance (kΩ)	Resistance (kΩ)	Resistance (kΩ)	Resistance (kΩ)	Resistance (kΩ)
-40	197.390	195.652	1690.586	1747.920	4221.283	4397.119	7899.466	11585.884
-35	149.390	148.171	1215.318	1245.428	2995.044	3088.599	5466.118	8016.973
-30	114.340	113.347	882.908	898.485	2146.996	2197.225	3834.499	5623.931
-25	88.381	87.559	647.911	655.802	1554.599	1581.881	2720.523	3990.100
-20	68.915	68.237	480.069	483.954	1136.690	1151.037	1951.216	2861.784
-15	54.166	53.650	359.009	360.850	839.019	846.579	1415.565	2076.162
-10	42.889	42.506	270.868	271.697	624.987	628.988	1036.984	1520.909
-5	34.196	33.892	206.113	206.463	469.678	471.632	767.079	1125.049
0	27.445	27.219	158.126	158.214	355.975	357.012	572.667	839.912
5	22.165	22.021	122.267	122.259	272.011	272.500	431.264	632.521
10	18.010	17.926	95.256	95.227	209.489	209.710	327.405	480.194
15	14.720	14.674	74.754	74.730	162.559	162.651	250.538	367.455
20	12.099	12.081	59.075	59.065	127.057	127.080	193.166	283.310
25	10.000	10.000	47.000	47.000	100.000	100.000	150.000	220.000
30	8.309	8.315	37.636	37.643	79.222	79.222	117.281	172.012
35	6.939	6.948	30.326	30.334	63.167	63.167	92.293	135.364
40	5.824	5.834	24.583	24.591	50.677	50.677	73.090	107.198
45	4.911	4.917	20.043	20.048	40.904	40.904	58.240	85.419
50	4.160	4.161	16.433	16.433	33.195	33.195	46.665	68.441
55	3.539	3.535	13.545	13.539	27.091	27.091	37.605	55.153
60	3.024	3.014	11.223	11.209	22.224	22.224	30.453	44.665
65	2.593	2.586	9.345	9.328	18.323	18.323	24.804	36.379
70	2.233	2.228	7.818	7.798	15.184	15.184	20.293	29.763
75	1.929	1.925	6.571	6.544	12.635	12.635	16.679	24.462
80	1.673	1.669	5.548	5.518	10.566	10.566	13.776	20.205
85	1.455	1.452	4.704	4.674	8.873	8.873	11.428	16.761
90	1.270	1.268	4.004	3.972	7.481	7.481	9.520	13.962
95	1.112	1.110	3.422	3.388	6.337	6.337	7.966	11.684
100	0.976	0.974	2.936	2.902	5.384	5.384	6.688	9.809
105	0.860	0.858	2.528	2.494	4.594	4.594	5.639	8.270
110	0.759	0.758	2.184	2.150	3.934	3.934	4.772	6.998
115	0.673	0.672	1.893	1.860	3.380	3.380	4.052	5.942
120	0.598	0.596	1.646	1.615	2.916	2.916	3.454	5.067
125	0.532	0.531	1.436	1.406	2.522	2.522	2.955	4.334
130	0.476	0.474	1.256	1.227	2.190	2.190	2.536	3.719
135	0.426	0.424	1.102	1.075	1.907	1.907	2.182	3.200
140	0.383	0.381	0.969	0.945	1.665	1.665	1.884	2.763
145	0.344	0.342	0.854	0.831	1.459	1.459	1.632	2.394
150	0.311	0.309	0.755	0.735	1.282	1.282	1.418	2.079

Continued on the following page. ↗

NTC Thermistors Chip Type Temperature Characteristics (Center Value)

Continued from the preceding page. ↘

For Conductive Glue

Part Number	NCU□□WM474
Resistance	470kΩ
B-Constant	4500K
Temp. (°C)	Resistance (kΩ)
-40	24751.661
-35	17127.169
-30	12014.762
-25	8524.305
-20	6113.811
-15	4435.437
-10	3249.216
-5	2403.515
0	1794.358
5	1351.294
10	1025.870
15	785.018
20	605.252
25	470.000
30	367.480
35	289.186
40	229.014
45	182.485
50	146.215
55	117.828
60	95.420
65	77.718
70	63.584
75	52.260
80	43.166
85	35.808
90	29.828
95	24.961
100	20.955
105	17.668
110	14.951
115	12.695
120	10.824
125	9.259
130	7.945
135	6.837
140	5.904
145	5.113
150	4.442

Part Number	NCG18XH103	NCG18WF104
Resistance	10ΩW	100ΩW
B-Constant	3380K	4200K
Temp. (°C)	Resistance (kΩ)	Resistance (kΩ)
-55	481.258	13019.2917
-50	352.304	8807.8909
-45	261.060	6042.9955
-40	195.661	4205.6861
-35	148.177	2966.4355
-30	113.351	2118.7894
-25	87.562	1531.3193
-20	68.239	1118.4222
-15	53.651	825.5695
-10	42.507	615.5264
-5	33.893	463.1041
0	27.219	351.7064
5	22.021	269.3046
10	17.926	207.8907
15	14.674	161.7224
20	12.081	126.7225
25	10.000	100.0000
30	8.315	79.4390
35	6.948	63.5094
40	5.834	51.0835
45	4.917	41.3360
50	4.161	33.6281
55	3.535	27.5103
60	3.014	22.6211
65	2.586	18.6920
70	2.228	15.5246
75	1.925	12.9466
80	1.669	10.8488
85	1.452	9.1290
90	1.268	7.7128
95	1.110	6.5455
100	0.974	5.5722
105	0.858	4.7638
110	0.758	4.0868
115	0.672	3.5178
120	0.596	3.0403
125	0.531	2.6336
130	0.474	2.2902
135	0.424	1.9976
140	0.381	1.7475
145	0.342	1.5332
150	0.309	1.3491

NTC Thermistors Chip Type Specifications and Test Methods

NCU Series (For AEC-Q200 rev.D)

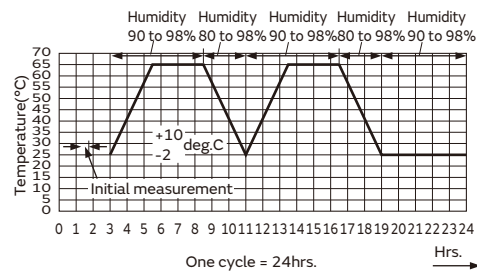
No.	AEC-Q200 Test Item	Specifications	AEC-Q200 Test Methods															
1	Pre-and Post-Stress Electrical Test	-	-															
2	High Temperature Exposure (Storage)	(*1) · Resistance(R25) change should be less than ±5%. · B-constant(B25/50) change should be less than ±2%. · No visible damage.	Leave continuously according to the following table for 1000hrs. <table border="1"> <tr> <td>Operating Temp. Range: -40 to +150°C Type</td> <td>150±3°C</td> </tr> <tr> <td>Operating Temp. Range: -40 to +125°C Type</td> <td>125±3°C</td> </tr> </table> Measurement at 24±2hrs. after test condition.	Operating Temp. Range: -40 to +150°C Type	150±3°C	Operating Temp. Range: -40 to +125°C Type	125±3°C											
Operating Temp. Range: -40 to +150°C Type	150±3°C																	
Operating Temp. Range: -40 to +125°C Type	125±3°C																	
3	Temperature Cycling	· Resistance(R25) change should be less than ±5%. · B-constant(B25/50) change should be less than ±2%. · No visible damage.	Perform 1000 cycles according to the four heat treatments listed in the following table. <table border="1"> <thead> <tr> <th>Step</th> <th>1</th> <th>2</th> <th>3</th> <th>4</th> </tr> </thead> <tbody> <tr> <td>Temp. (deg.C)</td> <td>-55+0/-3</td> <td>Room Temp.</td> <td>125+3/-0</td> <td>Room Temp.</td> </tr> <tr> <td>Time (min.)</td> <td>15±3</td> <td>1</td> <td>15±3</td> <td>1</td> </tr> </tbody> </table> Measurement at 24±2hrs. after test condition.	Step	1	2	3	4	Temp. (deg.C)	-55+0/-3	Room Temp.	125+3/-0	Room Temp.	Time (min.)	15±3	1	15±3	1
Step	1	2	3	4														
Temp. (deg.C)	-55+0/-3	Room Temp.	125+3/-0	Room Temp.														
Time (min.)	15±3	1	15±3	1														
4	Moisture Resistance	· Resistance(R25) change should be less than ±5%. · B-constant(B25/50) change should be less than ±2%. · No visible damage.	Apply the 24-hrs. heat (25 to 65 °C) and humidity (80 to 98%) treatment shown below, 10 consecutive times.  Measurement at 24±2hrs. after test condition.															
5	Biased Humidity	(*2) · Resistance(R25) change should be less than ±10%. · B-constant(B25/50) change should be less than ±2%. · No visible damage.	85±2 °C, 85%RH in air for 1000hrs. with Permissive Operating Current. Measurement at 24±2hrs. after test condition.															
6	Operational Life	· Resistance(R25) change should be less than ±5%. · B-constant(B25/50) change should be less than ±2%. · No visible damage.	85±3 °C in air for 1000hrs. with Permissive Operating Current. Measurement at 24±2hrs. after test condition.															
7	External Visual	No defects of abnormalities.	Visual Inspection.															
8	Physical Dimension	Within the specified dimensions.	Using calipers.															
9	Terminal Strength (Leaded)	N/A																
10	Resistance to Solvents	· Resistance(R25) change should be less than ±5%. · B-constant(B25/50) change should be less than ±2%. · No visible damage.	Per MIL-STD-202 Method 215 Solvent 1: 1 part (by volume) of isopropyl alcohol 3 parts (by volume) of mineral spirits.															
11	Mechanical Shock	· Resistance(R25) change should be less than ±5%. · B-constant(B25/50) change should be less than ±2%. · No visible damage.	Per MIL-STD-202 Method 213 Test Condition F 1500g's, 0.5ms, In 3 directions perpendicularly intersecting each other (total 18 times).															
12	Vibration	(*1) · Resistance(R25) change should be less than ±5%. · B-constant(B25/50) change should be less than ±2%. · No visible damage.	Simple harmonic motion between 10Hz to 2.0k Hz and back to 10 Hz of max. amplitude 1.5mm for 20min. This motion should be applied 12 times in each of 3 mutually perpendicular directions (total of 36 times).															
13	Resistance to Soldering Heat	(*1) · Resistance(R25) change should be less than ±5%. · B-constant(B25/50) change should be less than ±2%. · No visible damage.	Per MIL-STD-202 Method 210 Test Condition B, 260 °C for 10 +/-1sec.															

· The Test Condition specification (*1,*2) is applied to the follow P/N.

P/N: NCU15XH103□□SR□, NCU15WB473□□SR□, NCU15WF104□□SR□, NCU18XH103□□SR□

(*1) Resistance(R25) change should be less than 1%
 B-constant(B25/50) change should be less than 1%

(*2) Resistance(R25) change should be less than 5%
 B-constant(B25/50) change should be less than 1%

Continued on the following page. ↗

NTC Thermistors Chip Type Specifications and Test Methods

Continued from the preceding page. ↘

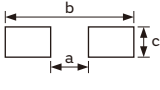
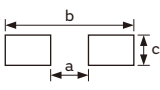
No.	AEC-Q200 Test Item	Specifications	AEC-Q200 Test Methods												
14	Thermal Shock	<ul style="list-style-type: none"> Resistance(R₂₅) change should be less than ±5%. B-constant(B_{25/50}) change should be less than ±2%. No visible damage. 	Perform 300 cycles according to the two heat treatments listed in the following table. (Maximum transfer time is 20sec.) <table border="1"> <thead> <tr> <th>Step</th> <th>1</th> <th>2</th> </tr> </thead> <tbody> <tr> <td>Temp. (°C)</td> <td>-55+0/-3</td> <td>125+3/-0</td> </tr> <tr> <td>Time (min.)</td> <td>15±3</td> <td>15±3</td> </tr> </tbody> </table> Measurement at 24±2hrs. after test condition.	Step	1	2	Temp. (°C)	-55+0/-3	125+3/-0	Time (min.)	15±3	15±3			
Step	1	2													
Temp. (°C)	-55+0/-3	125+3/-0													
Time (min.)	15±3	15±3													
15	ESD	<ul style="list-style-type: none"> Resistance(R₂₅) change should be less than ±5%. B-constant(B_{25/50}) change should be less than ±2%. No visible damage. 	Per AEC-Q200-002												
16	Solderability	Minimum 95% of the whole electrode surface should be covered with solder.	Per J-STD-002 SMD b) Method B @ 215 °C category 3.												
17	Electrical Characterization	Within the specified tolerance.	Resistance at 25 °C. B-constant (B ₂₅₋₅₀)												
18	Flammability	N/A													
19	Board Flex	(*1) <ul style="list-style-type: none"> Resistance(R₂₅) change should be less than ±5%. B-constant(B_{25/50}) change should be less than ±2%. No visible damage. 	Per AEC-Q200-005 Bend the board 2.0mm for 60sec. Use the follow land size. <table border="1"> <thead> <tr> <th>Type</th> <th>a</th> <th>b</th> <th>c</th> </tr> </thead> <tbody> <tr> <td>NCU15_SRC</td> <td>0.6</td> <td>1.4</td> <td>0.5</td> </tr> <tr> <td>NCU18_SRB</td> <td>1.2</td> <td>2.4</td> <td>0.6</td> </tr> </tbody> </table> (in mm) 	Type	a	b	c	NCU15_SRC	0.6	1.4	0.5	NCU18_SRB	1.2	2.4	0.6
Type	a	b	c												
NCU15_SRC	0.6	1.4	0.5												
NCU18_SRB	1.2	2.4	0.6												
20	Terminal Strength (SMD)	(*1) <ul style="list-style-type: none"> Resistance(R₂₅) change should be less than ±5%. B-constant(B_{25/50}) change should be less than ±2%. No visible damage. 	Per AEC-Q200-006 Apply a *17.7N force to the side of device for 60sec. Use follow land size. *4.9N (NCP15_SRC) <table border="1"> <thead> <tr> <th>Type</th> <th>a</th> <th>b</th> <th>c</th> </tr> </thead> <tbody> <tr> <td>NCU15_SRC</td> <td>0.4</td> <td>1.5</td> <td>0.5</td> </tr> <tr> <td>NCU18_SRB</td> <td>1.0</td> <td>3.0</td> <td>1.2</td> </tr> </tbody> </table> (in mm) 	Type	a	b	c	NCU15_SRC	0.4	1.5	0.5	NCU18_SRB	1.0	3.0	1.2
Type	a	b	c												
NCU15_SRC	0.4	1.5	0.5												
NCU18_SRB	1.0	3.0	1.2												

• The Test Condition specification (*1,*2) is applied to the follow P/N.

P/N: NCU15XH103□□SR□, NCU15WB473□□SR□, NCU15WF104□□SR□, NCU18XH103□□SR□

- (*1) Resistance(R₂₅) change should be less than 1%
 B-constant(B_{25/50}) change should be less than 1%
- (*2) Resistance(R₂₅) change should be less than 5%
 B-constant(B_{25/50}) change should be less than 1%

NTC Thermistors Chip Type Specifications and Test Methods

NCG18 Series (For Conductive Glue)

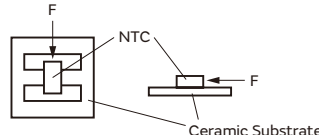
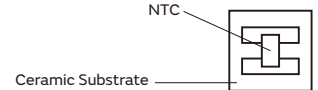
No.	Item	Rating value	Method of Examination						
1	Dry Heat	<ul style="list-style-type: none"> Resistance (R₂₅) change should be less than ±3% B-constant (B₂₅₋₅₀) change should be less than ±1% No visible damage. 	150±3°C in air, for 1000 +48/-0hrs. without loading.						
2	Cold	<ul style="list-style-type: none"> Resistance (R₂₅) change should be less than ±1% B-constant (B₂₅₋₅₀) change should be less than ±1% No visible damage. 	-40±3°C in air, for 1000 +48/-0hrs. without loading.						
3	Damp Heat	<ul style="list-style-type: none"> Resistance (R₂₅) change should be less than ±3% B-constant (B₂₅₋₅₀) change should be less than ±1% No visible damage. 	60±2°C, 90 to 95%RH in air, for 1000 +48/-0hrs. without loading.						
4	High Temperature Load		150±3°C in air, with Permissive Operating Current (D.C. 0.31mA) for 1000 +48/-0hrs.						
5	High Temperature Humidity Load		85±2°C, 85%RH in air, with Permissive Operating Current (D.C. 0.31mA) for 1000 +48/-0hrs.						
6	Thermal Shock		1000 cycles of the following sequence without loading.						
			<table border="1"> <thead> <tr> <th>Step</th> <th>Temp. (°C)</th> <th>Time (min.)</th> </tr> </thead> <tbody> <tr> <td>1</td> <td>-55+0/-3</td> <td>15</td> </tr> <tr> <td>2</td> <td>+150+3/-0</td> <td>15</td> </tr> </tbody> </table>	Step	Temp. (°C)	Time (min.)	1	-55+0/-3	15
Step	Temp. (°C)	Time (min.)							
1	-55+0/-3	15							
2	+150+3/-0	15							
7	Robustness of Electrode	<ul style="list-style-type: none"> No peeling of the electrodes. 	Mount NTC Thermistor with conductive glue on Ceramic substrate, and apply 4.90N of force as shown below: 						
8	Vibration Resistant	<ul style="list-style-type: none"> Resistance (R₂₅) change should be less than ±1% B-constant (B₂₅₋₅₀) change should be less than ±1% No visible damage. 	Solder NTC Thermistor on the glass epoxy PCB as shown below. Frequency: 10Hz to 2000Hz to 10Hz (20min.) Max. amplitude: 3.0mm Vibrated for a period of 4hrs. in three (3) directions perpendicularly intersecting each other (for total of 12hrs.). 						

- NTC Thermistor should be mounted on the Ceramic substrate with "Standard Land Dimensions" by our recommendable conductive glue (PC3000: Manufactured by Heraeus) and be tested. Thickness of the conductive glue screening should be 50µm.
- R₂₅ means the zero-power resistance at 25°C.
- B₂₅₋₅₀ is calculated by the zero-power resistances of NTC Thermistor at 25°C and at 50°C.
- After each test, NTC Thermistor should be kept for 1hr. at room temperature (normal humidity and normal atmospheric pressure). Then the resistances (R₂₅ and R₅₀) should be measured and the appearance should be visually examined.
- In the case that of R₂₅ or B₂₅₋₅₀ changes are greater than the specified value due to the method of mounting with conductive glue, these specifications should be judged by an evaluation with the chip only (not mounting).

NTC Thermistors Chip Type ⚠Caution/Notice

⚠Caution (Storage and Operating Conditions)

This product is designed for application in an ordinary environment (normal room temperature, humidity and atmospheric pressure).

Do not use under the following conditions because all of these factors can deteriorate the product characteristics or cause failures and burn-out.

1. Corrosive gas or deoxidizing gas
(Chlorine gas, Hydrogen sulfide gas, Ammonia gas, Sulfuric acid gas, Nitric oxide gas, etc.)

2. Volatile or flammable gas
3. Dusty conditions
4. Under vacuum, or under high or low pressure
5. Wet or humid locations
6. Places with salt water, oils, chemical liquids or organic solvents
7. Strong vibrations
8. Other places where similar hazardous conditions exist

⚠Caution (Other)

Be sure to provide an appropriate fail-safe function on your product to prevent secondary damages that may be caused by the abnormal function or the failure of our product.

Notice (Storage and Operating Conditions)

To keep the mounting nature of product from declining, the following storage conditions are recommended.

1. Storage condition:
Temperature -10 to +40°C
Humidity less than 75%RH (not dewing condition)
2. Storage term:
Use this product within 6 months after delivery by first-in and first-out stocking system.
3. Storage place:
Do not store this product in corrosive gas (Sulfuric acid gas, Chlorine gas, etc.) or in direct sunlight.

Notice (Rating)

Use this product within the specified temperature range.

Higher temperature may cause deterioration of the characteristics or the material quality of this product.

NTC Thermistors Chip Type ⚠️Caution/Notice

Notice (Soldering and Mounting) NCU15/18 Series

1. Mounting Position

Choose a mounting position that minimizes the stress imposed on the chip during flexing or bending of the board.

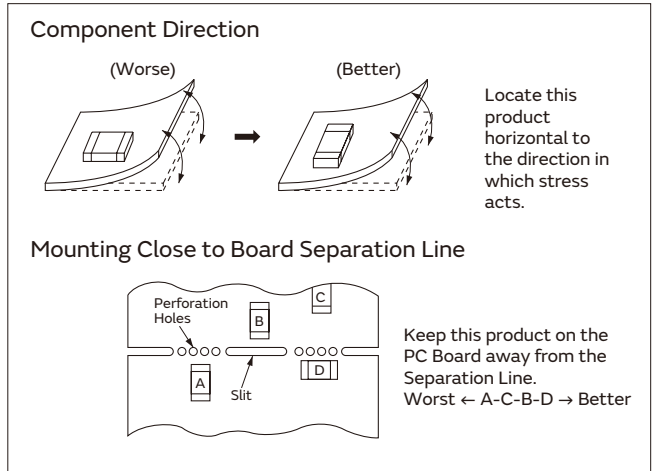

2. Allowable Soldering Temperature and Time

- Solder within the temperature and time combinations, indicated by the slanted lines in the following graphs.
- Excessive soldering conditions may cause dissolution of metalization or deterioration of solder-wetting on the external electrode.
- In the case of repeated soldering, the accumulated soldering time should be within the range shown in the following figures. (For example, Reflow peak temperature: 260°C, twice -> The total accumulated soldering time at 260°C is within 30sec.)

NCU15 Series

Allowable Reflow Soldering Temp. and Time

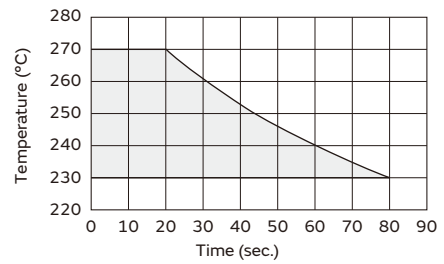

NCU18 Series

Allowable Flow Soldering Temp. and Time

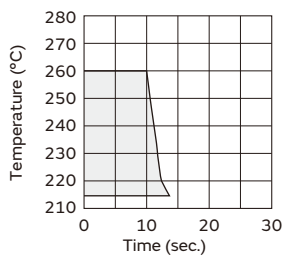

Allowable Reflow Soldering Temp. and Time

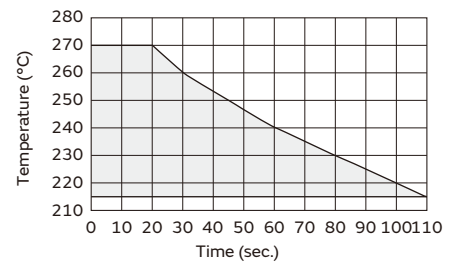

Continued on the following page. ↗

NTC Thermistors Chip Type ⚠Caution/Notice

Continued from the preceding page. ↘

3. Recommendable Temperature Profile for Soldering
- (a) Insufficient preheating may cause a crack on the ceramic body. The difference between preheating temperature and maximum temperature in the profile shall be 100 °C.
- (b) Rapid cooling by dipping in solvent or by other means is not recommended.

* In the case of repeated soldering, the accumulated soldering time should be within the range shown in "2. Allowable Soldering Temperature and Time."

NCU15 Series

Reflow Soldering Conditions

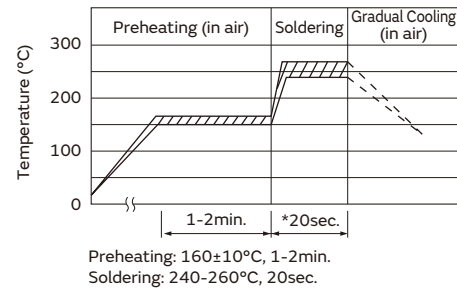

NCU18 Series

Flow Soldering Conditions

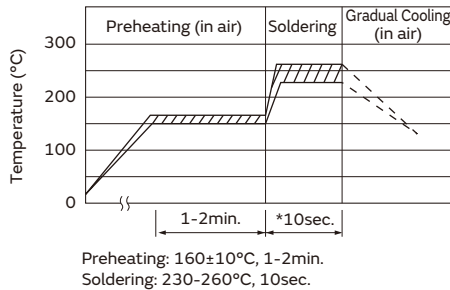

Reflow Soldering Conditions

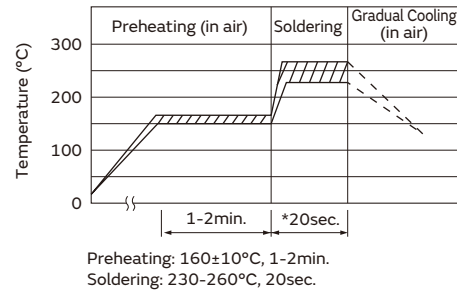

4. Solder and Flux

(1) Solder and Paste

(a) Reflow Soldering: NCU15/NCU18 Series

For your reference, we are using the solder paste below for any internal tests of this product.

- M705-GRM360-K2-V
 (Sn:Ag:Cu=96.5wt%:3.0wt%:0.5wt%)
 (Manufactured by Senju Metal Industry Co., Ltd.)

(b) Flow Soldering: NCU18 Series

We are using the following solder paste for any internal tests of this product.

- Sn:Ag:Cu=96.5wt%:3.0wt%:0.5wt%

(2) Flux

Use rosin type flux in the soldering process.

If the flux below is used, some problems might be caused in the product characteristics and reliability. Please do not use these types of flux.

- Strong acidic flux (with halide content exceeding 0.1wt%).
- Water-soluble flux
 (*Water-soluble flux can be defined as non-rosin type flux including wash-type flux and non-wash-type flux.)

5. Cleaning Conditions

For removing the flux after soldering, observe the following points in order to avoid deterioration of the characteristics or any change of the external electrodes' quality.

- Please keep mounted parts and the substrate from an occurrence of resonance in ultrasonic cleaning.
- Please do not clean the products in the case of using a non-washed type flux.

	NCU15	NCU18
Solvent	Isopropyl Alcohol	Isopropyl Alcohol
Dipping Cleaning	Less than 5min. at room temp. or less than 2min. at 40°C max.	Less than 5min. at room temp. or less than 2min. at 40°C max.
Ultrasonic Cleaning	Less than 5min. 20W/ℓ Frequency of 28 to 40kHz.	Less than 1min. 20W/ℓ Frequency of several 10 to 100kHz.
Drying	After cleaning, promptly dry this product.	

Continued on the following page. ↗

NTC Thermistors Chip Type ⚠️Caution/Notice

Continued from the preceding page. ↘

6. Printing Conditions of Solder Paste

- The amount of solder is critical. Standard height of fillet is shown in the table below.
- Too much soldering may cause mechanical stress, resulting in cracking, mechanical and/or electronic damage.

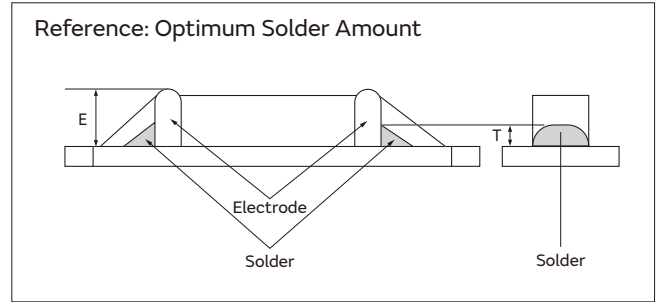

Part Number	The Solder Paste Thickness	T
NCU15	150μm	$1/3E \leq T \leq E$
NCU18	200μm	$0.2\text{mm} \leq T \leq E$

7. Adhesive Application and Curing

- Thin or insufficient adhesive may result in loose component contact with land during flow soldering.
- Low viscosity adhesive causes chips to slip after mounting.

Notice (Mounting) NCG18 Series

In your mounting process, observe the following points in order to avoid deterioration of the characteristics or destruction of this product. The mounting quality of this product may also be affected by the mounting conditions, shown in the points below.

1. Recommendable Land Size

Too small a land size parameter 'a' may cause an electric short mode of this product by conductive glue expanding on the surface of this product on mounting.

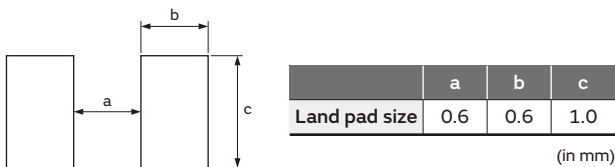

2. Recommendable Conductive Glue

- PC3000 (Manufactured by Heraeus)

3. Screening Conditions of Conductive glue

(1) Recommendable Screening Size

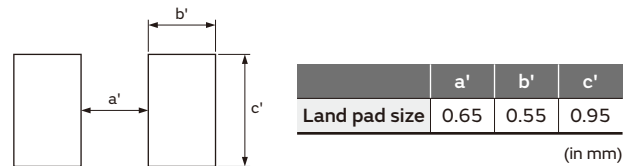

(2) Recommendable thickness of conductive glue screening shall be 50μm.

(3) Too much conductive glue gives an electric short mode of this product by conductive glue expanding on the surface of this product on mounting.

4. There is a possibility of unexpected failure in your mounting process, caused by mounting conditions. Please evaluate whether this product is correctly mounted under your mounting conditions.

Notice (Handling)

The ceramic of this product is fragile, and care must be taken not to load an excessive press-force or to give a shock at handling. Such forces may cause cracking or chipping.

NTC Thermistors for Automotive

Thermo String Cooper Wire Type for Temperature Sensor

This product is a small flexible lead type NTC Thermistor with a small head and a thin lead wire.

Features

1. High accuracy and high sensibility temperature sensing is available in a small and highly accurate NTC Thermistor.
2. Narrow space temperature sensing is available from the small sensing head and the thin lead wire.
3. Flexibility and a wide variety of lengths (60 mm to 150mm) enables the design of flexible temperature sensing architectures.
4. This product is compatible with our 0402 (EIA) size chip Thermistor.
5. Excellent long-time aging stability
6. This is a halogen-free product.*
 * Cl= max.900ppm,
 Br=max.900ppm and Cl+Br=max.1500ppm
7. Lead is not contained in the product.

Applications

1. Car audio, car navigation
2. Various engine control units
3. Circuits for ETC equipment
4. Various motor driving circuits
5. Temperature compensation for various circuits

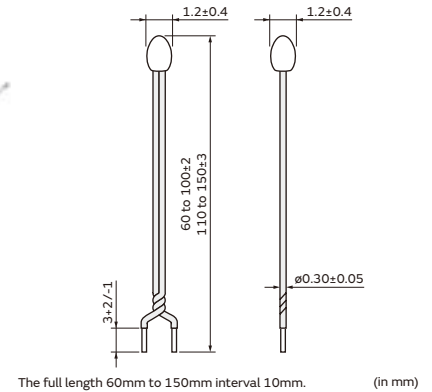

NXFS15_1B Type (twist)

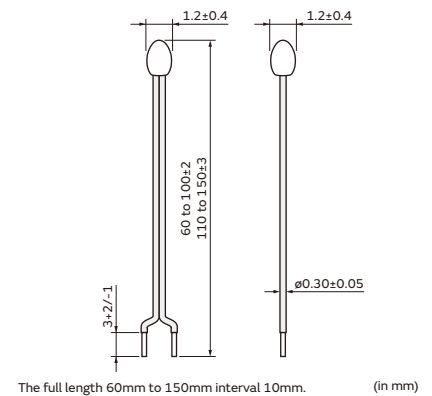

NXFS15_2B Type (without twist)

Detailed are accessible from the following URL.
<https://www.murata.com/en-global/products/thermistor/ntc/nxf>

Part Number	Resistance (25°C) (ohm)	B-Constant (25-50°C) (K)	B-Constant (25-80°C) (Reference Value) (K)	B-Constant (25-85°C) (Reference Value) (K)	B-Constant (25-100°C) (Reference Value) (K)	Maximum Operating Current (25°C) (mA)	Rated Electric Power (25°C) (mW)	Typical Dissipation Constant (25°C) (mW/°C)	Thermal Time Constant (25°C) (s)
NXFS15XM202EA□B□□□□	2k±3%	3500±1%	3539	3545	3560	0.27	7.5	1.5	4
NXFS15XV302FA□B□□□□	3k±1%	3936±1%	3971	3977	3989	0.22	7.5	1.5	4
NXFS15XH103FA□B□□□□	10k±1%	3380±1%	3428	3434	3455	0.12	7.5	1.5	4
NXFS15XV103FA□B□□□□	10k±1%	3936±1%	3971	3977	3989	0.12	7.5	1.5	4
NXFS15WB473FA□B□□□□	47k±1%	4050±1%	4101	4108	4131	0.06	7.5	1.5	4
NXFS15WF104FA□B□□□□	100k±1%	4250±1%	4303	4311	4334	0.04	7.5	1.5	4

□ is filled with lead shape (1: twist, 2: without twist).
 □□□□ is filled with total-length codes. (60-150mm interval 10mm, ex. 060=60mm)
 Maximum Operating Current raises Thermistor's temperature by 0.1°C.
 Rated Electric Power is necessary electric power for Thermistor's temperature to rise 5°C by self heating at 25°C in still air.
 Operating Temperature Range: -40°C to +125°C

NTC Thermistors for Automotive

Thermo String Nickel Copper Wire Type for Temperature Sensor

This product is a small flexible lead type NTC Thermistor with a small head and a thin lead wire.

Features

1. High accuracy and high sensibility temperature sensing is available in a small and highly accurate NTC Thermistor.
 Nickel Copper Wire Type has high thermal response than the Cooper Wire Type.
2. Narrow space temperature sensing is available from the small sensing head and the thin lead wire.
3. Flexibility and a wide variety of lengths (21 mm to 50mm) enables the design of flexible temperature sensing architectures.
4. This product is compatible with our 0402 (EIA) size chip Thermistor.
5. Excellent long-time aging stability
6. This is a halogen-free product.*
 * Cl= max.900ppm,
 Br=max.900ppm and Cl+Br=max.1500ppm
7. Lead is not contained in the product.

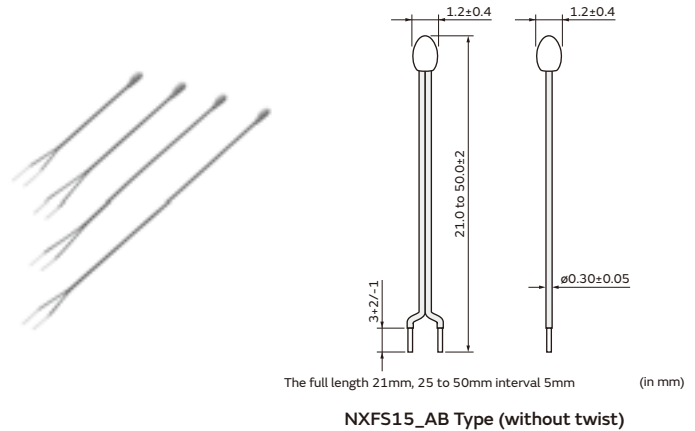

Detailed are accessible from the following URL.
<https://www.murata.com/en-global/products/thermistor/ntc/nxf>

Applications

1. Car audio, car navigation
2. Various engine control units
3. Circuits for ETC equipment
4. Various motor driving circuits
5. Temperature compensation for various circuits

Part Number	Resistance (25°C) (ohm)	B-Constant (25-50°C) (K)	B-Constant (25-80°C) (Reference Value) (K)	B-Constant (25-85°C) (Reference Value) (K)	B-Constant (25-100°C) (Reference Value) (K)	Maximum Operating Current (25°C) (mA)	Rated Electric Power (25°C) (mW)	Typical Dissipation Constant (25°C) (mW/°C)	Thermal Time Constant (25°C) (s)
NXFS15XM202EEAB□□□	2k±3%	3500±1%	3539	3545	3560	0.17	3	0.6	3
NXFS15XV302FEAB□□□	3k±1%	3936±1%	3971	3977	3989	0.14	3	0.6	3
NXFS15XV502FEAB□□□	5k±1%	3936±1%	3971	3977	3989	0.11	3	0.6	3
NXFS15XH103FEAB□□□	10k±1%	3380±1%	3428	3434	3455	0.077	3	0.6	3
NXFS15XV103FEAB□□□	10k±1%	3936±1%	3971	3977	3989	0.077	3	0.6	3
NXFS15WB473FEAB□□□	47k±1%	4050±1%	4101	4108	4131	0.036	3	0.6	3
NXFS15WF104FEAB□□□	100k±1%	4250±1%	4303	4311	4334	0.024	3	0.6	3

□□□ is filled with total-length codes. (21, 25, 30, 35, 40, 45, 50mm, ex. 050=50mm)

Maximum Operating Current raises Thermistor's temperature by 0.1°C.

Rated Electric Power is necessary electric power for Thermistor's temperature to rise 5°C by self heating at 25°C in still air.

Operating Temperature Range: -40°C to +125°C

NTC Thermistors Thermo String Type Temperature Characteristics (Center Value)

Part Number	NXFS15XM202	NXFS15XV302	NXFS15XV502	NXFS15XH103	NXFS15XV103	NXFS15WB473	NXFS15WF104
Resistance	2.0kΩ	3.0kΩ	5.0kΩ	10kΩ	10kΩ	47kΩ	100kΩ
B-Constant	3500K	3936K	3936K	3380K	3936K	4050K	4250K
Temp. (°C)	Resistance (kΩ)	Resistance (kΩ)	Resistance (kΩ)	Resistance (kΩ)	Resistance (kΩ)	Resistance (kΩ)	Resistance (kΩ)
-40	44.981	101.251	168.752	195.652	337.503	1747.920	4397.119
-35	33.671	73.000	121.666	148.171	243.332	1245.428	3088.599
-30	25.444	53.249	88.748	113.347	177.496	898.485	2197.225
-25	19.417	39.258	65.430	87.559	130.859	655.802	1581.881
-20	14.955	29.228	48.714	68.237	97.428	483.954	1151.037
-15	11.619	21.969	36.615	53.650	73.230	360.850	846.579
-10	9.097	16.659	27.764	42.506	55.529	271.697	628.988
-5	7.178	12.740	21.233	33.892	42.467	206.463	471.632
0	5.707	9.824	16.374	27.219	32.747	158.214	357.012
5	4.568	7.635	12.725	22.021	25.450	122.259	272.500
10	3.682	5.980	9.966	17.926	19.932	95.227	209.710
15	2.986	4.718	7.864	14.674	15.727	74.730	162.651
20	2.437	3.749	6.249	12.081	12.498	59.065	127.080
25	2.000	3.000	5.000	10.000	10.000	47.000	100.000
30	1.651	2.416	4.027	8.315	8.054	37.643	79.222
35	1.370	1.959	3.264	6.948	6.529	30.334	63.167
40	1.143	1.597	2.662	5.834	5.324	24.591	50.677
45	0.958	1.310	2.183	4.917	4.366	20.048	40.904
50	0.807	1.080	1.801	4.161	3.601	16.433	33.195
55	0.682	0.896	1.493	3.535	2.985	13.539	27.091
60	0.580	0.746	1.244	3.014	2.488	11.209	22.224
65	0.495	0.625	1.041	2.586	2.083	9.328	18.323
70	0.424	0.526	0.876	2.228	1.752	7.798	15.184
75	0.365	0.444	0.740	1.925	1.480	6.544	12.635
80	0.315	0.377	0.628	1.669	1.256	5.518	10.566
85	0.273	0.321	0.535	1.452	1.070	4.674	8.873
90	0.237	0.275	0.458	1.268	0.916	3.972	7.481
95	0.207	0.236	0.394	1.110	0.787	3.388	6.337
100	0.181	0.204	0.340	0.974	0.679	2.902	5.384
105	0.160	0.177	0.294	0.858	0.588	2.494	4.594
110	0.141	0.154	0.256	0.758	0.512	2.150	3.934
115	0.124	0.134	0.223	0.672	0.446	1.860	3.380
120	0.110	0.117	0.195	0.596	0.391	1.615	2.916
125	0.098	0.103	0.172	0.531	0.343	1.406	2.522

NTC Thermistors Thermo String Type Specifications and Test Methods

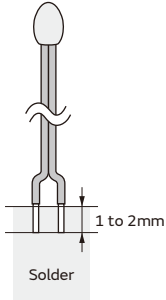
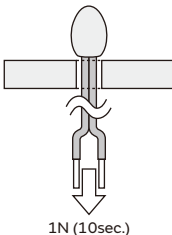
No.	Item	Specifications		Test Methods
1	High Temperature Storage Test	Except XM202&XV302	XM202&XV302	125±2°C in air, for 1000 +48/-0hrs. without loading.
		· Resistance (R25°C) fluctuation rate: less than ±1%. · B-Constant (B25/50°C) fluctuation rate: less than ±1%.	· Resistance (R25°C) fluctuation rate: less than ±3%. · B-Constant (B25/50°C) fluctuation rate: less than ±2%.	
2	Low Temperature Storage Test	· Resistance (R25°C) fluctuation rate: less than ±1%. · B-Constant (B25/50°C) fluctuation rate: less than ±1%.	· Resistance (R25°C) fluctuation rate: less than ±1%. · B-Constant (B25/50°C) fluctuation rate: less than ±1%.	-40 +0/-3°C in air, for 1000 +48/-0hrs. without loading.
3	Humidity Storage Test	· Resistance (R25°C) fluctuation rate: less than ±2%		85±2°C, 85%RH in air, for 1000 +48/-0hrs. without loading.
4	High Humidity Load Test	· B-Constant (B25/50°C) fluctuation rate: less than ±1%		85±2°C, 85%RH in air with 'Operating Current for Sensor,' for 1000 +48/-0hrs.
5	Thermal Shock	· Resistance (R25°C) fluctuation rate: less than ±3%. · B-Constant (B25/50°C) fluctuation rate: less than ±1%.	· Resistance (R25°C) fluctuation rate: less than ±3%. · B-Constant (B25/50°C) fluctuation rate: less than ±2%.	-55 +0/-3°C, 30min. in air +125 +3/-0°C, 30min. in air (1 cycle) Continuous 1000 cycles, without loading.
6	Insulation Break - down Voltage	· No damage electrical characteristics on DC100 V, 1min.		2mm length of coating resin from the top of Thermistor is to be dipped into beads of lead (Pb), and DC100V is applied to circuit between beads of lead (Pb) and lead wire for 1min.
7	Resistance to Soldering Heat	· Resistance (R25°C) fluctuation rate: less than ±1% · B-Constant (B25/50°C) fluctuation rate: less than ±1%		Both lead wires are dipped into 350±10°C solder for 3.5±0.5sec., or 260±5°C solder for 10±1sec. according to Fig-1  Fig-1
8	Solderability	· More than 90% of lead wire surface shall be covered by solder.		Both lead wires are dipped into flux (25wt% Colophony <JIS K 5902> isopropyl alcohol <JIS K 8839>) for 5 to 10sec. Then both lead wires are dipped into 245±5°C solder <Su-3.0Ag-0.5Cu> for 2±0.5sec. according to Fig-1.
9	Lead Wire Pull Strength	· Resistance (R25°C) fluctuation rate: less than ±1% · B-Constant (B25/50°C) fluctuation rate: less than ±1%		The lead wire shall be inserted in a ø1.0mm hole until resin part contacts with a substrate as shown in Fig-2. And 1N force for 10sec. shall be applied to the lead wire.  Fig-2

* · R25 is zero-power resistance at 25°C.
 · B25/50 is calculated by zero-power resistance of Thermistor in 25°C -50°C.
 · After each test, NTC Thermistor should be kept for 1hr. at room temperature (normal humidity and normal atmospheric pressure).

Continued on the following page. ↗

NTC Thermistors Thermo String Type Specifications and Test Methods

Continued from the preceding page. ↘

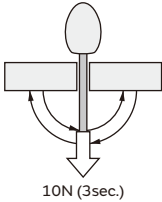
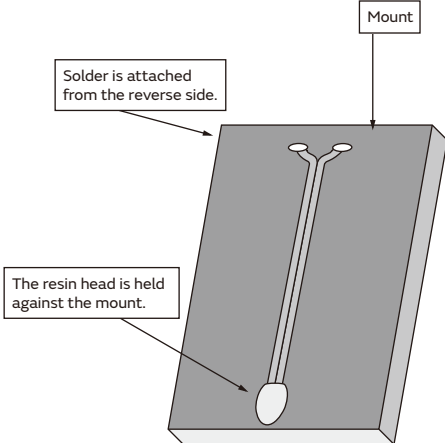
No.	Item	Specifications	Test Methods
10	Lead Wire Bending Strength	· Lead wire does not break.	<p>Hold the lead wires as in Fig-3. Bend by 90 degrees and again bend back to the initial position. Then bend to the other side by 90 degrees and again bend back to the initial position. After bending process, 10N force for 3sec. shall be applied to the lead wire.</p>  <p style="text-align: center;">10N (3sec.)</p> <p style="text-align: center;">Fig-3</p>
11	Free Fall		<p>NTC Thermistor shall be dropped without any force onto concrete floor from 1 meter height one time.</p>
12	Vibration	<ul style="list-style-type: none"> · Resistance (R25°C) fluctuation rate: less than ±1% · B-Constant (B25/50°C) fluctuation rate: less than ±1% · No visible damage at resin part. 	<p>NTC Thermistor shall be fixed to the vibration test equipment as shown below. Frequency: 10Hz to 2000Hz to 10Hz (20min.) Max. amplitude: 1.5mm Vibrated for a period of 2hrs. in three (3) directions perpendicularly intersecting each other (for total of 12hrs.)</p> 

* · R25 is zero-power resistance at 25°C.
 · B25/50 is calculated by zero-power resistance of Thermistor in 25°C -50°C.
 · After each test, NTC Thermistor should be kept for 1hr. at room temperature (normal humidity and normal atmospheric pressure).

NTC Thermistors Thermo String Type ⚠️Caution/Notice

⚠️Caution (Storage and Operating Conditions)

This product is designed for application in an ordinary environment (normal room temperature, humidity and atmospheric pressure).

Do not use under the following conditions because all of these factors can deteriorate the product characteristics or cause failures and burn-out.

1. Corrosive gas or deoxidizing gas
(Chlorine gas, Hydrogen sulfide gas, Ammonia gas, Sulfuric acid gas, Nitric oxide gas, etc.)

2. Volatile or flammable gas
3. Dusty conditions
4. Under vacuum, or under high or low pressure
5. Wet or humid locations
6. Places with salt water, oils, chemical liquids or organic solvents
7. Strong vibrations
8. Other places where similar hazardous conditions exist

⚠️Caution (Other)

Be sure to provide an appropriate fail-safe function on your product to prevent secondary damages that may be caused by the abnormal function or the failure of our product.

Notice (Storage and Operating Conditions)

To keep solderability of product from declining, the following storage conditions are recommended.

1. Storage condition:
Temperature -10 to +40°C
Humidity less than 75%RH (not dewing condition)
2. Storage term:
Use this product within 6 months after delivery by first-in and first-out stocking system.

3. Storage place:
Do not store this product in corrosive gas (Sulfuric acid gas, Chlorine gas, etc.) or in direct sunlight.

Notice (Rating)

Use this product within the specified temperature range.

Higher temperature may cause deterioration of the characteristics or the material quality of this product.

Notice (Soldering and Mounting)

Please note as shown below when you mount this product.

1. Do not melt solder in the resin head when you solder this product. If you do so, it has a possibility of wire break, electric short mode failure and wire coating break.
In case you cut the lead wire of this product less than 20mm from the resin head, the heat of the melted solder at the lead wire edge is propagated easily to the resin head along the lead wire.

2. Do not touch the resin head directly with the soldering iron. It may cause the melting of solder in the resin head.
3. Do not separate the parallel lead wires 10mm or less from the resin head, when you separate parallel lead wires.
4. If you mold this product by resin, please evaluate the quality of this product before you use it.
5. Do not bend the lead wire radius 1mm or less when you bend the lead wire.

Notice (Handling)

The ceramic of this product is fragile, and care must be taken not to load an excessive press-force or to give a shock at handling.

Such forces may cause cracking or chipping.

NTC Thermistors for Automotive

Temperature Sensor Lead Type

This thermistor is for normal temperature level sensors having self-subsistence due to strong lead strength based on chip NTC.

Features

1. This highly accurate NTC Thermistor provides extremely precise temperature sensing.
2. This product is compatible with 1005 (1.0mm x 0.5mm) size NTC Thermistor.
3. The variation per hour of this product is highly stable.
4. This product is produced with an automation line that was consistent from lead to packaging so that a product of uniform quality may be obtained at low cost in large quantities.
5. Since this product has strong lead intensity with original lead mounting technique, it is bent at the time of use and can withstand processing, etc., readily.
 Taping package can be supported.

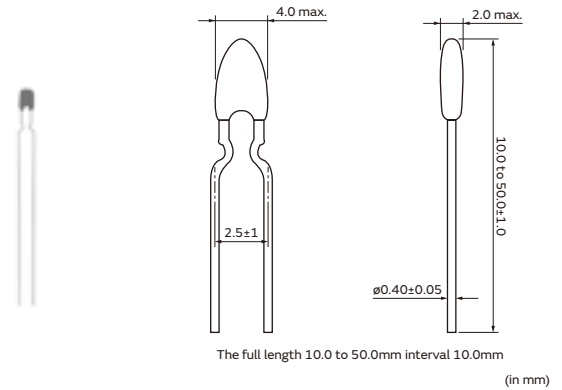

Detailed are accessible from the following URL.
<https://www.murata.com/en-global/products/thermistor/ntc/nxr>

5

Applications

1. For temperature detection of a car airconditioning
2. For temperature detection of a car electrical component
3. For temperature detection of a car light
4. For temperature detection of a medical equipment rank "C"

Part Number	Resistance (25°C) (ohm)	B-Constant (25-50°C) (K)	B-Constant (25-80°C) (Reference Value) (K)	B-Constant (25-85°C) (Reference Value) (K)	B-Constant (25-100°C) (Reference Value) (K)	Maximum Operating Current (25°C) (mA)	Rated Electric Power (25°C) (mW)	Typical Dissipation Constant (25°C) (mW/°C)	Thermal Time Constant (25°C) (s)
NXRS15XM202EA1B□□□	2k ±3%	3500 ±1%	3539	3545	3560	0.27	7.5	1.5	4
NXRS15XV302FA1B□□□	3k ±1%	3936 ±1%	3971	3977	3989	0.22	7.5	1.5	4
NXRS15XV502FA1B□□□	5k ±1%	3936 ±1%	3971	3977	3989	0.17	7.5	1.5	4
NXRS15XH103FA1B□□□	10k ±1%	3380 ±1%	3428	3434	3455	0.12	7.5	1.5	4
NXRS15XV103FA1B□□□	10k ±1%	3936 ±1%	3971	3977	3989	0.12	7.5	1.5	4
NXRS15WB333JA1B□□□	33k ±5%	4050 ±3%	4101	4108	4131	0.07	7.5	1.5	4
NXRS15WB473FA1B□□□	47k ±1%	4050 ±1%	4101	4108	4131	0.06	7.5	1.5	4
NXRS15WF104FA1B□□□	100k ±1%	4250 ±1%	4303	4311	4334	0.04	7.5	1.5	4

□□□ is filled with Total-length codes. (10 to 50mm interval 10mm, ex. 040=40mm)

Maximum Operating Current rises Thermistor's temperature by 0.1°C.

Rated Electric Power is necessary electric power that thermistor's temperature rises 5°C by self-heating at 25°C in still air.

Taping type of part numbers with "3A016" is available (Lead Spacing=5mm).

Operating Temperature Range: -40°C to +125°C

NTC Thermistors Temperature Sensor Lead Type Specifications and Test Methods

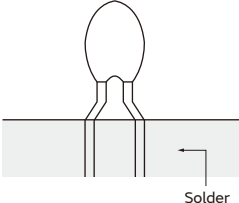
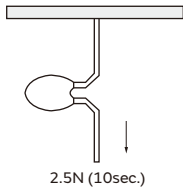
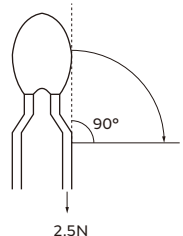
No.	Item	Specifications	Test Methods
1	Low Temperature Storage Test	<ul style="list-style-type: none"> · Resistance (R25°C) fluctuation rate: less than ±1% · B-Constant (B25/50°C) fluctuation rate: less than ±1% 	-40 +0/-3°C in air, for 1000 +48/-0hrs. without loading.
2	High Temperature Storage Test		125±2°C in air, for 1000 +48/-0hrs. without loading.
3	High Temperature Load Test	<ul style="list-style-type: none"> · Resistance (R25°C) fluctuation rate: less than ±3% · B-Constant (B25/50°C) fluctuation rate: less than ±1% 	125±2°C in air, with 'Operating Current for Sensor' for 1000 +48/-0hrs.
4	Humidity Load Test		85±2°C, 85±5%RH in air, with 'Operating Current for Sensor' for 1000 +48/-0hrs.
5	Thermal Shock		-40°C +0/-3°C, 30min. in air +125°C +3/-0°C, 30min. in air Continuous 100 cycles, without loading.
6	Insulation Break - down Voltage	· No damage electrical characteristics on D.C.100 V, 1min.	2mm length of coating resin from the top of thermistor is to be dipped into beads of lead (Pb), and DC100V 1min. is applied to circuit between beads of lead (Pb) and lead wire.
7	Resistance to Soldering Heat	<ul style="list-style-type: none"> · Resistance (R25°C) fluctuation rate: less than ±1% · B-Constant (B25/50°C) fluctuation rate: less than ±1% 	Both lead wires are dipped into 350±10°C solder for 3.5±0.5sec., or 260±5°C solder for 10±1sec. according to Fig-1. (solder <Sn-3Ag-0.5Cu>)  Fig-1
8	Solderability	· More than 90% of lead wire surface shall be covered by solder.	Both lead wires are dipped into flux (25wt% colophony <JIS K 5902> isopropyl alcohol <JIS K 8839>) for 5 to 10sec. Then both lead wires are dipped into 245±5°C solder <Sn-3Ag-0.5Cu> for 2±0.5sec. according to Fig-1.
9	Lead Wire Pull Strength	<ul style="list-style-type: none"> · Resistance(R25°C) fluctuation rate: less than ±1% · B-Constant(B25/50°C) fluctuation rate: less than ±1% · No visible damage at resin part. 	One end of a lead wire shall be fixed and 2.5N force for 10sec. shall be applied to the other lead wire as shown in Fig-2.  Fig-2
10	Lead Wire Bending Strength	· Lead wire does not break.	One lead wire is held and 2.5N force is applied. Then the body of NTC thermistor is bent by 90° and again bent back to the initial position. This sequence shall be completed twice. See Fig-3.  Fig-3
11	Free Fall	<ul style="list-style-type: none"> · Resistance (R25°C) fluctuation rate: less than ±1% · B-Constant (B25/50°C) fluctuation rate: less than ±1% · No visible damage at resin part. 	NTC thermistor shall be dropped without any force onto concrete floor from 1 meter height one time.
12	Vibration		NTC thermistor shall be fixed to the vibration test Equipment. Vibration of total 1.5mm amplitude, Frequency sequence of 10Hz – 2000Hz – 10Hz in 20min., shall be applied for right angled 3 directions for 2hrs. duration each.

* · R25 is zero-power resistance at 25°C.
 · B25/50 is calculated by zero-power resistance of Thermistor in 25°C-50°C.
 · After each test, NTC Thermistor should be kept for 1hr. at room temperature (normal humidity and normal atmospheric pressure).



NTC Thermistors for Automotive

Temperature Sensor Lead Insulation Type

This thermistor is for normal temperature level sensors having self-subsistence due to strong lead strength based on chip NTC.

Features

1. NXR series can accurately detect temperature with NCP15 series on the head of parts.
2. The insulation coat with polyurethane on the surface of lead wire : 100VDC.
3. You can choose NTC characteristics from NCP15 series.
4. The resistance drift is low in the reliability test.
5. The production capacity is bigger and NXR is produced almost entirely in an automation line.
6. Adopt to Sb regulation

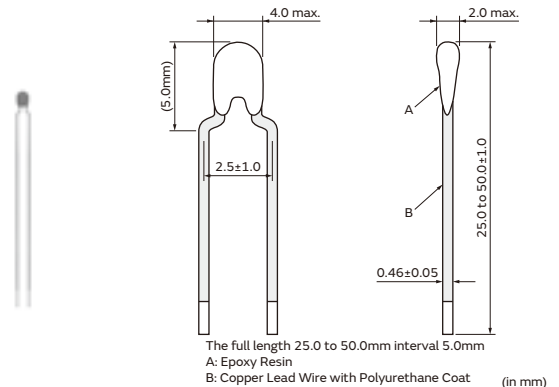

Detailed are accessible from the following URL.
<https://www.murata.com/en-global/products/thermistor/ntc/nxr>

Applications

1. For temperature detection of a car airconditioning
2. For temperature detection of a car electrical component
3. For temperature detection of a car light
4. For temperature detection of a medical equipment rank "C"

Part Number	Resistance (25°C) (ohm)	B-Constant (25-50°C) (K)	B-Constant (25-80°C) (Reference Value) (K)	B-Constant (25-85°C) (Reference Value) (K)	B-Constant (25-100°C) (Reference Value) (K)	Maximum Operating Current (25°C) (mA)	Rated Electric Power (25°C) (mW)	Typical Dissipation Constant (25°C) (mW/°C)	Thermal Time Constant (25°C) (s)
NXRS15XM202EA5B□□□	2k ±3%	3500 ±1%	3539	3545	3560	0.36	13	2.6	4
NXRS15XV302FA5B□□□	3k ±1%	3936 ±1%	3971	3977	3989	0.29	13	2.6	4
NXRS15XV502FA5B□□□	5k ±1%	3936 ±1%	3971	3977	3989	0.23	13	2.6	4
NXRS15XH103FA5B□□□	10k ±1%	3380 ±1%	3428	3434	3455	0.16	13	2.6	4
NXRS15XV103FA5B□□□	10k ±1%	3936 ±1%	3971	3977	3989	0.16	13	2.6	4
NXRS15WB333JA5B□□□	33k ±5%	4050 ±3%	4101	4108	4131	0.08	13	2.6	4
NXRS15WB473FA5B□□□	47k ±1%	4050 ±1%	4101	4108	4131	0.07	13	2.6	4
NXRS15WF104FA5B□□□	100k ±1%	4250 ±1%	4303	4311	4334	0.05	13	2.6	4

□□□ is filled with Total-length codes (25 to 50mm interval 5mm, ex. 030=30mm).

Maximum Operating Current rises Thermistor's temperature by 0.1°C.

Rated Electric Power is necessary electric power that thermistor's temperature rises 5°C by self-heating at 25°C in still air.

Operating Temperature Range: -40°C to +125°C

NTC Thermistors Temperature Sensor Lead Insulation Type Specifications and Test Methods

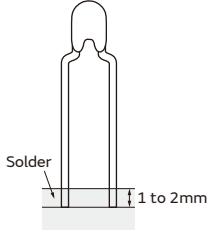
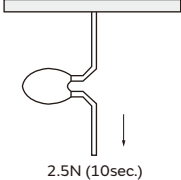
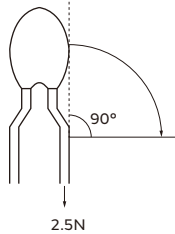
No.	Item	Specifications	Test Methods
1	Resistance to Soldering Heat (Flow)	<ul style="list-style-type: none"> Resistance (R25°C) fluctuation rate: less than ±1%. B-Constant (B25/50°C) fluctuation rate: less than ±1%. 	<p>Both lead wires are dipped into 350±10°C solder for 3.5±0.5sec., or 260±5°C solder for 10±1sec. according to Fig-1. (solder <SnAgCu>)</p>  <p style="text-align: center;">Fig-1</p>
2	Solderability (Flow)	<ul style="list-style-type: none"> More than 90% of lead wire surface shall be covered by solder. 	<p>Both lead wires are dipped into flux (25wt% colophony <JIS K 5902> isopropyl alcohol <JIS K 8839>) for 5 to 10sec. Then both lead wire are dipped into 245±5°C solder <SnAgCu> for 2±0.5sec. according to Fig-1.</p>
3	Lead Wire Breaking Strength	<ul style="list-style-type: none"> Resistance (R25°C) fluctuation rate: less than ±1%. B-Constant (B25/50°C) fluctuation rate: less than ±1%. 	<p>One end of a lead wire shall be fixed and 2.5N force for 10sec. shall be applied to the other lead wire as shown in Fig-2.</p>  <p style="text-align: center;">Fig-2</p>
4	Lead Wire Bending Strength	<ul style="list-style-type: none"> Lead wire does not break. 	<p>One lead wire is held and 2.5N force is applied. Then the body of NTC thermistor is bent by 90° and again bent back to the initial position. This sequence shall be completed twice. See Fig-3.</p>  <p style="text-align: center;">Fig-3</p>
5	Free Fall	<ul style="list-style-type: none"> Resistance (R25°C) fluctuation rate: less than ±1%. 	<p>NTC thermistor shall be dropped without any force onto concrete floor from 1 meter height one time.</p>
6	Vibration	<ul style="list-style-type: none"> B-Constant (B25/50°C) fluctuation rate: less than ±1%. No visible damage at resin part. 	<p>NTC thermistor shall be fixed to the vibration test equipment. Vibration of total 1.5 mm amplitude, frequency sequence of 10Hz - 2000Hz - 10Hz in 20min., shall be applied for right angled 3 directions for 2hrs. duration each.</p>
7	Cold	<ul style="list-style-type: none"> Resistance (R25°C) fluctuation rate: less than ±1%. 	<p>-40 +0/-3°C in air, for 1000 +48/-0hrs. without loading.</p>
8	Dry Heat	<ul style="list-style-type: none"> B-Constant (B25/50°C) fluctuation rate: less than ±1%. 	<p>125±2°C in air, for 1000 +48/-0hrs. without loading.</p>
9	High Temperature with Continuous Load		<p>125±2°C in air, with 'Operating Current for Sensor' for 1000 +48/-0hrs.</p>
10	Humidity with Continuous Load	<ul style="list-style-type: none"> Resistance (R25°C) fluctuation rate: less than ±3%. B-Constant (B25/50°C) fluctuation rate: less than ±1%. 	<p>85±2°C, 85±5%RH in air, with 'Operating Current for Sensor' for 1000 +48/-0hrs.</p>
11	Thermal Shock		<p>-40°C +0/-3°C, 30min. in air +125°C +3/-0°C, 30min. in air Continuous 100 +4/-0 cycles, without loading.</p>
12	Dielectric Breakdown Voltage	<ul style="list-style-type: none"> No damage electrical characteristics on D.C.100V, 1min. 	<p>2mm length of coating resin from the top of thermistor is to be dipped into beads of lead (Pb), and DC100V 1min. is applied to circuit between beads of lead (Pb) and lead wire.</p>

NTC Thermistors Temperature Sensor Lead/Lead Insulation Type Temperature Characteristics (Center Value)

Part Number	NXRS15XM202	NXRS15XV302	NXRS15XV502	NXRS15XH103	NXRS15XV103	NXRS15WB333	NXRS15WB473	NXRS15WF104
Resistance	2.0kΩ	3.0kΩ	5.0kΩ	10kΩ	10kΩ	33kΩ	47kΩ	100kΩ
B-Constant	3500K	3936K	3936K	3380K	3936K	4050K	4050K	4250K
Temp. (°C)	Resistance (kΩ)	Resistance (kΩ)	Resistance (kΩ)	Resistance (kΩ)	Resistance (kΩ)	Resistance (kΩ)	Resistance (kΩ)	Resistance (kΩ)
-40	44.981	101.251	168.752	195.652	337.503	1227.263	1747.920	4397.119
-35	33.671	73.000	121.666	148.171	243.332	874.449	1245.428	3088.599
-30	25.444	53.249	88.748	113.347	177.496	630.851	898.485	2197.225
-25	19.417	39.258	65.430	87.559	130.859	460.457	655.802	1581.881
-20	14.955	29.228	48.714	68.237	97.428	339.797	483.954	1151.037
-15	11.619	21.969	36.615	53.650	73.230	253.363	360.850	846.579
-10	9.097	16.659	27.764	42.506	55.529	190.766	271.697	628.988
-5	7.178	12.740	21.233	33.892	42.467	144.964	206.463	471.632
0	5.707	9.824	16.374	27.219	32.747	111.087	158.214	357.012
5	4.568	7.635	12.725	22.021	25.450	85.842	122.259	272.500
10	3.682	5.980	9.966	17.926	19.932	66.861	95.227	209.710
15	2.986	4.718	7.864	14.674	15.727	52.470	74.730	162.651
20	2.437	3.749	6.249	12.081	12.498	41.471	59.065	127.080
25	2.000	3.000	5.000	10.000	10.000	33.000	47.000	100.000
30	1.651	2.416	4.027	8.315	8.054	26.430	37.643	79.222
35	1.370	1.959	3.264	6.948	6.529	21.298	30.334	63.167
40	1.143	1.597	2.662	5.834	5.324	17.266	24.591	50.677
45	0.958	1.310	2.183	4.917	4.366	14.076	20.048	40.904
50	0.807	1.080	1.801	4.161	3.601	11.538	16.433	33.195
55	0.682	0.896	1.493	3.535	2.985	9.506	13.539	27.091
60	0.580	0.746	1.244	3.014	2.488	7.870	11.209	22.224
65	0.495	0.625	1.041	2.586	2.083	6.549	9.328	18.323
70	0.424	0.526	0.876	2.228	1.752	5.475	7.798	15.184
75	0.365	0.444	0.740	1.925	1.480	4.595	6.544	12.635
80	0.315	0.377	0.628	1.669	1.256	3.874	5.518	10.566
85	0.273	0.321	0.535	1.452	1.070	3.282	4.674	8.873
90	0.237	0.275	0.458	1.268	0.916	2.789	3.972	7.481
95	0.207	0.236	0.394	1.110	0.787	2.379	3.388	6.337
100	0.181	0.204	0.340	0.974	0.679	2.038	2.902	5.384
105	0.160	0.177	0.294	0.858	0.588	1.751	2.494	4.594
110	0.141	0.154	0.256	0.758	0.512	1.509	2.150	3.934
115	0.124	0.134	0.223	0.672	0.446	1.306	1.860	3.380
120	0.110	0.117	0.195	0.596	0.391	1.134	1.615	2.916
125	0.098	0.103	0.172	0.531	0.343	0.987	1.406	2.522

NTC Thermistors Temperature Sensor Lead/Lead Insulation Type ⚠Caution/Notice

⚠Caution (Storage and Operating Conditions)

This product is designed for application in an ordinary environment (normal room temperature, humidity and atmospheric pressure).

Do not use under the following conditions because all of these factors can deteriorate the product characteristics or cause failures and burn-out.

1. Corrosive gas or deoxidizing gas
(Chlorine gas, Hydrogen sulfide gas, Ammonia gas, Sulfuric acid gas, Nitric oxide gas, etc.)

2. Volatile or flammable gas
3. Dusty conditions
4. Under vacuum, or under high or low pressure
5. Wet or humid locations
6. Places with salt water, oils, chemical liquids or organic solvents
7. Strong vibrations
8. Other places where similar hazardous conditions exist

⚠Caution (Others)

Be sure to provide an appropriate fail-safe function on your product to prevent secondary damage that may be caused by the abnormal function or the failure of our product.

Notice (Storage and Operating Conditions)

To keep the solderability of the product from degrading, the following storage condition is recommended.

1. Storage condition:
Temperature -10 to +40°C
Humidity less than 75%RH (not dewing condition)
2. Storage term:
Use this product within 6 months after delivery by first-in and first-out stocking system.

3. Handling after unpacking:
After unpacking, reseal product promptly or store it in a sealed container with a drying agent.
4. Storage place:
Do not store this product in corrosive gas (Sulfuric acid gas, Chlorine gas, etc.) or in direct sunlight.

Notice (Rating)

Use this product within the specified temperature range.

Higher temperature may cause deterioration of the characteristics or the material quality of this product.

Notice (Soldering and Mounting)

Please note as shown below when you mount this product.

1. Do not melt the solder in the resin head, when you solder this product. If you melt the solder in resin the head, the wire could break and short.
If you cut the lead wire of this product less than 8mm from the resin head, the heat of the melted solder at the lead wire edge is propagated easily to the resin head along the lead wire. Please do not cut this product below 9mm.

2. Do not touch the resin head directly with the solder iron. It may cause the melting of solder in the resin head.
3. If you mold this product with resin, please evaluate the quality of this product before you use it.

Continued on the following page. ↗

NTC Thermistors Temperature Sensor Lead/Lead Insulation Type ⚠️Caution/Notice

Continued from the preceding page. ↘

Notice (Soldering and Mounting) Insulation Type

Please note as shown below when you mount this product.

1. Do not melt the solder in the resin head when you solder this product. (more than 25mm in full length of the product).
If you melt the solder in the resin head, it has possibility that the wire could break and short.
2. Do not touch the resin head directly with the solder iron.
It may cause the melting of solder in the resin head.
3. When additional processing is carried out on this product (such as bonding, resin molding, and resin coating, etc.), please perform an audit of quality level on an automated machine and only use the product after confirming its reliability.

Please talk to us if you have concern matter, like process it under the high temperature and the high pressure.

(For example, exposed to high-temperature and high-pressure environment as mold sealing with injection molding.)

Notice (Handling)

1. The ceramic element of this product is fragile, and care must be taken not to load an excessive press-force or not to cause a shock at handling.
Such forces may cause cracking or chipping.
2. Do not apply excessive force to the lead.
Otherwise, it may cause the junction between lead and element to break or crack. Holding the element by the side lead wire is recommended when lead wire is bent or cut.

Notice (Handling) Insulation Type

1. The ceramic element of this product is fragile, and care must be taken not to load an excessive press-force or not to cause a shock at handling.
Such forces may cause cracking or chipping.
Especially under high-temperature environment, there is a possibility that epoxy resin will become soft.
When you set up the processing environment, please examine the processing method after evaluating the quality of this product.

2. Do not apply excessive force to the lead.
Otherwise, it may cause the junction between lead and element to break or crack.
Holding the element by the side lead wire is recommended when lead wire is bent or cut.
Handle the lead with care; there is a possibility that a crack may go into the polyurethane insulated coat when bending the lead.

NTC Thermistors Chip Type/Thermo String/Lead Type Package

Minimum Quantity Guide

Part Number	Quantity (pcs.)	
	Paper Tape	Embossed Tape
NCU15	10,000	-
NCU18/NCG18	4,000	-

Part Number	Quantity (pcs.)	
	Bulk Tape	Ammo Pack Taping
NXFS	1,000	-
NXRS	500	-
NXRS_3A016	-	2,500

Chip Type/Tape Carrier Packaging

1. Dimensions of Reel

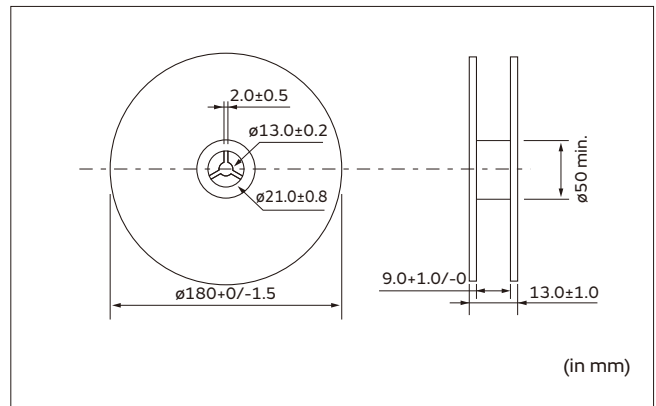

2. Taping Method

- (1) A tape in a reel contains Leader unit and Trailer unit where products are not packed. (Please refer to the figure at right.)
- (2) The top and base tapes or plastic and cover tape are not stuck at the first five pitches minimum.
- (3) A label should be attached on the reel. (MURATA's part number, inspection number and quantity should be marked on the label.)
- (4) Taping reels are packaged.

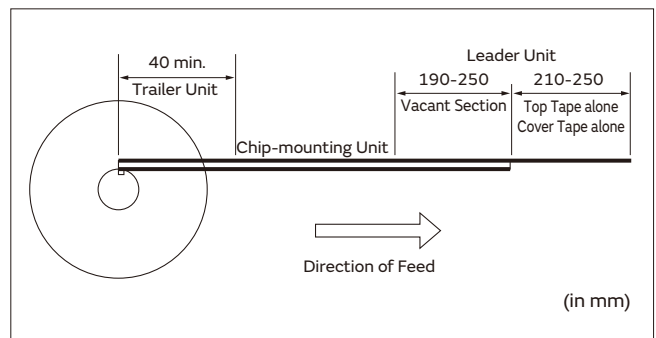

Continued on the following page. ↗

NTC Thermistors Chip Type/Thermo String/Lead Type Package

Continued from the preceding page. ↘

3. Paper Tape

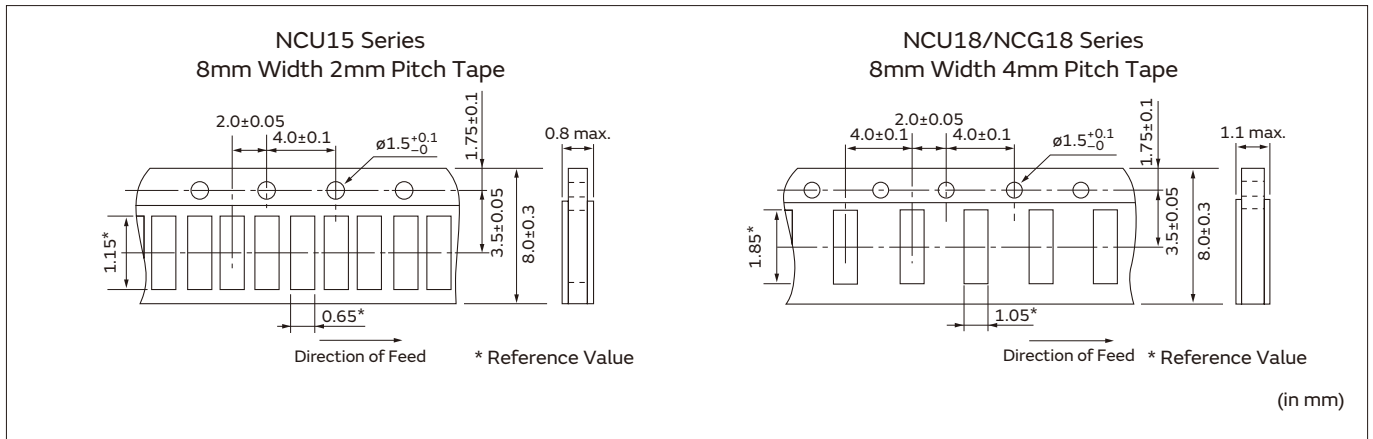

(1) Other Conditions

① Packaging

Products are packaged in the cavity of the base tape and sealed by top tape and bottom tape.

② Tape

Top tape and bottom tape have no joints and products are packaged and sealed in the cavity of the base tape, continuously.

(2) Peeling Force of Top Tape

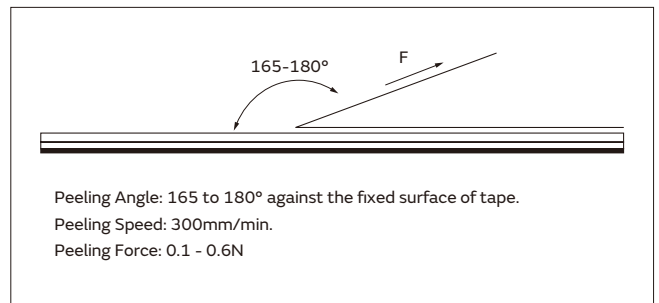

(3) Pull Strength

Pull strength of top tape is specified at 10N minimum.

Pull strength of bottom tape shall be specified 5N minimum.

NTC Thermistors Chip Type/Thermo String/Lead Type Package

Taping Dimensions (NXRS_3A016 Series)

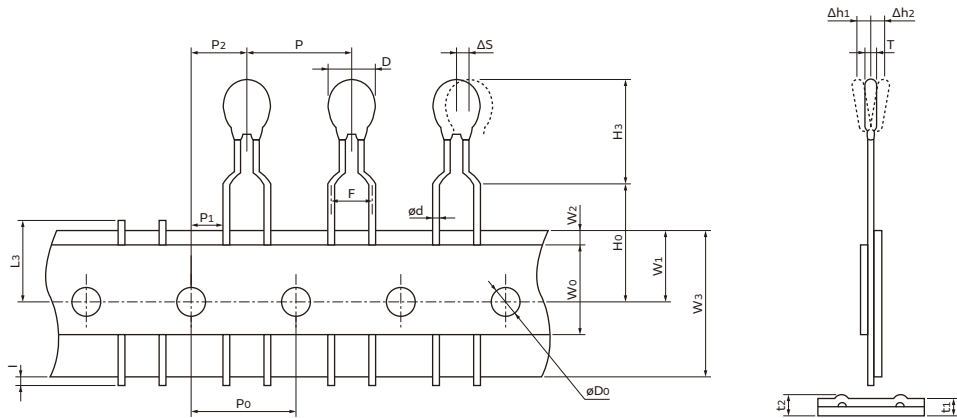

Item	Code	Dimensions (mm)
Pitch of Component	P	12.7±1.0
Pitch of Sprocket Hole	P0	12.7±0.3
Lead Spacing	F	5.0±1.0
Length from Hole Center to Component Center	P2	6.35±1.3
Length from Hole Center to Lead	P1	3.85±0.7
Body Diameter	D	4.0 max.
Deviation Along Tape, Left or Right	ΔS	0±2.0
Carrier Tape Width	W3	18.0±0.5
Position of Sprocket Hole	W1	9.0±0.5
Lead Distance between Reference and Bottom Planes	H0	16.0±1.0
Height of Component	H3	7.5±1.0
Protrusion Length	l	+0.5 to -1.0
Diameter of Sprocket Hole	øD0	4.0±0.1
Lead Diameter	ød	0.40±0.05
Total Tape Thickness	t1	0.6±0.3
Total Thickness, Tape and Lead Wire	t2	1.6 max.
Deviation Across Tape	Δh1, Δh2	1.0 max.
Portion to Cut in Case of Defect	L3	11.0 ⁺⁰ _{-2.0}
Hold down Tape Width	W0	9.5 min.
Hold down Tape Position	W2	1.5±1.5
Thickness	T	2.0 max.

PTC Thermistor (POSISTOR) for Automotive

For Overheat Sensing Chip Type 0603 (1608) Size (Meet AEC-Q200 rev.D)

This chip "POSISTOR" is an SMD type for overheat sensing in power transistors, power diodes and power ICs in hybrid circuits.

Features

1. The SMD type's small size and light weight are helpful in miniaturizing the circuit.
2. Excellent thermal response.
3. Elements of solid-state construction provide excellent mechanical vibration and impact resistance.
4. Contactless operation provides prolonged service life and noiseless operation.
5. Lead is not contained in the terminations.

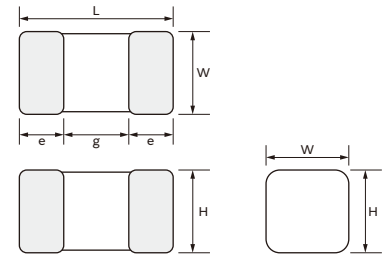

Part Number	Dimensions (mm)				
	L	W	H	e	g
PRF18_RB	1.6±0.15	0.8±0.15	0.8±0.15	0.1 to 0.6	-

Detailed are accessible from the following URL.
<https://www.murata.com/en-global/products/thermistor/ptc/prf>

Chip Type 0603 (1608) Size

Part Number	Sensing Temperature (at 4.7k ohm) (°C)	Sensing Temperature (at 47k ohm) (°C)	Maximum Voltage (V)	Resistance (at 25°C) (ohm)
PRF18AS471QS5RB	145 ±5°C	-	32	470 ±50%
PRF18AR471QS5RB	135 ±5°C	150 ±7°C	32	470 ±50%
PRF18BA471QS5RB	125 ±5°C	140 ±7°C	32	470 ±50%
PRF18BB471QS5RB	115 ±5°C	130 ±7°C	32	470 ±50%
PRF18BC471QS5RB	105 ±5°C	120 ±7°C	32	470 ±50%
PRF18BD471QS5RB	95 ±5°C	110 ±7°C	32	470 ±50%
PRF18BE471QS5RB	85 ±5°C	100 ±7°C	32	470 ±50%
PRF18BF471QS5RB	75 ±5°C	90 ±7°C	32	470 ±50%
PRF18BG471QS5RB	65 ±5°C	80 ±7°C	32	470 ±50%

This product is applied to flow/reflow soldering.
 Operating Temperature Range: -40°C to +150°C

Chip Tight Tolerance Type 0603 (1608) Size

Part Number	Sensing Temperature (at 4.7k ohm) (°C)	Sensing Temperature (at 47k ohm) (°C)	Maximum Voltage (V)	Resistance (at 25°C) (ohm)
PRF18BB471RS5RB	115 ±3°C	130 ±7°C	32	470 ±50%
PRF18BC471RS5RB	105 ±3°C	120 ±7°C	32	470 ±50%
PRF18BD471RS5RB	95 ±3°C	110 ±7°C	32	470 ±50%
PRF18BE471RS5RB	85 ±3°C	100 ±7°C	32	470 ±50%
PRF18BF471RS5RB	75 ±3°C	90 ±7°C	32	470 ±50%
PRF18BG471RS5RB	65 ±3°C	80 ±7°C	32	470 ±50%

This product is applied to flow/reflow soldering.
 Operating Temperature Range: -40°C to +150°C

Standard Land Pattern Dimensions

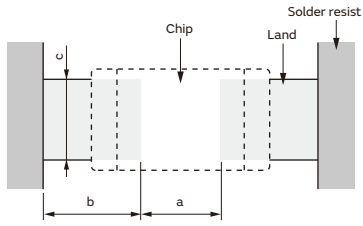

(in mm)

Part Number	Soldering Methods	Dimensions (mm)			
		Chip (L x W)	a	b	c
PRF18	Flow Soldering	1.6 x 0.8	0.6-1.0	0.8-0.9	0.6-0.8
	Reflow Soldering		0.6-0.8	0.6-0.7	0.6-0.8

Resistance-Temperature Characteristics (Typical)

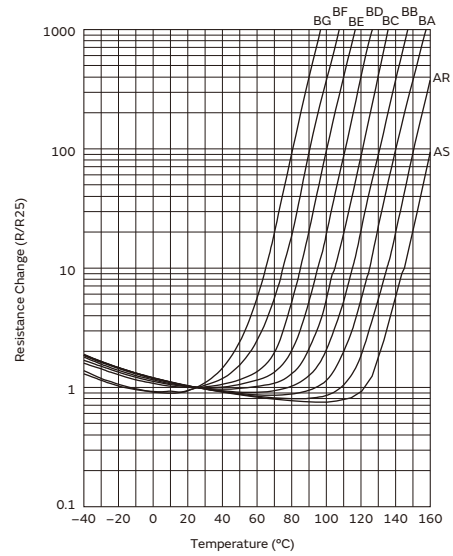

Overheat Protection Circuit

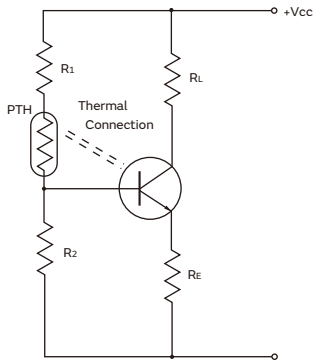

Overheat Sensing Circuit

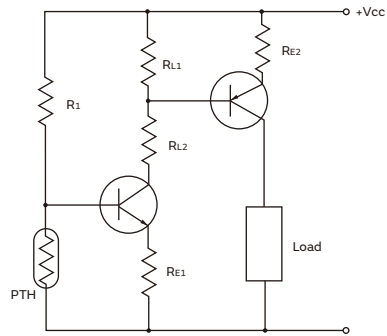

Resistance-Temperature Characteristics Range (Ref. Only)

PRF18AS471QS5RB

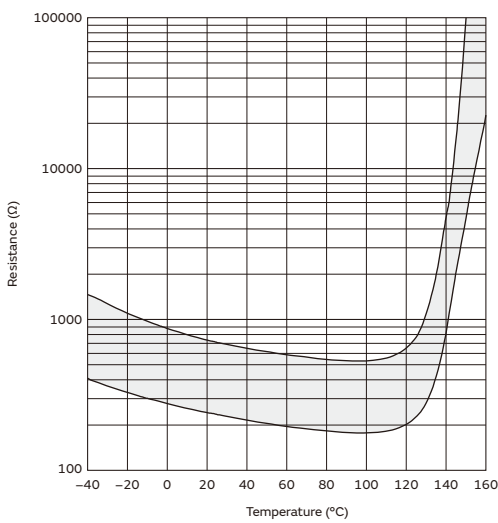

PRF18AR471QS5RB

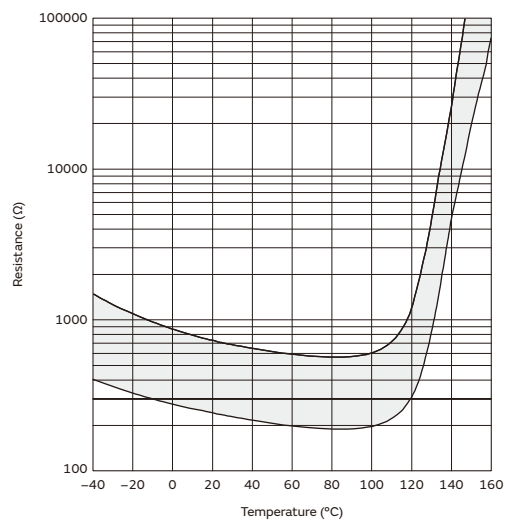

Continued on the following page. ↗

Continued from the preceding page. ↘

Resistance-Temperature Characteristics Range (Ref. Only)

PRF18BA471QS5RB

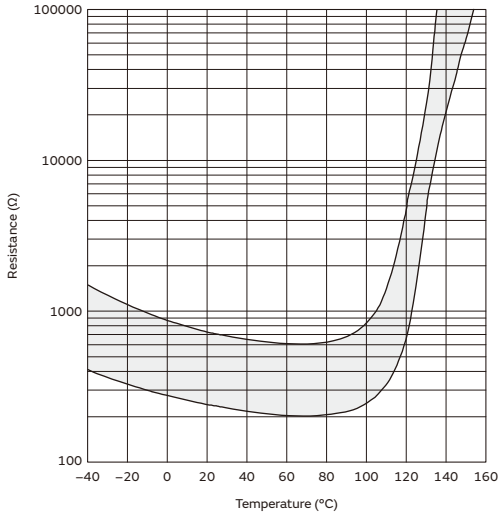

PRF18BB471QS5RB

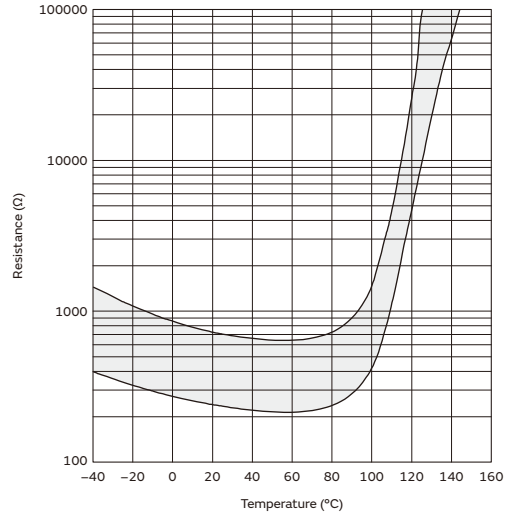

PRF18BC471QS5RB

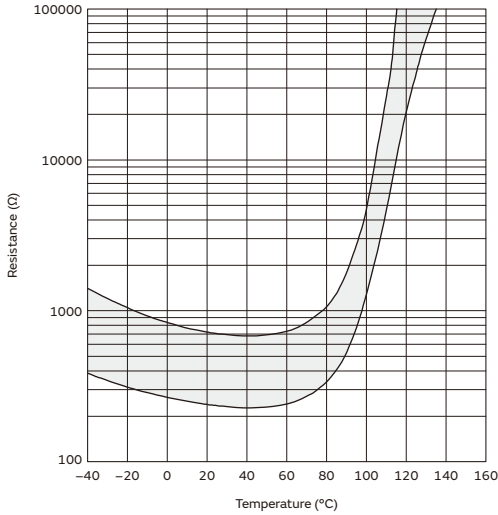

PRF18BD471QS5RB

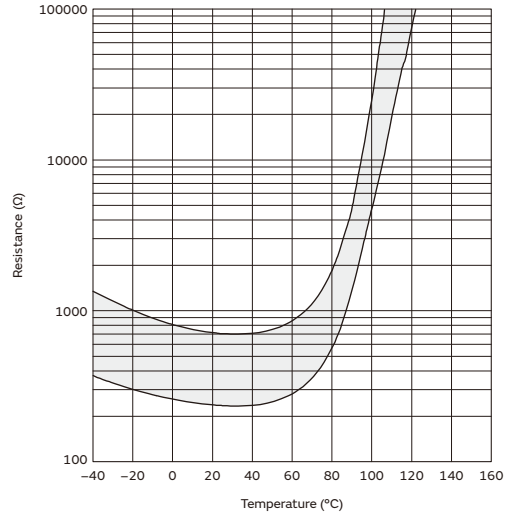

PRF18BE471QS5RB

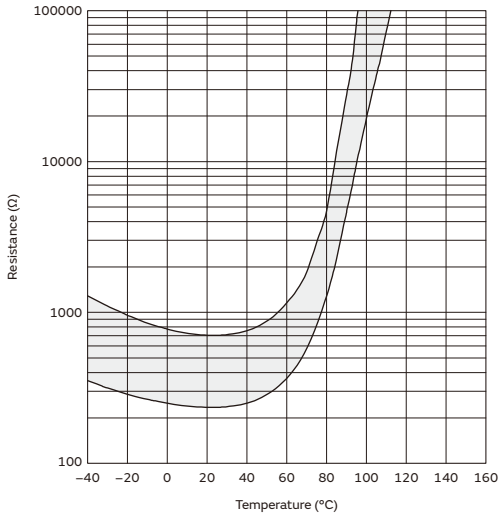

PRF18BF471QS5RB

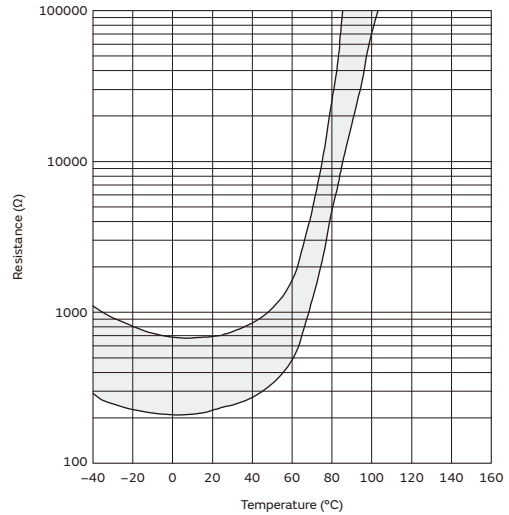

Continued on the following page. ↗

Continued from the preceding page. ↘

Resistance-Temperature Characteristics Range (Ref. Only)

PRF18BG471QS5RB

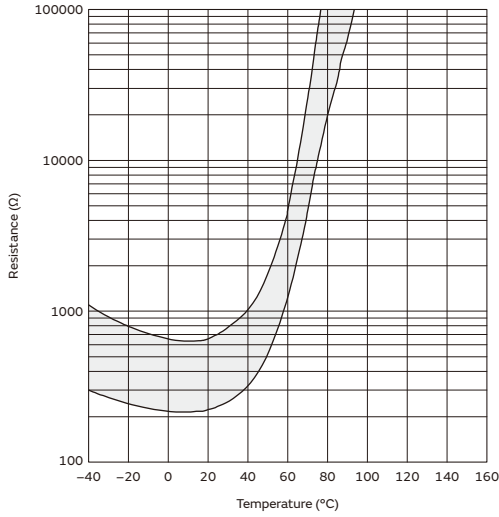

Resistance-Temperature Characteristics Range (Ref. Only) Tight Tolerance Type

PRF18BB471RS5RB

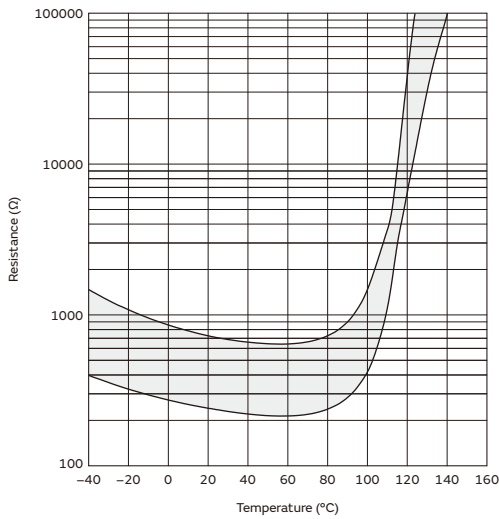

PRF18BC471RS5RB

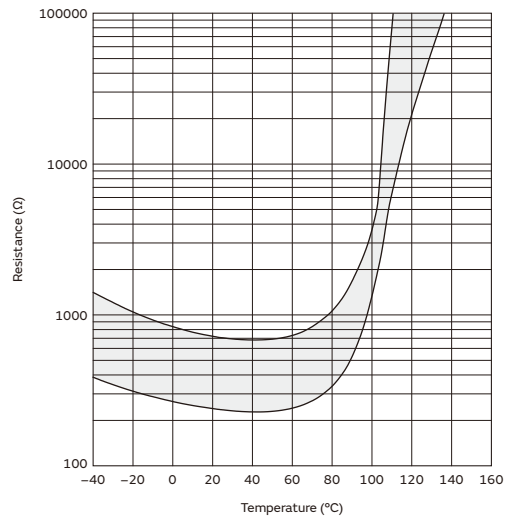

PRF18BD471RS5RB

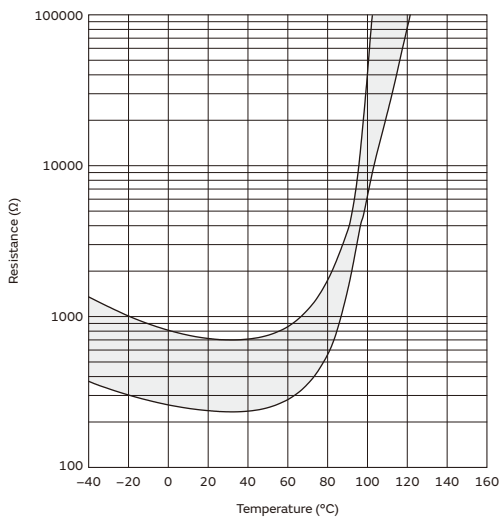

PRF18BE471RS5RB

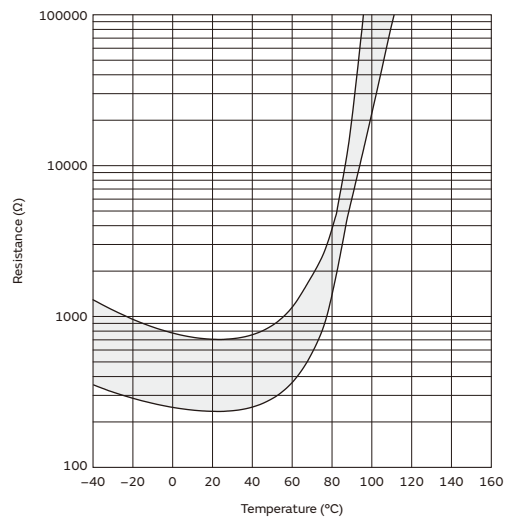

Continued on the following page. ↗

Continued from the preceding page. ↘

Resistance-Temperature Characteristics Range (Ref. Only) Tight Tolerance Type

PRF18BF471RS5RB

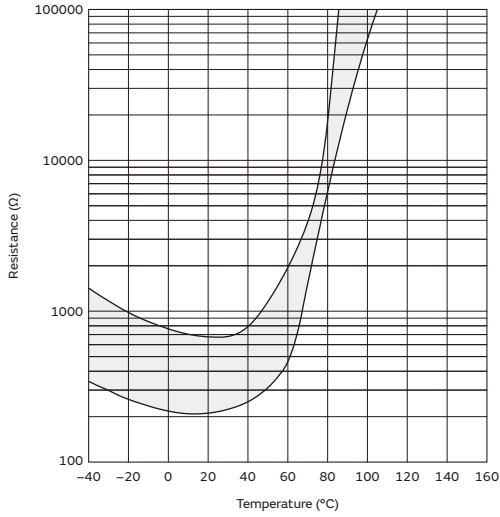

PRF18BG471RS5RB

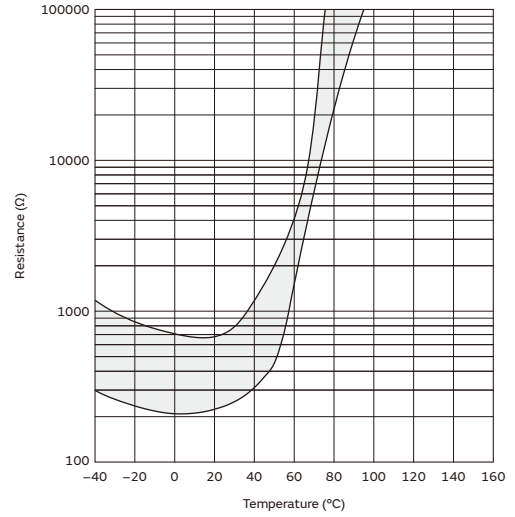

Chip Type of POSISTOR for Overheat Sensing Specifications and Test Methods

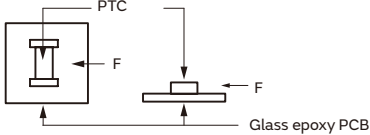
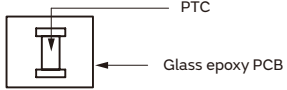
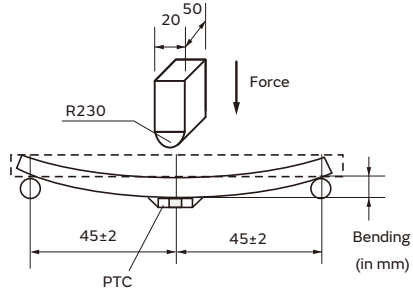
No.	Item	Rating Value	Method of Examination
1	Resistance Value (at 25°C)	The resistance value should be within the specified tolerance.	After applying maximum operating voltage for 3min. and leaving for 2hrs. at 25°C, measure by applying voltage of less than 1.5VDC (by a direct current of less than 10mA).
2	Adhesive Strength	There is no sign of electrode detachment.	EIAJ ET-7403 term 9 Prepare soldered PTC to PCB *1 and add the force of 5.0N (Hold time 10±1sec.) in the direction shown below. (PTC=POSISTOR) 
3	Vibration Resistance	There is no abnormal appearance after the test. Resistance change is less than ±20%. *2	Solder PTC to PCB *1 Vibration: 10-2000-10Hz (20 min.) Max. Amplitude: 3.0mm Sweep rate: 1 octave/min. Vibrate for 4hrs. in each of 3 mutually perpendicular planes for a total of 12 hours. This test condition is according to "MIL-STD-202G Method 204D." 
4	Resistance to Bending of Substance	There is no abnormal appearance after the test. Resistance change is less than ±20%. *2	Solder PTC on Test Board *1, and apply force on back side of Test Board shown below: Bending Speed: 1.0mm/sec. Bending Strength: 2.0mm Hold Time: 5±1sec. Board Dimension: 100x40x1.6t mm Board Material: Glass epoxy 
5	Solderability	Min. 95% electrode is covered with new solder. Resistance change is less than ±20%. *2	<ul style="list-style-type: none"> · Solder Temp.: 245±5°C · Solder: Sn63%/Pb37% (or 60%/40%) · Soaking Time: 3±0.3sec. · Soaking Position: Until a whole electrode is soaked. This test condition is according to "IEC 60068-2-58 (2004)." Reference standard: IEC 60068-2-58 (2004) Solder: Sn-3.0Ag-0.5Cu Preheat: +150 to +180°C, 120±5sec. Peak temp.: 260±5°C Soldering time: >220°C, 60 to 90sec. Reflow cycle: 1 times Test board: Glass epoxy test board (FR-4) with our standard land size
6	Soldering Heat Resistance	There is no abnormal appearance after the test. Resistance change is less than ±20%. *2	<ul style="list-style-type: none"> · Solder Temp.: 245±5°C · Solder: Sn63%/Pb37% (or 60%/40%) · Soaking Time: 3±0.3sec. · Soaking Position: Until a whole electrode is soaked. This test condition is according to "IEC 60068-2-58 (2004)." Reference standard: IEC 60068-2-58 (2004) Solder: Sn-3.0Ag-0.5Cu Preheat: +150 to +180°C, 120±5sec. Peak temp.: 260±5°C Soldering time: >220°C, 60 to 90sec. Reflow cycle: 1 times Test board: Glass epoxy test board (FR-4) with our standard land size

*1 Above-mentioned soldering is done under the following conditions at our site.

- Glass epoxy PC board
- Standard land dimension
- Standard solder paste
- Standard solder profile

Above conditions are defined in Notice.

*2 Measure resistance after the test by applying voltage of less than 1.5VDC by a direct current of less than 10mA after product is left at 25±2°C for 2 hrs.

Continued on the following page. ↗

Chip Type of POSISTOR for Overheat Sensing Specifications and Test Methods

Continued from the preceding page. ↘

No.	Item	Rating Value	Method of Examination									
7	High Temperature Storage	There is no abnormal appearance after the test. Resistance change is less than $\pm 20\%$. *2 <Tight Tolerance Type> Sensing temp. change is less than $\pm 1^\circ\text{C}$.	Solder PTC to PCB *1 $+150\pm 2^\circ\text{C}$ leave for 1000 ± 48 hrs.									
8	Low Temperature Storage		Solder PTC to PCB $-40\pm 3^\circ\text{C}$ leave for 1000 ± 48 hrs.									
9	Humidity Storage		Solder PTC to PCB *1 $+85\pm 3^\circ\text{C}$ $85\pm 5\%$ RH leave for 1000 ± 12 hrs.									
10	Thermal Shock 1 *3		<table border="1"> <thead> <tr> <th>Step</th> <th>Temp. ($^\circ\text{C}$)</th> <th>Time (min.)</th> </tr> </thead> <tbody> <tr> <td>1</td> <td>-55 ± 3</td> <td>30</td> </tr> <tr> <td>2</td> <td>$+150\pm 2$</td> <td>30</td> </tr> </tbody> </table>	Step	Temp. ($^\circ\text{C}$)	Time (min.)	1	-55 ± 3	30	2	$+150\pm 2$	30
Step	Temp. ($^\circ\text{C}$)		Time (min.)									
1	-55 ± 3		30									
2	$+150\pm 2$		30									
11	Thermal Shock 2 *3	<table border="1"> <thead> <tr> <th>Step</th> <th>Temp. ($^\circ\text{C}$)</th> <th>Time (min.)</th> </tr> </thead> <tbody> <tr> <td>1</td> <td>-55 ± 3</td> <td>30</td> </tr> <tr> <td>2</td> <td>$+125\pm 2$</td> <td>30</td> </tr> </tbody> </table>	Step	Temp. ($^\circ\text{C}$)	Time (min.)	1	-55 ± 3	30	2	$+125\pm 2$	30	
Step	Temp. ($^\circ\text{C}$)	Time (min.)										
1	-55 ± 3	30										
2	$+125\pm 2$	30										
12	High Temperature Humidity Load	Solder PTC to PCB *1 $85\pm 2^\circ\text{C}$, $85\pm 5\%$ RH (in air), load max. operating voltage for 1000 ± 48 hrs.										
13	High Temperature Continuous Load	Solder PTC to PCB *1 $85\pm 2^\circ\text{C}$ (in air), load max. operating voltage for 1000 ± 12 hrs.										

*1 Above-mentioned soldering is done under the following conditions at our site.

- Glass epoxy PC board
- Standard land dimension
- Standard solder paste
- Standard solder profile

Above conditions are defined in Notice.

*2 Measure resistance after the test by applying voltage of less than 1.5VDC by a direct current of less than 10mA after product is left at $25\pm 2^\circ\text{C}$ for 2hrs.

*3 We cannot guarantee the resistance change in Thermal Shock (No.10, 11) in a case of defective mounting.

PTC Thermistor (POSISTOR) for Automotive

For Overcurrent Protection Chip Type 0603 (1608) Size (Meet AEC-Q200 rev.D)

Overcurrent Protection device with resettable function suitable for current limiting resistor.

This product is a chip type PTC thermistor for overcurrent protection that is suitable for the following.

- Countermeasure for short circuit testing
- Current limiting resistor

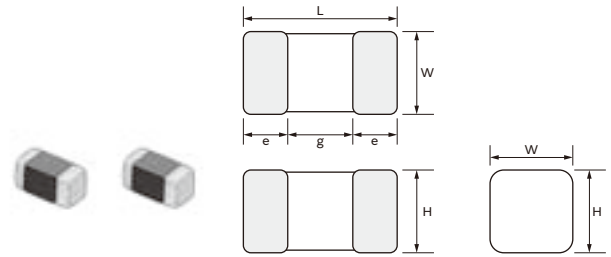

Part Number	Dimensions (mm)				
	L	W	H	e	g
PRG18_RB	1.6±0.15	0.8±0.15	0.8±0.15	0.1 to 0.6	-

Features

- Rapid operation to protect the circuit in an overcurrent condition abnormality such as a short circuit.
 By removing the overcurrent condition, these products automatically return to the initial condition and can be used repeatedly.
- Suitable for countermeasure to short circuit test in safety standard.
- Stable resistance after operation due to ceramic PTC.
- Similar size (0603 size) is possible due to the large capacity for electric power.
- Possible to use these products as current limiting resistors with overcurrent protection functions
- The SMD type's small size and light weight are helpful in miniaturizing the circuit.

Detailed are accessible from the following URL.
<https://www.murata.com/en-global/products/thermistor/ptc/prg>

Part Number	Max. Voltage (V)	Hold Current (mA)		Trip Current (mA)			Max. Current (mA)	Resistance (at +25°C) (ohm)
		at +75°C	at +25°C	at +25°C	at -20°C	at -40°C		
PRG18BB330MS1RB	16	18	36	71	90	97	600	33 ±20%
PRG18BB470MS1RB	16	14	29	61	78	84	420	47 ±20%
PRG18BB101MS1RB	16	12	21	45	56	61	200	100 ±20%
PRG18BB221MS1RB	16	8	14	29	36	39	90	220 ±20%
PRG18BB471MS1RB	16	5	10	21	26	28	40	470 ±20%

Maximum Current shows typical capacities at which the transformer can be used.
 Operating Temperature Range -40°C to +75°C

Standard Land Pattern Dimensions

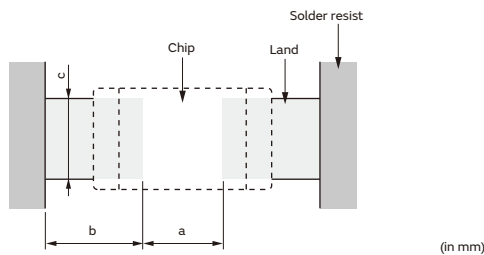

Part Number	Soldering Methods	Dimensions (mm)			
		Chip (L x W)	a	b	c
PRG18	Reflow Soldering	1.8 x 0.8	0.6-0.8	0.6-0.7	0.6-0.8

Protective Threshold Current Range

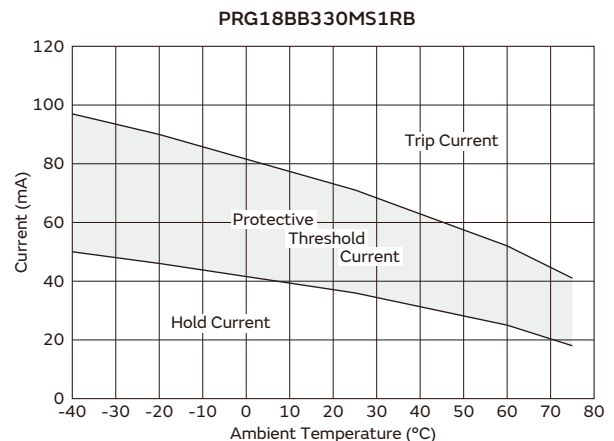

Continued on the following page. ↗

Continued from the preceding page. ↘

Protective Threshold Current Range

PRG18BB470MS1RB

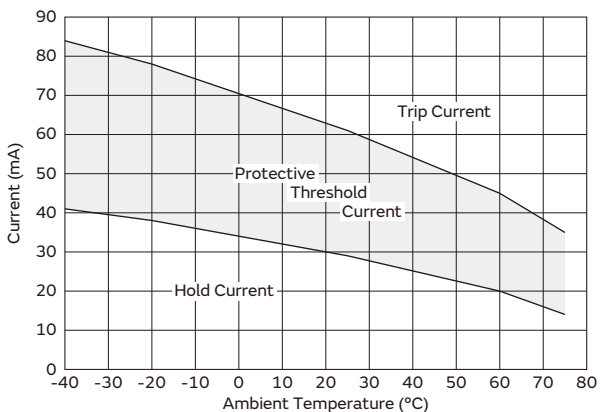

PRG18BB101MS1RB

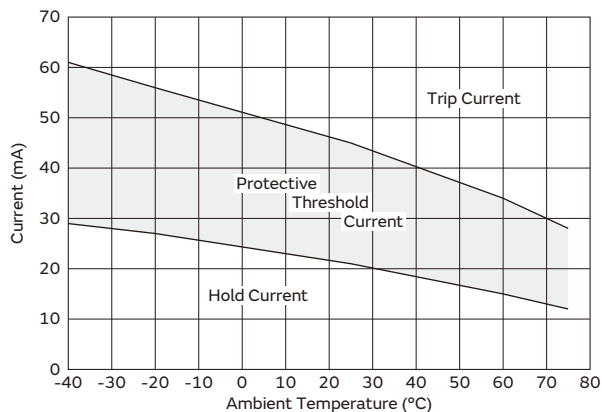

PRG18BB221MS1RB

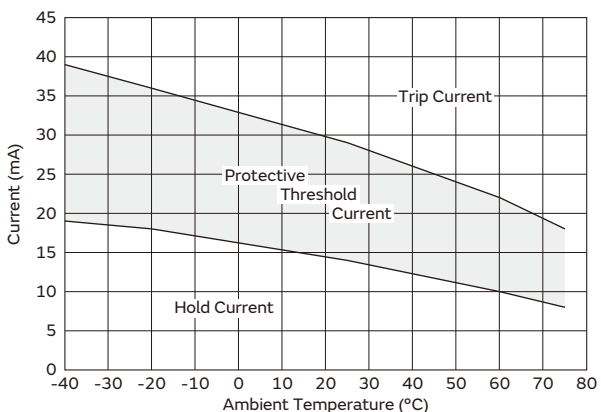

PRG18BB471MS1RB

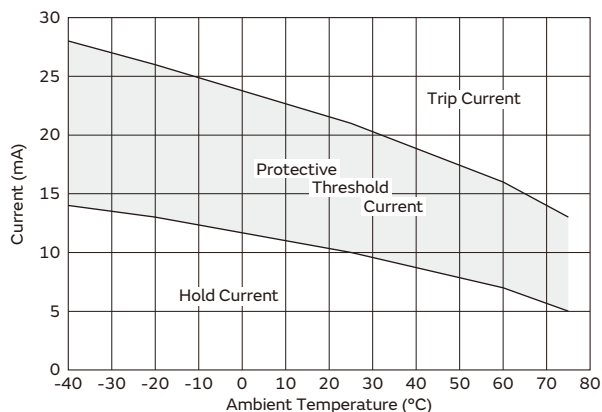

Operating Time (Typical Curve)

PRG18BB330MS1RB

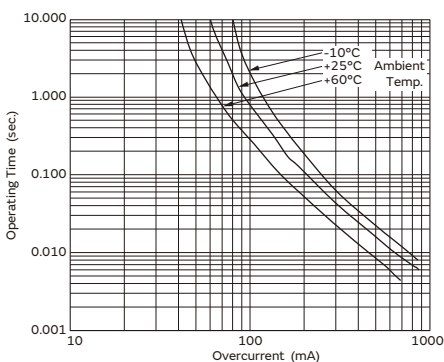

PRG18BB470MS1RB

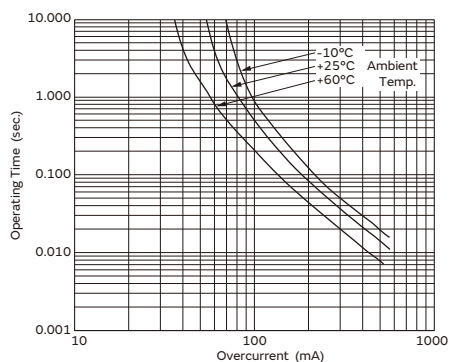

PRG18BB101MS1RB

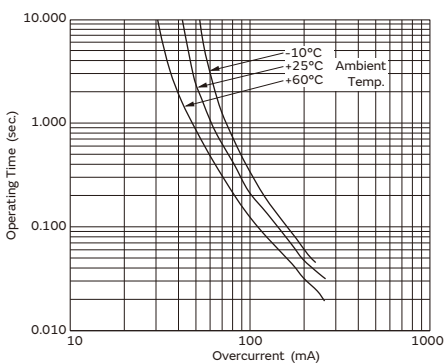

PRG18BB221MS1RB

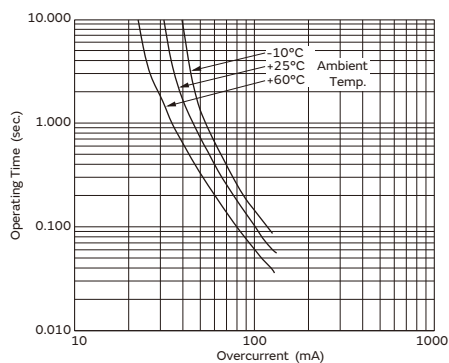

Continued from the preceding page. ↘

Operating Time (Typical Curve)

PRG18BB471MS1RB

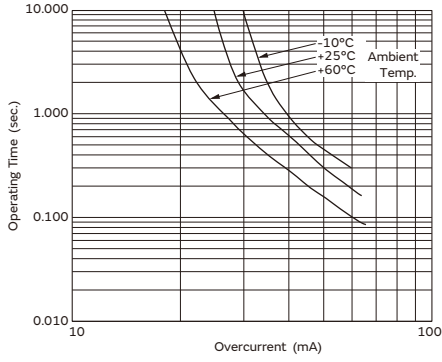

Chip Type of POSISTOR for Overcurrent Protection Specifications and Test Methods

PRG18BB□□□MS1RB

No.	Item	Rating Value	Mention of Examination
1	Operating Temp. Range	-20 to +75°C	Temperature range that permit to apply max. voltage to the POSISTOR.
2	Storage Temp. Range	-40 to +125°C	Temperature range that permit to leaving without applying power to the POSISTOR.
3	Resistance Value at 25°C	Within the specified range.	It is measured by below flow. 1) Applied max. voltage for 3min. 2) Storage 2hrs. in room temperature 3) Measured by four-terminal method with less than 10mA (DC 1.5V)
4	Shear Test	• Resistance (R25) change: Less than ±20% *1 • Appearance: No defects or abnormalities	Reference standard: IEC 60068-2-21 (1999) • Solder PTC to PCB *2 • Test board: Glass epoxy test board (FR-4) with our standard land size • Pushing force: 5N • Keep time: 10+/-1sec.
5	Vibration		Reference standard: MIL-STD-202G Method 204D • Solder PTC to PCB *2 • Frequency range: 10Hz to 2kHz to 10Hz (About 20min.) • Amplitude: 3.0mm • Sweep rate: 1 octave/min. • Direction: X-Y-Z (3 direction) • Test time: 12hrs. (4hrs. for each axis)
6	Bending Test		Reference standard: IEC 60068-2-21 (1999) • Solder PTC to PCB *2 Board dimension: 100×40×1.6mm (Glass epoxy board) • Bending speed: 1.0mm/sec. • Bending depth: 2.0mm • Keep time: 5±1sec.
7	Solderability	Wetting of soldering area: ≥95%	Reference standard: IEC 60068-2-58 (2004) • Solder: Sn-3.0Ag-0.5Cu • Solder temp.: 245±5°C • Immersion time: 3±0.3sec.

*1: The resistance value after the test is measured by 4-terminal method with less than 10mA (DC1.5V), after storage in 25±2°C for 2hrs.

*2: Above-mentioned soldering is done following condition at our side.

- Glass epoxy PC board
- Standard land dimension
- Standard solder paste
- Standard solder profile

Above conditions are defined in Notice.

Continued on the following page. ↗

Chip Type of POSISTOR for Overcurrent Protection Specifications and Test Methods

Continued from the preceding page. ↘

No.	Item	Rating Value	Mention of Examination									
8	Resistance to Soldering Heat		Reference standard: IEC 60068-2-58 (2004) [Reflow Method] · Solder: Sn-3.0Ag-0.5Cu · Preheat: +150 to +180°C, 120±5sec. · Peak temp.: 260±5°C · Soldering time: >220°C, 60 to 90sec. · Reflow cycle: 1 times · Test board: Glass epoxy test board (FR-4) with our standard land size									
9	High Temperature Storage		Reference standard: IEC 60068-2-2 (2007) · Solder PTC to PCB *2 · +125±2°C · 1000+48/-0hrs.									
10	Low Temperature Storage		Reference standard: IEC 60068-2-1 (2007) · Solder PTC to PCB *2 · -40±3°C · 1000+48/-0hrs.									
11	Damp Heat, Steady State	· Resistance (R25) change: Less than ±20% *1 · Appearance: No defects or abnormalities	Reference standard: IEC 60068-2-67 (1995) · Solder PTC to PCB *2 · +85±2°C, 85±5%RH · 1000+48/-0hrs.									
12	Thermal Shock *3		Reference standard: IEC 60068-2-14 (2009) [Test Na] · Solder PTC to PCB *2 · Transport time: <3min. · Test condition: See below table <table border="1" style="margin-left: 20px;"> <thead> <tr> <th>Step</th> <th>Condition</th> <th>Soaking Time</th> </tr> </thead> <tbody> <tr> <td>1</td> <td>-55±3°C</td> <td>30min.</td> </tr> <tr> <td>2</td> <td>+125±2°C</td> <td>30min.</td> </tr> </tbody> </table> · Test cycle: 1000 cycles	Step	Condition	Soaking Time	1	-55±3°C	30min.	2	+125±2°C	30min.
Step	Condition	Soaking Time										
1	-55±3°C	30min.										
2	+125±2°C	30min.										
13	High Temperature Load		Reference standard: IEC 60068-2-2 (2007) · Solder PTC to PCB *2 · +85±2°C · Applied max. voltage: 1.5hrs., OFF: 0.5hrs. · 1000+48/-0hrs.									
14	Damp Heat Load		Reference standard: IEC 60068-2-67 (1995) · Solder PTC to PCB *2 · +85±2°C, 85±5%RH · Applied max. voltage · 1000+48/-0hrs.									

*1: The resistance value after the test is measured by 4-terminal method with less than 10mA (DC1.5V), after storage in 25±2°C for 2hrs.

*2: Above-mentioned soldering is done following condition at our side.

- Glass epoxy PC board
- Standard land dimension
- Standard solder paste
- Standard solder profile

Above conditions are defined in Notice.

*3: We cannot guarantee the resistance change in Thermal Shock in a case of defective mounting.

PTC Thermistor (POSISTOR) for Automotive

For Overcurrent Protection Chip Type 0805 (2012) Size (Meet AEC-Q200 rev.D)

Overcurrent Protection device with resettable function suitable for current limiting resistor.

This product is a chip type PTC thermistor for overcurrent protection that is suitable for the following.

Countermeasure for short circuit testing

Current limiting resistor

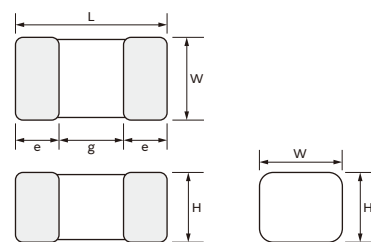

Part Number	Dimensions (mm)				
	L	W	H	e	g
PRG21_RA	2.0±0.2	1.25±0.2	0.9±0.2	0.2 min.	0.5 min.
PRG21_RK	2.0±0.2	1.25±0.2	1.25±0.2	0.2 min.	0.5 min.

Features

1. Rapid operation to protect the circuit in an overcurrent condition abnormality such as a short circuit.
 By removing the overcurrent condition, these products automatically return to the initial condition and can be used repeatedly.
2. Suitable for countermeasure to short circuit test in safety standard.
3. Stable resistance after operation due to ceramic PTC.
4. Similar size (0603 size) is possible due to the large capacity for electric power.
5. Possible to use these products as current limiting resistors with overcurrent protection functions
6. The SMD type's small size and light weight are helpful in miniaturizing the circuit.

Detailed are accessible from the following URL.
<https://www.murata.com/en-global/products/thermistor/ptc/prg>

Part Number	Max. Voltage (V)	Hold Current (mA)			Trip Current (mA)		Max. Current (mA)	Resistance (at +25°C) (ohm)
		at +105°C	at +85°C	at +25°C	at +25°C	at -40°C		
PRG21AR220MS5RA	30	28	45	80	150	205	1710	22 ±20%
PRG21AR150MS5RA	30	33	55	95	180	250	2500	15 ±20%
PRG21AR100MS5RA	30	40	65	115	225	315	3750	10 ±20%
PRG21AR8R2MS5RA	16	45	70	130	245	345	2440	8.2 ±20%
PRG21AR4R7MS5RA	16	75	110	205	390	525	4260	4.7 ±20%
PRG21BC6R8MS5RA	30	-	40	112	260	365	5500	6.8 ±20%
PRG21BC4R7MS5RA	30	-	48	145	330	460	8000	4.7 ±20%
PRG21BC3R3MS5RA	20	-	60	168	400	540	7500	3.3 ±20%
PRG21BC2R2MS5RA	16	-	76	206	500	670	9000	2.2 ±20%
PRG21AR420MS1RA	20	15	25	54	100	130	590	42 ±20%
PRG21AR220MS1RK	16	25	45	75	195	250	900	22 ±20%

Maximum Current shows typical capacities at which the transformer can be used.

Operating Temperature Range PRG21AR□□□MS5RA, PRG21AR□□□MS1R□ -40°C to +105°C

PRG21BC□□□MS5RA -40°C to +85°C

Standard Land Pattern Dimensions

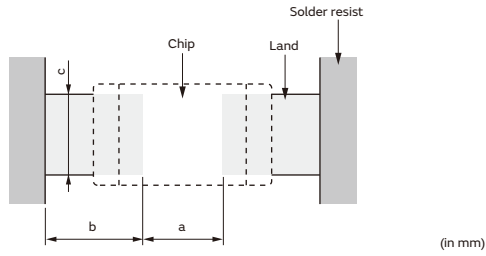

Part Number	Soldering Methods	Dimensions (mm)			
		Chip (L x W)	a	b	c
PRG21	Reflow Soldering	2.0 x 1.25	1.0-1.2	0.5-0.7	1.0-1.2

Protective Threshold Current Range

PRG21AR220MS5RA

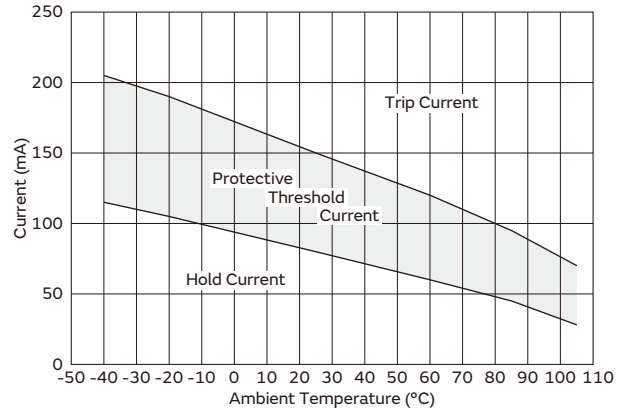

PRG21AR150MS5RA

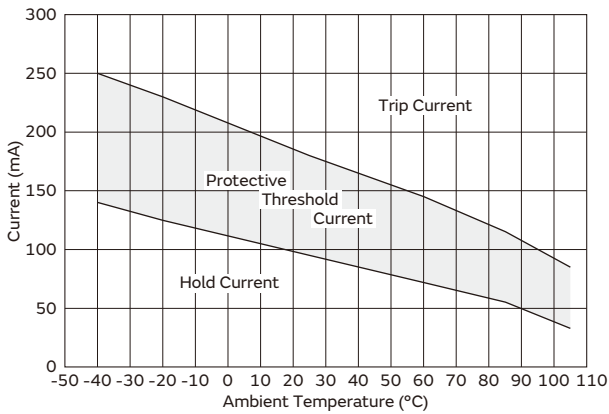

PRG21AR100MS5RA

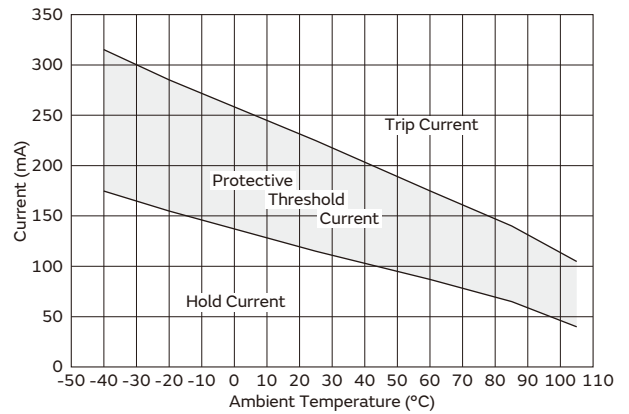

PRG21AR8R2MS5RA

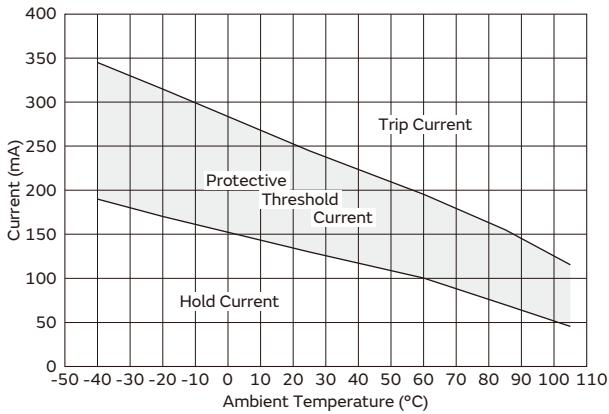

PRG21AR4R7MS5RA

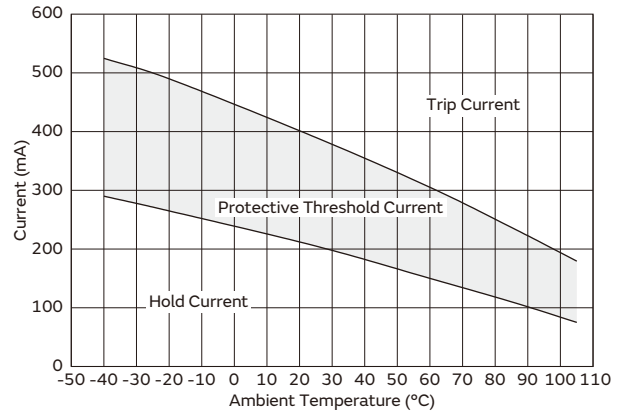

PRG21BC6R8MS5RA

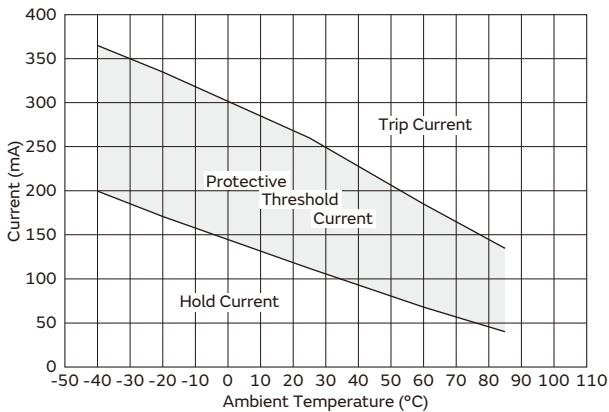

PRG21BC4R7MS5RA

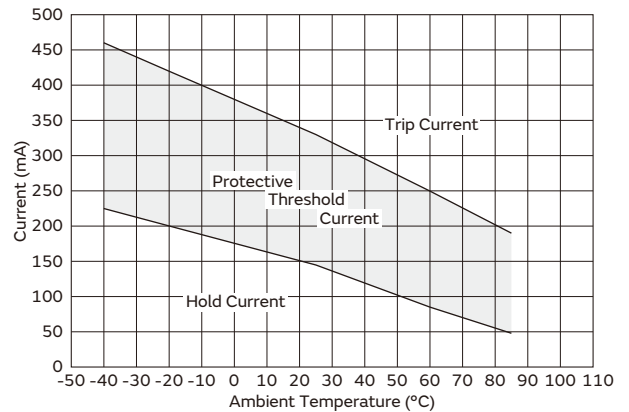

Continued on the following page. ↗

Continued from the preceding page. ↘

Protective Threshold Current Range

PRG21BC3R3MS5RA

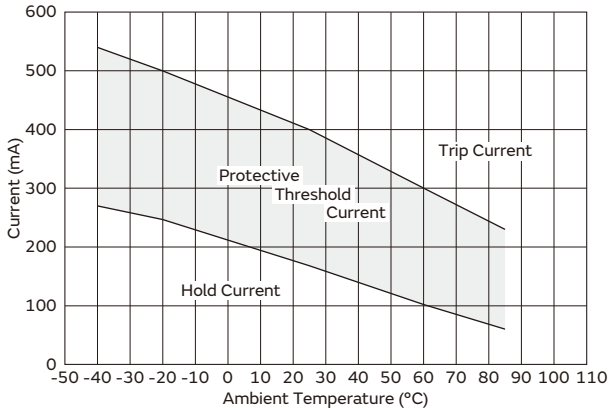

PRG21BC2R2MS5RA

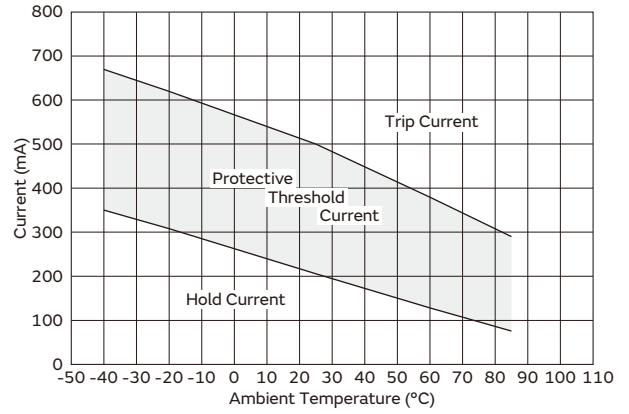

PRG21AR420MS1RA

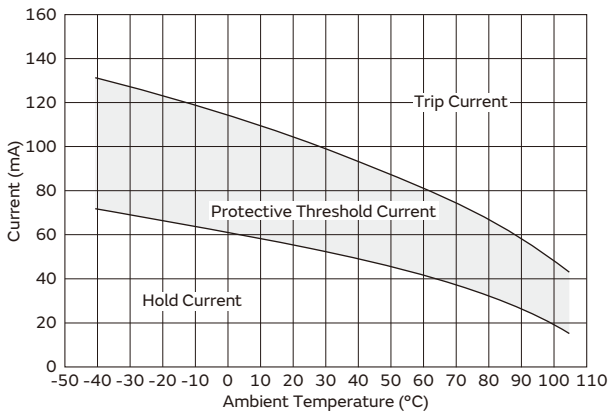

PRG21AR220MS1RK

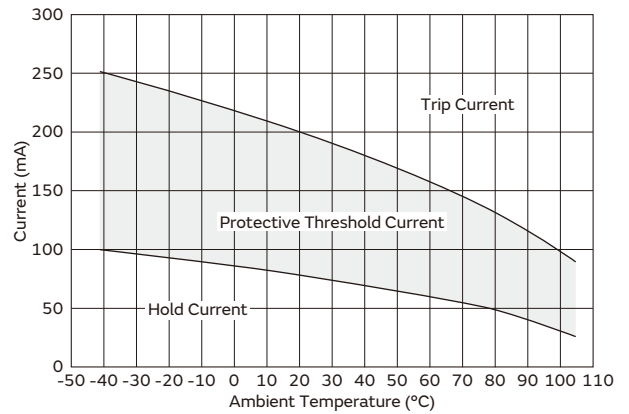

Operating Time (Typical Curve)

PRG21AR220MS5RA

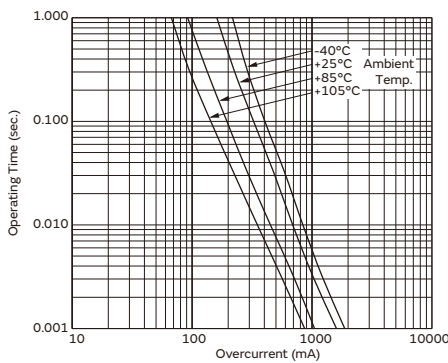

PRG21AR150MS5RA

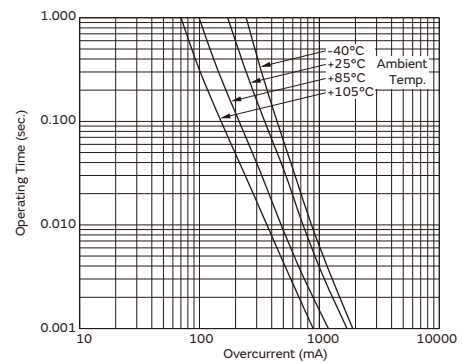

PRG21AR100MS5RA

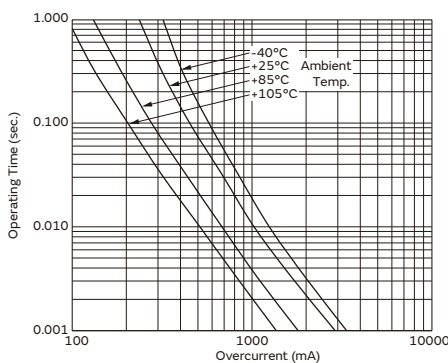

PRG21AR8R2MS5RA

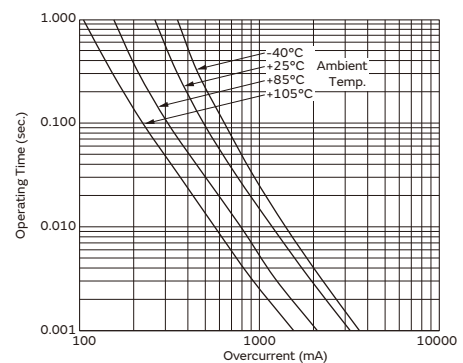

Continued on the following page. ↗

Continued from the preceding page. ↘

Operating Time (Typical Curve)

PRG21AR4R7MS5RA

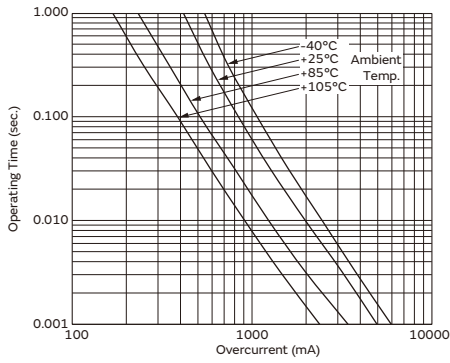

PRG21BC6R8MS5RA

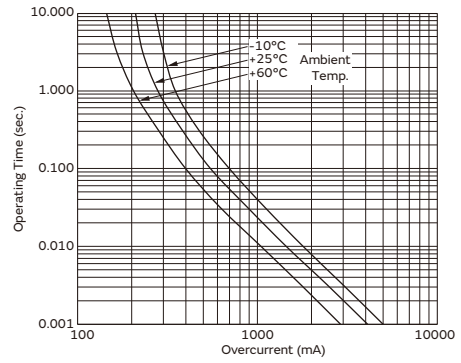

PRG21BC4R7MS5RA

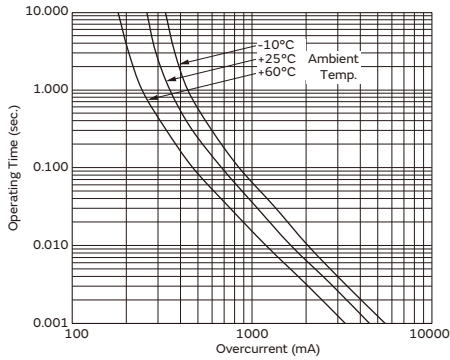

PRG21BC3R3MS5RA

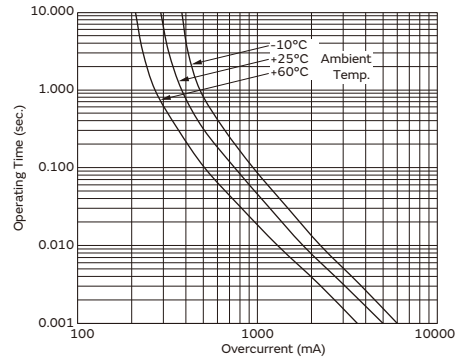

PRG21BC2R2MS5RA

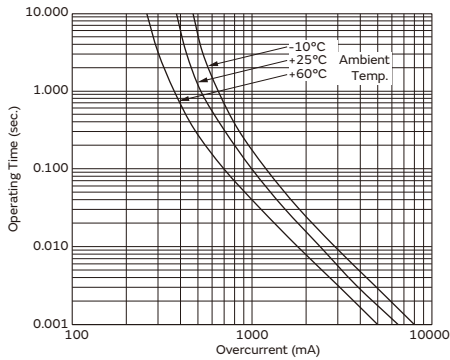

PRG21AR420MS1RA

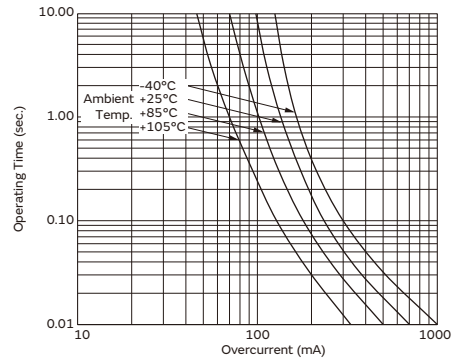

PRG21AR220MS1RK

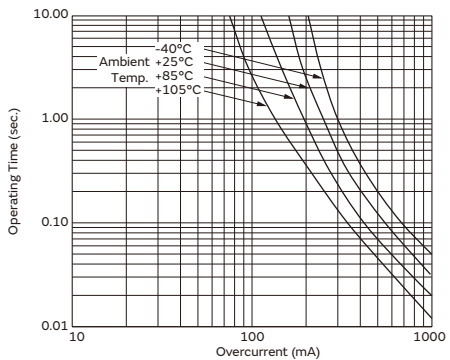

Chip Type of POSISTOR for Overcurrent Protection Specifications and Test Methods

PRG21AR□□□MS5RA, PRG21BC□□□MS5RA

No.	Item	Rating Value	Mention of Examination
1	Operating Temp. Range	PRG21AR□□□MS5RA -40 to +105°C PRG21BC□□□MS5RA -40 to +85°C	Temperature range that permit to apply max. voltage to the POSISTOR.
2	Storage Temp. Range	-40 to +125°C	Temperature range that permit to leaving without applying power to the POSISTOR.
3	Resistance Value at 25°C	Within the specified range.	It is measured by below flow. 1) Applied max. voltage for 3min. 2) Storage 2hrs. in room temperature 3) Measured by four-terminal method with less than 10mA
4	Shear Test	· Resistance (R25) change: Less than ±20% *1 · Appearance: No defects or abnormalities	Reference standard: IEC 60068-2-21 (1999) · Solder PTC to PCB *2 · Test board: Glass epoxy test board (FR-4) with our standard land size · Pushing force: 10N · Keep time: 10±1sec.
5	Vibration		Reference standard: MIL-STD-202G Method 204D · Solder PTC to PCB *2 · Frequency range: 10-2000-10Hz (20 min.) · Amplitude: 3mm · Sweep rate: 1 octave/min. · Direction: X-Y-Z (3 direction) · Test time: 12hrs. (4hrs. for each axis)
6	Bending Test		Reference standard: IEC 60068-2-21 (1999) · Solder PTC to PCB *2 Board dimension: 100×40×1.6mm (Glass epoxy board) · Bending speed: 1.0mm/sec. · Bending depth: 1.0mm · Keep time: 5±1sec.
7	Solderability	Wetting of soldering area: ≥75%	Reference standard: IEC 60068-2-58 (2004) · Solder: Sn-3.0Ag-0.5Cu · Solder temp.: 245±5°C · Immersion time: 3±0.3sec.

*1: The resistance value after the test is measured by 4-terminal method with less than 10mA, after storage in 25±2°C for 2hrs.

*2: Above-mentioned soldering is done following condition at our side.

- Glass epoxy PC board
- Standard land dimension
- Standard solder paste
- Standard solder profile

Above conditions are defined in Notice.

Continued on the following page. ↗

Chip Type of POSISTOR for Overcurrent Protection Specifications and Test Methods

Continued from the preceding page. ↘

No.	Item	Rating Value	Mention of Examination									
8	Resistance to Soldering Heat		Reference standard: IEC 60068-2-58 (2004) [Reflow Method] · Solder: Sn-3.0Ag-0.5Cu · Preheat: +150 to +180°C, 120±5sec. · Peak temp.: 260±5°C · Soldering time: >220°C, 60 to 90sec. · Reflow cycle: 2 times · Test board: Glass epoxy test board (FR-4) with our standard land size									
9	High Temperature Storage		Reference standard: IEC 60068-2-2 (2007) · Solder PTC to PCB *2 · +125±2°C · 1000+48/-0hrs.									
10	Low Temperature Storage		Reference standard: IEC 60068-2-1 (2007) · Solder PTC to PCB *2 · -40±3°C · 1000+48/-0hrs.									
11	Damp Heat, Steady State	· Resistance (R25) change: Less than ±20% *1 · Appearance: No defects or abnormalities	Reference standard: IEC 60068-2-67 (1995) · Solder PTC to PCB *2 · +85±2°C, 85±5%RH · 1000+48/-0hrs.									
12	Thermal Shock *3		Reference standard: IEC 60068-2-14 (2009) [Test Na] · Solder PTC to PCB *2 · Transport time: <10sec. · Test condition: See below table <table border="1" style="margin-left: 20px;"> <thead> <tr> <th>Step</th> <th>Condition</th> <th>Soaking Time</th> </tr> </thead> <tbody> <tr> <td>1</td> <td>-40±3°C</td> <td>30min.</td> </tr> <tr> <td>2</td> <td>+125±2°C</td> <td>30min.</td> </tr> </tbody> </table> · Test cycle: 1000cycles	Step	Condition	Soaking Time	1	-40±3°C	30min.	2	+125±2°C	30min.
Step	Condition	Soaking Time										
1	-40±3°C	30min.										
2	+125±2°C	30min.										
13	High Temperature Load		Reference standard: IEC 60068-2-2 (2007) · Solder PTC to PCB *2 · PRG21AR□□□MS5RA +105±2°C · PRG21BC□□□MS5RA +85±2°C · Applied max. voltage · 1000+48/-0hrs.									
14	Damp Heat Load		Reference standard: IEC 60068-2-67 (1995) · Solder PTC to PCB *2 · +85±2°C, 85±5%RH · Applied max. voltage · 1000+48/-0hrs.									

*1: The resistance value after the test is measured by 4-terminal method with less than 10mA, after storage in 25±2°C for 2hrs.

*2: Above-mentioned soldering is done following condition at our side.

- Glass epoxy PC board
- Standard land dimension
- Standard solder paste
- Standard solder profile

Above conditions are defined in Notice.

*3: We cannot guarantee the resistance change in Thermal Shock in a case of defective mounting.

Chip Type of POSISTOR for Overcurrent Protection Specifications and Test Methods

PRG21AR□□□MS1R□

No.	Item	Rating Value	Mention of Examination
1	Operating Temp. Range	-40 to +105°C	Temperature range that permit to apply max. voltage to the POSISTOR.
2	Storage Temp. Range	-40 to +125°C	Temperature range that permit to leaving without applying power to the POSISTOR.
3	Resistance Value at 25°C	Within the specified range.	It is measured by below flow. 1) Applied max. voltage for 3min. 2) Storage 2hrs. in room temperature 3) Measured by four-terminal method with less than 10mA
4	Shear Test	· Resistance (R25) change: Less than ±20% *1 · Appearance: No defects or abnormalities	Reference standard: IEC 60068-2-21 (1999) · Solder PTC to PCB *2 · Test board: Glass epoxy test board (FR-4) with our standard land size · Pushing force: 5N · Keep time: 10+/-1sec.
5	Vibration		Reference standard: MIL-STD-202G Method 204D · Solder PTC to PCB *2 · Frequency range: 10Hz to 2kHz to 10Hz (About 20 min.) · Amplitude: 3.0mm · Sweep rate: 1 octave/min. · Direction: X-Y-Z (3 direction) · Test time: 12hrs. (4hrs. for each axis)
6	Bending Test		Reference standard: IEC 60068-2-21 (1999) · Solder PTC to PCB *2 Board dimension: 100×40×1.6mm (Glass epoxy board) · Bending speed: 1.0mm/sec. · Bending depth: 2.0mm · Keep time: 5±1sec.
7	Solderability	Wetting of soldering area: ≥95%	Reference standard: IEC 60068-2-58 (2004) · Solder: Sn-3.0Ag-0.5Cu · Solder temp.: 245±5°C · Immersion time: 3±0.3sec.

*1: The resistance value after the test is measured by 4-terminal method with less than 10mA, after storage in 25±2°C for 2hrs.

*2: Above-mentioned soldering is done following condition at our side.

- Glass epoxy PC board
- Standard land dimension
- Standard solder paste
- Standard solder profile

Above conditions are defined in Notice.

Continued on the following page. ↗

Chip Type of POSISTOR for Overcurrent Protection Specifications and Test Methods

Continued from the preceding page. ↘

No.	Item	Rating Value	Mention of Examination									
8	Resistance to Soldering Heat		Reference standard: IEC 60068-2-58 (2004) [Reflow Method] · Solder: Sn-3.0Ag-0.5Cu · Preheat: +150 to +180°C, 120±5sec. · Peak temp.: 260±5°C · Soldering time: >220°C, 60 to 90sec. · Reflow cycle: 1 time · Test board: Glass epoxy test board (FR-4) with our standard land size									
9	High Temperature Storage		Reference standard: IEC 60068-2-2 (2007) · Solder PTC to PCB *2 · +125±2°C · 1000+48/-0hrs.									
10	Low Temperature Storage		Reference standard: IEC 60068-2-1 (2007) · Solder PTC to PCB *2 · -40±3°C · 1000+48/-0hrs.									
11	Damp Heat, Steady State	· Resistance (R25) change: Less than ±20% *1 · Appearance: No defects or abnormalities	Reference standard: IEC 60068-2-67 (1995) · Solder PTC to PCB *2 · +85±2°C, 85±5%RH · 1000+48/-0hrs.									
12	Thermal Shock *3		Reference standard: IEC 60068-2-14 (2009) [Test Na] · Solder PTC to PCB *2 · Transport time: <3min. · Test condition: See below table <table border="1" style="margin-left: 20px;"> <thead> <tr> <th>Step</th> <th>Condition</th> <th>Soaking Time</th> </tr> </thead> <tbody> <tr> <td>1</td> <td>-55±3°C</td> <td>30min.</td> </tr> <tr> <td>2</td> <td>+125±2°C</td> <td>30min.</td> </tr> </tbody> </table> · Test cycle: 1000 cycles	Step	Condition	Soaking Time	1	-55±3°C	30min.	2	+125±2°C	30min.
Step	Condition	Soaking Time										
1	-55±3°C	30min.										
2	+125±2°C	30min.										
13	High Temperature Load		Reference standard: IEC 60068-2-2 (2007) · Solder PTC to PCB *2 · +125±2°C · Applied max. voltage: 1.5hrs., OFF: 0.5hrs. · 1000+48/-0hrs.									
14	Damp Heat Load		Reference standard: IEC 60068-2-67 (1995) · Solder PTC to PCB *2 · +85±2°C, 85±5%RH · Applied max. voltage · 1000+48/-0hrs.									

*1: The resistance value after the test is measured by 4-terminal method with less than 10mA, after storage in 25±2°C for 2hrs.

*2: Above-mentioned soldering is done following condition at our side.

- Glass epoxy PC board
- Standard land dimension
- Standard solder paste
- Standard solder profile

Above conditions are defined in Notice.

*3: We cannot guarantee the resistance change in Thermal Shock in a case of defective mounting.

POSISTOR Chip Type ⚠Caution/Notice

⚠Caution (Storage and Operating Conditions)

This product is designed for application in an ordinary environment (normal room temperature, humidity and atmospheric pressure). Do not use under the following conditions because all of these factors can deteriorate the characteristics or cause product failure and burn-out.

1. Corrosive gas or deoxidizing gas (Chlorine gas, Hydrogen sulfide gas, Ammonia gas, Sulfuric acid gas, Nitric oxide gas, etc.)
2. Volatile or flammable gas
3. Dusty conditions
4. Under vacuum, or under high or low pressure
5. Wet or humid conditions
6. Places with salt water, oils, chemical liquids or organic solvents
7. Strong vibrations
8. Other places where similar hazardous conditions exist

⚠Caution (Other)

Be sure to provide an appropriate fail-safe function on your product to prevent secondary damage that may be caused by the abnormal function or the failure of our product.

Notice (Storage and Operating Conditions)

To keep solderability of product from declining, the following storage conditions are recommended.

1. Storage condition:
 Temperature -10 to +40°C
 Humidity less than 75%RH (not dewing condition)
2. Storage term:
 Use this product within 6 months after delivery by first-in and first-out stocking system.

3. Storage place:
 Do not store this product in corrosive gas (Sulfuric acid, Chlorine, etc.) or in direct sunlight.

Notice (Handling)

1. Do not give this product a strong press-force or a mechanical shock, because such mechanical forces may cause cracking or chipping of this ceramic product.
2. Rapid cooling or heating during soldering is not recommended such treatment may destroy the element.
3. Resin coating
 Please select a resin material with minimum hardness. The shrinkage of the resin at heat treatment should be much less in order not to apply much stress to the product.
4. Location on Printed Circuit Board (PC Board)
 Choose a mounting position that minimizes the stress imposed on the chip during flexing or bending of the board.

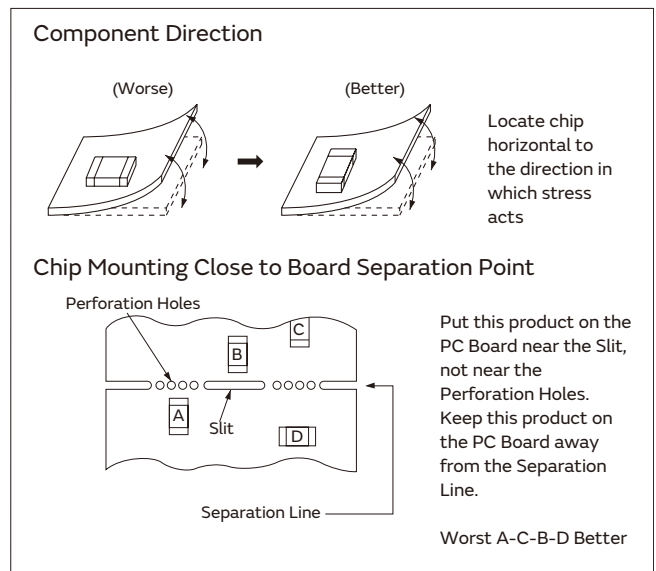

POSISTOR Chip Type ⚠️Caution/Notice

Notice (Soldering and Mounting) PRF18 Series

1. Solder and Flux

(1) Solder Paste

- (a) Flow Soldering: Use Sn:Pb=60:40wt%, Sn:Pb=63:37wt%, Sn:Ag:Cu=96.5:3.0:0.5wt% or equivalent type of solder.
- (b) Reflow Soldering: Use Sn:Pb=60:40wt%, Sn:Pb=63:37wt%, Sn:Ag:Cu=96.5:3.0:0.5wt% or equivalent type of solder paste.
- For your reference, we are using "63Sn/37Pb RMA9086 90-3-M18," manufactured by Alpha Metals Japan Ltd., "96.5Sn/3.0Ag/0.5Cu M705-GRN360-K2-V," manufactured by Senju Metal Industry Co., Ltd. for any internal tests of this product.

(2) Flux

- Use rosin type flux in the soldering process. If the flux below is used, some problems might be caused in the product characteristics and reliability. Please do not use these types of flux.
- Strong acidic flux (with halide content exceeding 0.2wt%).
 - Water-soluble flux (*Water-soluble flux can be defined as non-rosin type flux including wash-type flux and non-wash-type flux.)

2. Cleaning Conditions and Drying

To remove the flux after soldering, observe the following points in order to avoid deterioration of the characteristics or any change to the external electrodes' quality.

(1) Cleaning Conditions

Solvent	Dipping Cleaning	Ultrasonic Cleaning
2-propanol	Less than 5min. at room temp. or Less than 2min. at 40°C max.	Less than 1min. 20W/L Frequency of several 10kHz to 100kHz.

A sufficient cleaning should be applied to remove flux completely.

(2) Drying

After cleaning, promptly dry this product.

3. Soldering Conditions

In your mounting process, observe the following points in order to avoid deterioration of the characteristics or destruction of this product. The mounting quality of this product may also be affected by the mounting conditions, shown in the points below.

(1) Printing Conditions of Solder Paste

- (a) Recommended thickness of solder paste printing should be from 0.15 to 0.20mm.
- (b) After soldering, the solder fillet should be a height from 0.2 mm to the thickness of this product (see the figure at right).
- (c) Too much solder result in excessive mechanical stress on this product. Such stress may cause cracking or other mechanical damage. Also, it can destroy the electrical performance of this product.

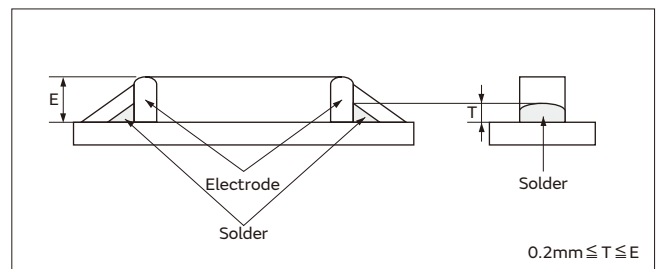

Continued on the following page. ↗

POSISTOR Chip Type ⚠️Caution/Notice

Continued from the preceding page. ↘

(2) Adhesive Application and Curing

- (a) If insufficient adhesive is applied, or if the adhesive is not sufficiently hardened, this product may have a loose contact with the land, during flow soldering.
- (b) Too low viscosity of adhesive causes this product to slip on the board, after mounting.

(3) Allowable Soldering Temperature and Time

- (a) Solder within the temperature and time combinations, indicated by the slanted lines in the following graphs.
- (b) Excessive soldering conditions may cause dissolution of metallization or deterioration of solder-wetting on the external electrode.
- (c) In the case of repeated soldering, the accumulated soldering time should be within the range shown in the figures below. (For example, Reflow peak temperature: 260°C, twice → The accumulated soldering time at 260°C is within 30sec.)

Allowable Flow Soldering Temp. and Time

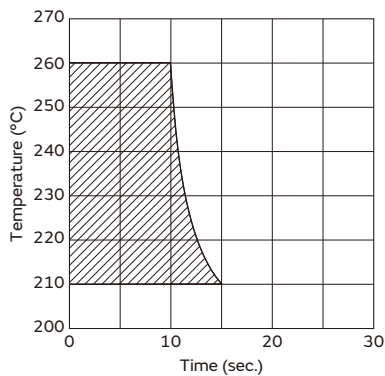

Allowable Reflow Soldering Temp. and Time

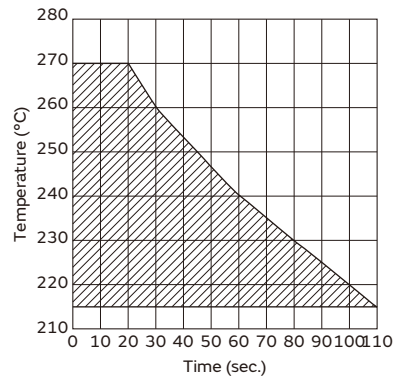

(4) Recommendable Temperature Profile for Soldering

- (a) Insufficient preheating may cause a crack on the ceramic body. The difference between preheating temperature and maximum temperature in the profile should be 100°C.
- (b) Rapid cooling by dipping in solvent or by other means is not recommended.

Flow Soldering Conditions

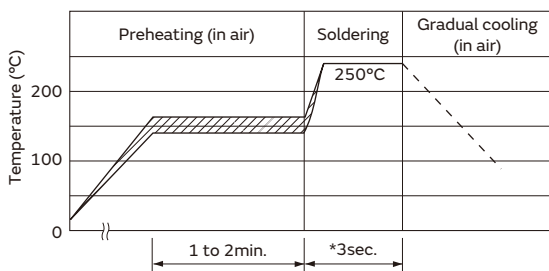

Preheating: 150±10°C, 1-2min.
 Soldering: 250°C, 3sec.

* In the case of repeated soldering, the accumulated soldering time should be within the range shown in "(3) Allowable Soldering Temperature and Time."

Reflow Soldering Conditions

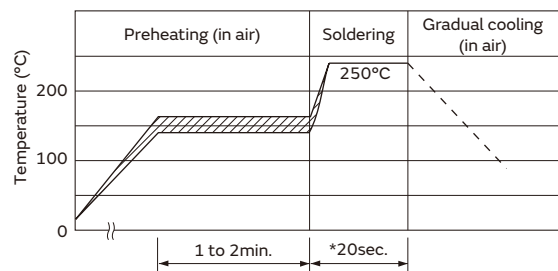

Preheating: 150±10°C, 1-2min.
 Soldering: 250°C, 20sec.

* In the case of repeated soldering, the accumulated soldering time should be within the range shown in "(3) Allowable Soldering Temperature and Time."

- (5) There may be a risk of unexpected failures (tombstone, insufficient solder-wetting, etc.) in the mounting process caused by mounting conditions. Please make sure that this product is correctly mounted under the specified mounting conditions.

POSISTOR Chip Type ⚠Caution/Notice

Notice (Soldering and Mounting) PRG18BB□□□MS1RB

1. Solder and Flux

(1) Solder Paste

Use solder paste Sn:Pb=63:37wt%.
 For your reference, we are using
 63Sn/37Pb RMA9086 90-3-M18,
 manufactured by Alpha Metals Japan Ltd.
 96.5Sn/3.0Ag/0.5Cu M705-GRN360-K2-V,
 manufactured by Senju Metal Industry Co., LTD for any
 internal tests of this product.

(2) Flux

Use rosin type flux in the soldering process.
 If the flux below is used, some problems might be
 caused in the product characteristics and reliability.
 Please do not use these types of flux.
 • Strong acidic flux (with halide content exceeding
 0.2wt%).
 • Water-soluble flux
 (*Water-soluble flux can be defined as non-rosin type
 flux including wash-type flux and non-wash-type flux.)

2. Cleaning Conditions

To remove the flux after soldering, observe the following
 points in order to avoid deterioration of the characteristics
 or any change to the external electrodes' quality.

Solvent	Dipping Cleaning	Ultrasonic Cleaning	Drying
2-propanol	Less than 5min. at room temp. or Less than 2min. at 40°C max.	Less than 1min. 20W/L Frequency of several 10kHz to 100kHz.	After cleaning, promptly dry this product.

A sufficient cleaning should be applied to remove flux completely.

3. Soldering Conditions

In your mounting process, observe the following points in
 order to avoid deterioration of the characteristics or
 destruction of this product. The mounting quality of this
 product may also be affected by the mounting conditions,
 shown in the points below.

This product is for reflow soldering only. Flow soldering
 should not be allowed.

(1) Printing Conditions of Solder Paste

- Standard thickness of solder paste printing should
 be from 0.15 to 0.20 mm.
- After soldering, the solder fillet should be a height
 from 0.2 mm to the thickness of this product (see the
 figure at right).
- Too much solder result in excessive mechanical
 stress to this product. Such stress may cause
 cracking or other mechanical damage. Also, it can
 destroy the electrical performance of this product.

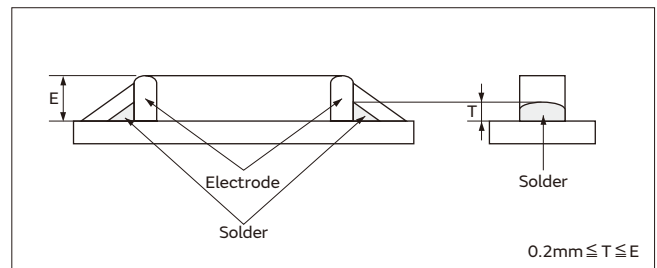

Continued on the following page. ↗

POSISTOR Chip Type ⚠Caution/Notice

Continued from the preceding page. ↘

(2) Allowable Soldering Temperature and Time

- (a) Solder within the temperature and time combinations, indicated by the slanted lines in the graphs at right.
- (b) Excessive soldering conditions may cause dissolution of metallization or deterioration of solder-wetting on the external electrode.
- (c) In the case of repeated soldering, the accumulated soldering time should be within the range shown at right. (For example, Reflow peak temperature: 260°C, twice → The accumulated soldering time at 260°C is within 15sec.)

Allowable Reflow Soldering Temp. and Time

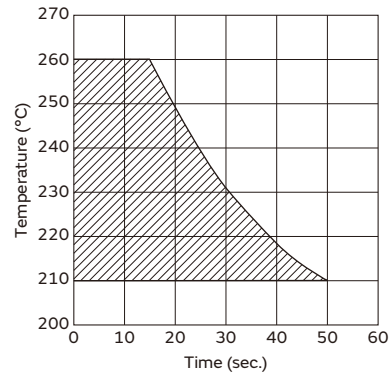

(3) Standard Temperature Profile for Soldering

- (a) Insufficient preheating may cause a crack on the ceramic body. The difference between preheating temperature and maximum temperature in the profile should be 100°C.
- (b) Rapid cooling by dipping in solvent or by other means is not recommended.

Reflow Soldering Conditions

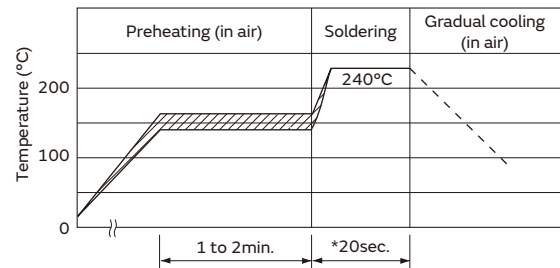

Preheating: 150±10°C, 1 to 2min.
 Soldering: 240°C, 20sec.

* In the case of repeated soldering, the accumulated soldering time should be within the range shown in "(2) Allowable Soldering Temperature and Time."

- (4) There may be a risk of unexpected failures (tombstone, insufficient solder-wetting, etc.) in the mounting process, caused by the mounting conditions. Please make sure that this product is correctly mounted under the specified mounting conditions.

POSISTOR Chip Type ⚠Caution/Notice

Notice (Soldering and Mounting) PRG21□□□□MS5RA

1. Solder and Flux

(1) Solder Paste

Use solder paste Sn:Pb=63:37wt%.
 For your reference, we are using
 63Sn/37Pb RMA9086 90-3-M18,
 manufactured by Alpha Metals Japan Ltd.
 96.5Sn/3.0Ag/0.5Cu M705-GRN360-K2-V,
 manufactured by Senju Metal Industry Co., LTD for any
 internal tests of this product.

(2) Flux

Use rosin type flux in the soldering process.
 If the flux below is used, some problems might be
 caused in the product characteristics and reliability.
 Please do not use these types of flux.
 • Strong acidic flux (with halide content exceeding
 0.2wt%).
 • Water-soluble flux
 (*Water-soluble flux can be defined as non-rosin type
 flux including wash-type flux and non-wash-type flux.)

2. Cleaning Conditions

To remove the flux after soldering, observe the following
 points in order to avoid deterioration of the characteristics
 or any change to the external electrodes' quality.

Solvent	Dipping Cleaning	Ultrasonic Cleaning	Drying
2-propanol	Less than 5min. at room temp. or Less than 2min. at 40°C max.	Less than 1min. 20W/L Frequency of several 10kHz to 100kHz.	After cleaning, promptly dry this product.

A sufficient cleaning should be applied to remove flux completely.

3. Soldering Conditions

In your mounting process, observe the following points in
 order to avoid deterioration of the characteristics or
 destruction of this product. The mounting quality of this
 product may also be affected by the mounting conditions,
 shown in the points below.

This product is for reflow soldering only. Flow soldering
 should not be allowed.

(1) Printing Conditions of Solder Paste

- Standard thickness of solder paste printing should
 be from 0.15 to 0.20 mm.
- After soldering, the solder fillet should be a height
 from 0.20 mm to the thickness of this product (see
 the figure at right).
- Too much solder result in excessive mechanical
 stress on this product. Such stress may cause
 cracking or other mechanical damage. Also, it can
 destroy the electrical performance of this product.

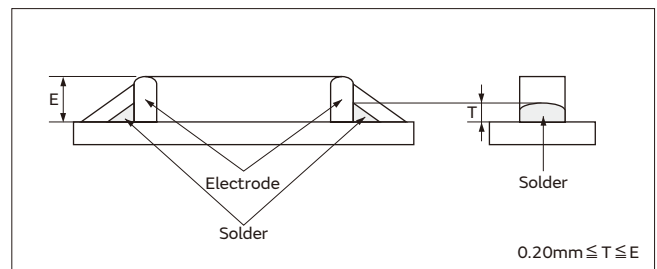

Continued on the following page. ↗

POSISTOR Chip Type ⚠Caution/Notice

Continued from the preceding page. ↘

(2) Reflow soldering conditions

The following figure and table show our recommended reflow profile.

- (a) Insufficient preheating may cause a crack on ceramic body. The temperature difference between preheat and peak should be control within 100°C to prevent this.
- (b) Excessive soldering conditions may cause dissolution of metallization or deterioration of solder-wetting on the external electrode.
- (c) Rapid cooling by dipping in solvent or by other means is not recommended.
- (d) Please evaluate it on your condition if you will do mounting using not applying condition to the above-mentioned.

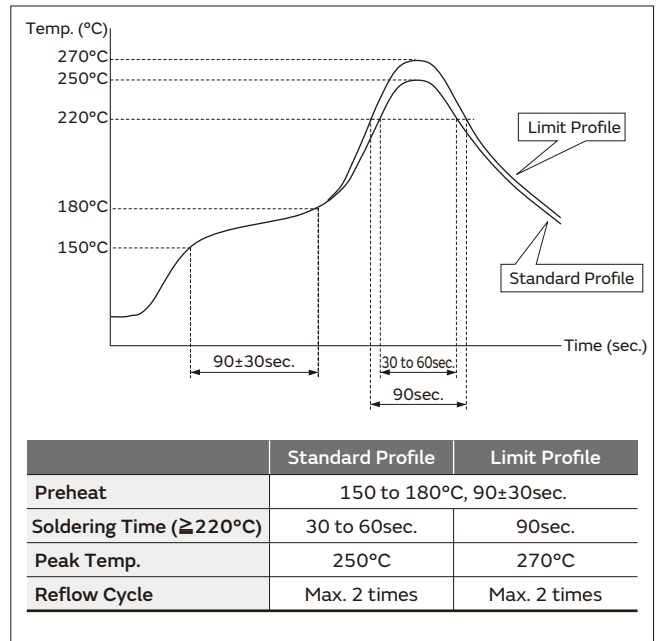

- (3) There may be a risk of unexpected failures (tombstone, insufficient solder-wetting, etc.) in the mounting process, caused by the mounting conditions. Please make sure that this product is correctly mounted under specified mounting conditions.

POSISTOR Chip Type ⚠Caution/Notice

Notice (Soldering and Mounting) PRG21AR□□□MS1R□

1. Solder and Flux

(1) Solder Paste

Use solder paste Sn:Pb=63:37wt%.
 For your reference, we are using
 63Sn/37Pb RMA9086 90-3-M18,
 manufactured by Alpha Metals Japan Ltd.
 96.5Sn/3.0Ag/0.5Cu M705-GRN360-K2-V,
 manufactured by Senju Metal Industry Co., LTD for any
 internal tests of this product.

(2) Flux

Use rosin type flux in the soldering process.
 If the flux below is used, some problems might be
 caused in the product characteristics and reliability.
 Please do not use these types of flux.

- Strong acidic flux (with halide content exceeding 0.2wt%).
- Water-soluble flux
 (*Water-soluble flux can be defined as non-rosin type flux including wash-type flux and non-wash-type flux.)

2. Cleaning Conditions

To remove the flux after soldering, observe the following points in order to avoid deterioration of the characteristics or any change to the external electrodes' quality.

Solvent	Dipping Cleaning	Ultrasonic Cleaning	Drying
2-propanol	Less than 5min. at room temp. or Less than 2min. at 40°C max.	Less than 1min. 20W/L Frequency of several 10kHz to 100kHz.	After cleaning, promptly dry this product.

A sufficient cleaning should be applied to remove flux completely.

3. Soldering Conditions

In your mounting process, observe the following points in order to avoid deterioration of the characteristics or destruction of this product. The mounting quality of this product may also be affected by the mounting conditions, shown in the points below.

This product is for reflow soldering only. Flow soldering should not be allowed.

(1) Printing Conditions of Solder Paste

- (a) Standard thickness of solder paste printing should be from 0.15 to 0.20 mm.
- (b) After soldering, the solder fillet should be a height from 0.2 mm to the thickness of this product (see the figure at right).
- (c) Too much solder result in excessive mechanical stress to this product. Such stress may cause cracking or other mechanical damage. Also, it can destroy the electrical performance of this product.

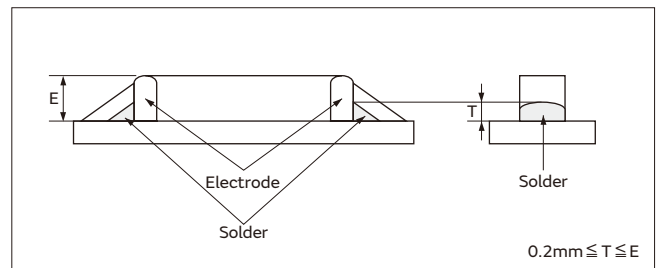

Continued on the following page. ↗

POSISTOR Chip Type ⚠️Caution/Notice

Continued from the preceding page. ↘

(2) Allowable Soldering Temperature and Time

- (a) Solder within the temperature and time combinations, indicated by the slanted lines in the graphs at right.
- (b) Excessive soldering conditions may cause dissolution of metallization or deterioration of solder-wetting on the external electrode.
- (c) In the case of repeated soldering, the accumulated soldering time should be within the range shown at right. (For example, Reflow peak temperature: 260°C, twice → The accumulated soldering time at 260°C is within 15sec.)

Allowable Reflow Soldering Temp. and Time

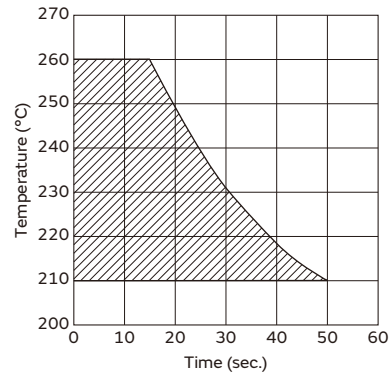

(3) Standard Temperature Profile for Soldering

- (a) Insufficient preheating may cause a crack on the ceramic body. The difference between preheating temperature and maximum temperature in the profile should be 100°C.
- (b) Rapid cooling by dipping in solvent or by other means is not recommended.

Reflow Soldering Conditions

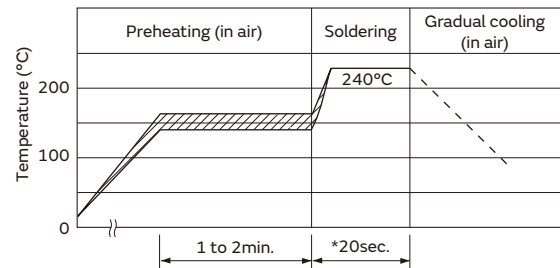

Preheating: 150±10°C, 1 to 2min.
 Soldering: 240°C, 20sec.

* In the case of repeated soldering, the accumulated soldering time should be within the range shown in "(2) Allowable Soldering Temperature and Time."

- (4) There may be a risk of unexpected failures (tombstone, insufficient solder-wetting, etc.) in the mounting process, caused by the mounting conditions. Please make sure that this product is correctly mounted under the specified mounting conditions.

PTC Thermistors (POSISTOR) for Automotive

For Overcurrent Protection Lead Type

16V Series

This low-voltage, low-resistance type "POSISTOR" is a circuit protector whose resistance value in normal operation is very low and in abnormal situations such as motor lock or short circuit, will be increased to restrain over current. This "POSISTOR" is most suitable for low-voltage circuits and motor protection for automotive grade applications.

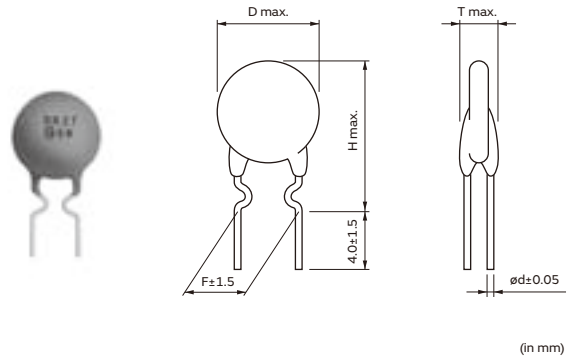

Features

1. Best suited to meet the requirements for power supply and motor protection. Error-free operation is assured by rush current.
2. Circuit is protected until current is turned off.
3. Restores the original low resistance value automatically once the overload is removed.
4. Non-contact design leads to long life and no noise. Durable and strong against mechanical vibration and shock because it is a solid element.
5. Lead (Pb) is not contained in the terminations.

Detailed are accessible from the following URL.
<https://www.murata.com/en-global/products/thermistor/ptc/ptgl>

Part Number	Max. Voltage (V)	Hold Current (mA)		Trip Current (mA)		Max. Current (A)	Resistance (at +25°C) (ohm)	Body Diameter (D) (mm)	Thickness (T) (mm)	Height (H) (mm)	Lead Space (F) (mm)	Lead Diameter (phi d) (mm)
		at +85°C	at +25°C	at +25°C	at -30°C							
PTGL5SAR1R0M1B51B0	16	252	470	880	1095	2.0	1.0 ±20%	6.0	3.5	9.5	5.0	0.6
PTGL6SAR0R8M1B51B0	16	274	505	955	1193	3.0	0.8 ±20%	6.5	3.5	10.0	5.0	0.6
PTGL7SARR47M1B51B0	16	376	705	1310	1634	5.0	0.47 ±20%	7.5	3.5	12.0	5.0	0.6
PTGL9SARR33M1B51B0	16	466	875	1625	2026	7.0	0.33 ±20%	9.0	3.5	14.0	5.0	0.6
PTGLASARR27M1B51B0	16	545	1025	1900	2369	8.0	0.27 ±20%	10.1	3.5	15.0	5.0	0.6
PTGLCSAR0R2M1B51B0	16	692	1300	2410	3006	9.0	0.2 ±20%	11.3	3.5	16.0	5.0	0.6
PTGLESARR15M1B51B0	16	820	1545	2855	3561	10	0.15 ±20%	13.5	3.5	18.5	5.0	0.6

Maximum Current shows typical capacities at which the transformer can be used.

Operating Temperature Range: -30°C to +85°C

Taping type of part numbers with "AO" is available (except PTGLESARR15M1B51B0).

30-140V Series

New leaded type "POSISTOR" for overcurrent protection as automotive grade can be used with a wide temperature range. This product is suitable for short-protection and current limiting resistance on power supply equipment.

Features

1. Useful protective threshold current range with a wide temperature range.
2. Small fluctuation in the circuit due to resistance tolerance +/-10%.
3. Quick operating time due to small size compared with conventional products.
4. Best suited to meet the requirements of power supply and motor protector. Error-free operation is assured by rush current.
5. Circuit is protected until current is turned off.
6. Restores the original low resistance value automatically once the overload is removed.
7. Non-contact design leads to long life and no noise. Durable and strong against mechanical vibration and shock because it is a solid element.
8. Lead (Pb) is not contained in the terminations.

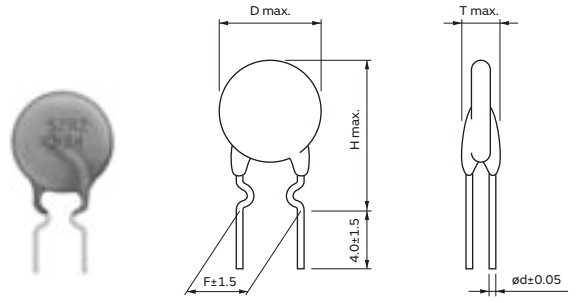

(in mm)

Part Number	Max. Voltage (V)	Hold Current (mA)			Trip Current (mA)		Max. Current (A)	Resistance (at +25°C) (ohm)	Body Diameter (D) (mm)	Thickness (T) (mm)	Height (H) (mm)	Lead Space (F) (mm)	Lead Diameter (phi d) (mm)
		at +105°C	at +85°C	at +25°C	at +25°C	at -40°C							
PTGL4SAS100K2N51B0	30	65	92	154	205	261	1.5	10 ±10%	4.5	3.5	9.5	5.0	0.5
PTGL4SAS100K2B51B0	30	89	127	212	282	359	2.0	10 ±10%	4.5	3.5	9.5	5.0	0.6
PTGL5SAS3R9K2B51B0	30	143	204	340	452	576	3.5	3.9 ±10%	5.5	3.5	10.5	5.0	0.6
PTGL7SAS2R7K2B51B0	30	179	255	425	565	720	4.5	2.7 ±10%	7.3	3.5	12.3	5.0	0.6
PTGL7SAS1R8K2B51B0	30	223	319	532	708	902	5.0	1.8 ±10%	7.3	3.5	12.3	5.0	0.6
PTGL9SAS1R2K2B51B0	30	296	422	704	936	1193	6.0	1.2 ±10%	9.3	3.5	14.3	5.0	0.6
PTGLCSAS0R8K2B51B0	30	364	520	867	1153	1470	7.0	0.8 ±10%	11.5	3.5	16.5	5.0	0.6
PTGL4SAS100K3B51B0	51	89	128	213	283	361	1.0	10 ±10%	4.5	3.5	9.5	5.0	0.6
PTGL5SAS6R8K3B51B0	51	105	149	249	331	422	1.5	6.8 ±10%	5.5	3.5	10.5	5.0	0.6
PTGL7SAS3R3K3B51B0	51	163	233	389	517	659	3.0	3.3 ±10%	7.3	3.5	12.3	5.0	0.6
PTGL9SAS2R2K3B51B0	51	219	313	522	694	885	4.0	2.2 ±10%	9.3	3.5	14.3	5.0	0.6
PTGLCSAS1R2K3B51B0	51	315	449	749	996	1270	5.0	1.2 ±10%	11.5	3.5	16.5	5.0	0.6
PTGL4SAS220K4N51B0	60	47	67	112	149	190	1.0	22 ±10%	4.5	3.5	9.5	5.0	0.5
PTGL4SAS220K4B51B0	60	61	87	145	193	246	1.0	22 ±10%	4.5	3.5	9.5	5.0	0.6
PTGL5SAS100K4B51B0	60	90	129	215	286	364	1.5	10 ±10%	5.5	3.5	10.5	5.0	0.6
PTGL7SAS5R6K4N51B0	60	99	142	236	314	400	2.2	5.6 ±10%	7.3	3.5	12.3	5.0	0.5
PTGL7SAS5R6K4B51B0	60	122	174	290	386	492	3.0	5.6 ±10%	7.3	3.5	12.3	5.0	0.6
PTGL9SAS3R3K4B51B0	60	177	253	421	560	714	4.0	3.3 ±10%	9.3	3.5	14.3	5.0	0.6
PTGLCSAS2R2K4B51B0	60	234	334	556	739	942	5.0	2.2 ±10%	11.5	3.5	16.5	5.0	0.6
PTGL4SAS560K6B51B0	140	39	56	94	125	159	0.5	56 ±10%	4.5	4.5	9.5	5.0	0.6
PTGL5SAS270K6B51B0	140	56	80	134	178	227	1.0	27 ±10%	5.5	4.5	10.5	5.0	0.6
PTGL7SAS150K6B51B0	140	79	112	187	249	317	1.5	15 ±10%	7.3	4.5	12.3	5.0	0.6
PTGL9SAS120K6B51B0	140	102	146	244	324	413	2.0	12 ±10%	9.3	4.5	14.3	5.0	0.6
PTGL9SAS7R6K6B51B0	140	121	172	287	382	486	2.2	7.6 ±10%	9.3	4.5	14.3	5.0	0.6
PTGLCSAS4R7K6B51B0	140	165	236	393	523	666	3.5	4.7 ±10%	11.5	4.5	16.5	5.0	0.6

Maximum Current shows typical capacities at which the transformer can be used.

Operating Temperature Range: -30°C to +125°C

Taping type of part numbers with "AO" is available.

Protective Threshold Current Range (16V Series)

PTGL5SAR1R0M1B51B0

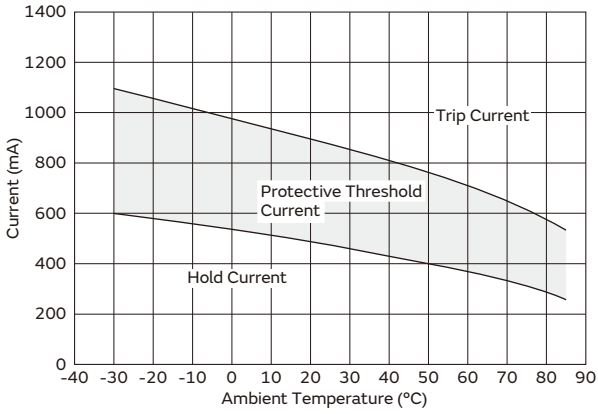

PTGL6SAR0R8M1B51B0

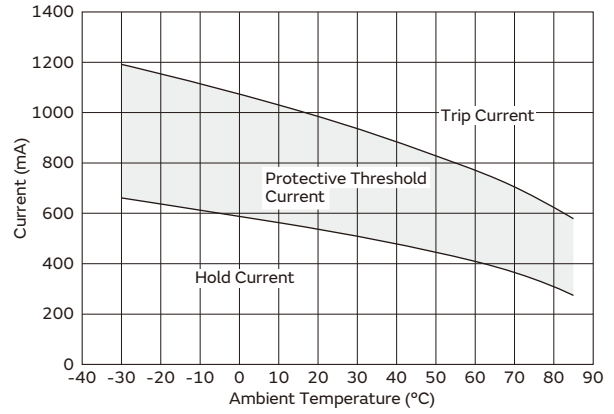

PTGL7SARR47M1B51B0

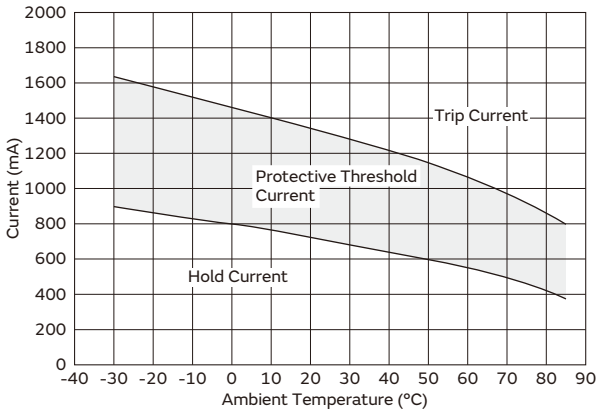

PTGL9SARR33M1B51B0

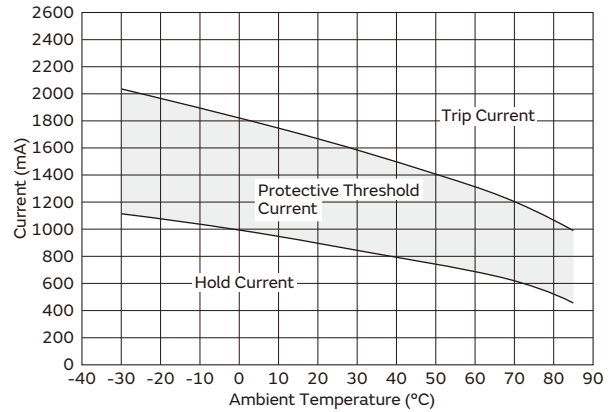

PTGLASARR27M1B51B0

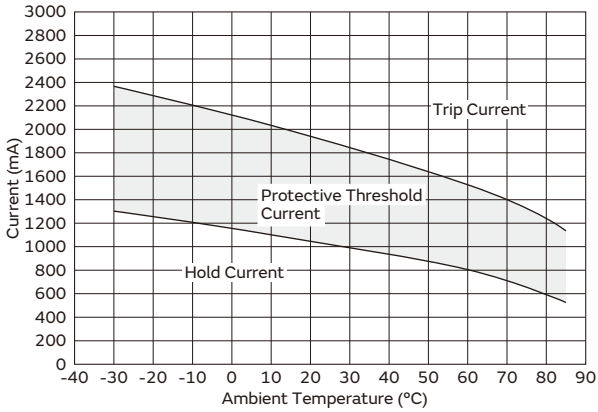

PTGLCSAR0R2M1B51B0

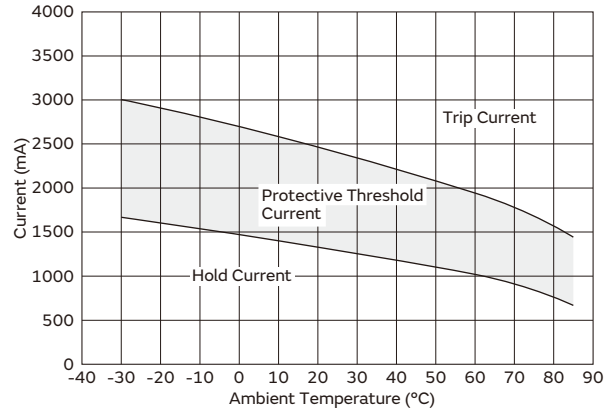

Protective Threshold Current Range (30V Series)

PTGLESARR15M1B51B0

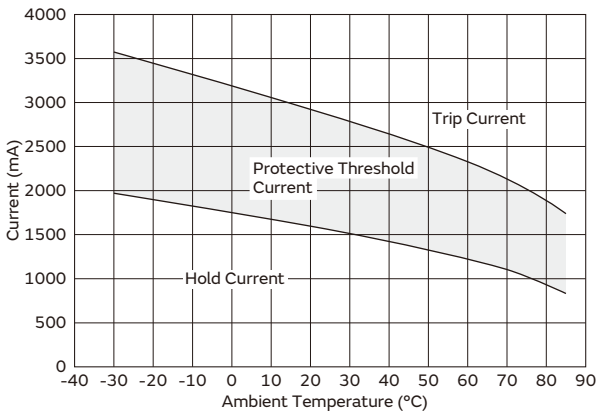

PTGL4SAS100K2N51B0

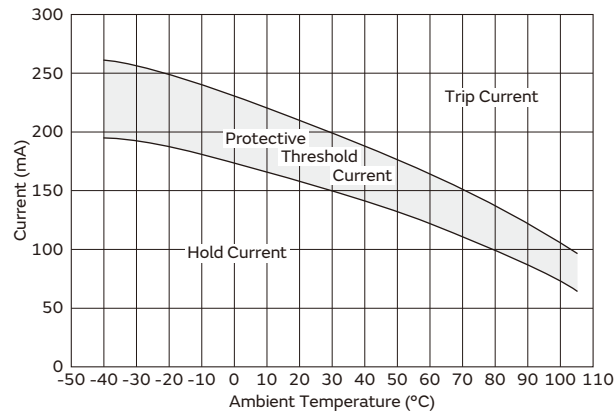

Continued on the following page. ↗

Continued from the preceding page. ↘

Protective Threshold Current Range (30V Series)

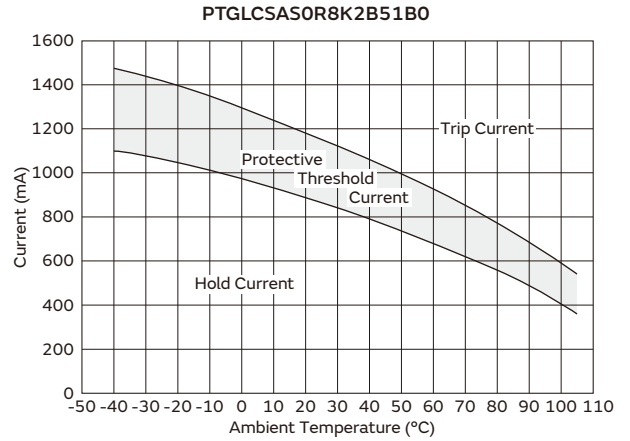
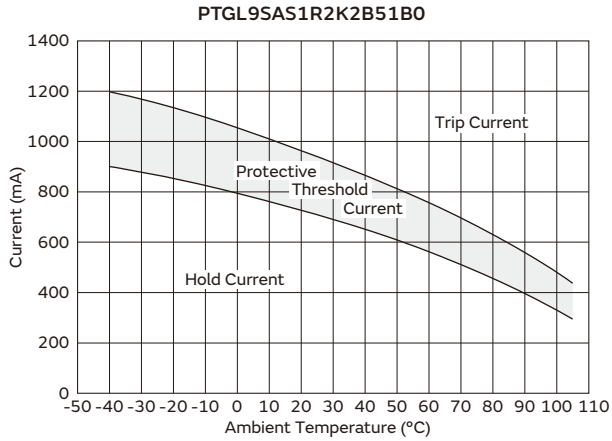
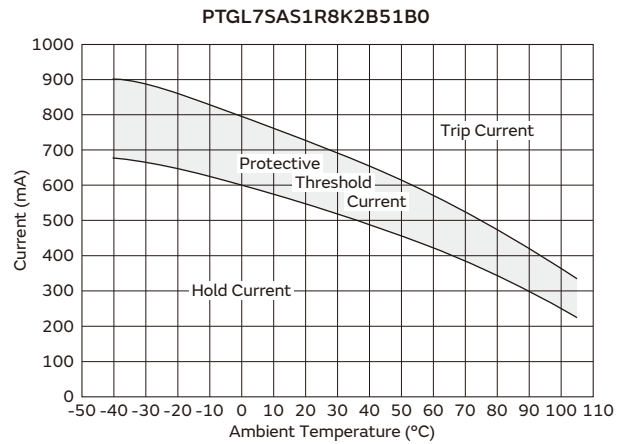
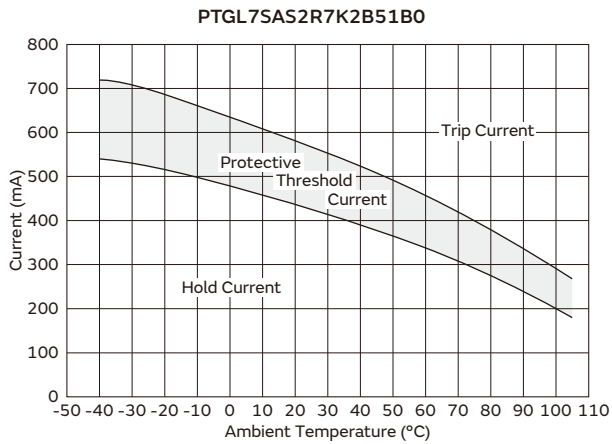
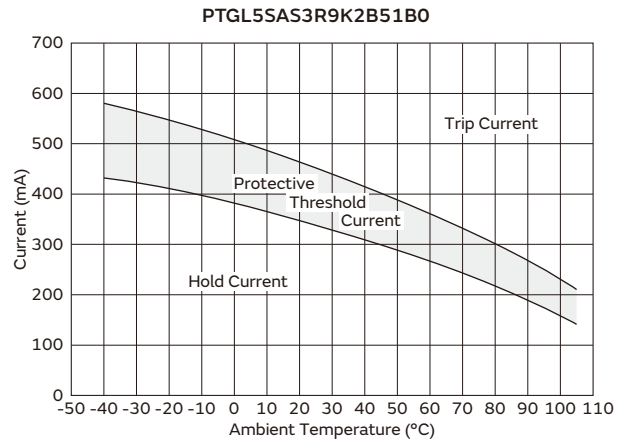
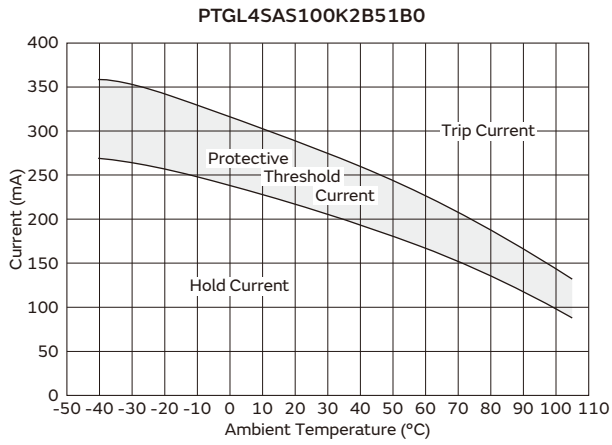

Protective Threshold Current Range (51V Series)

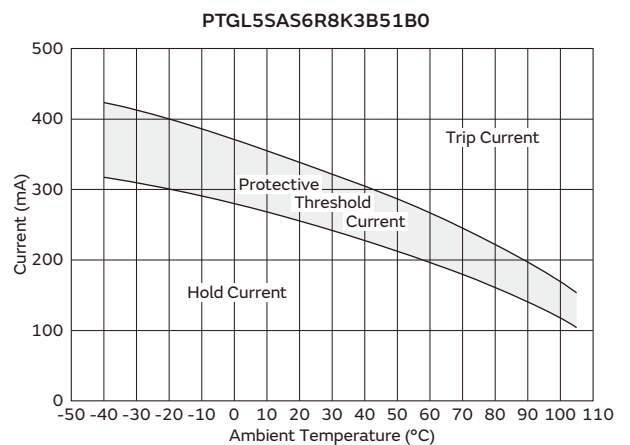
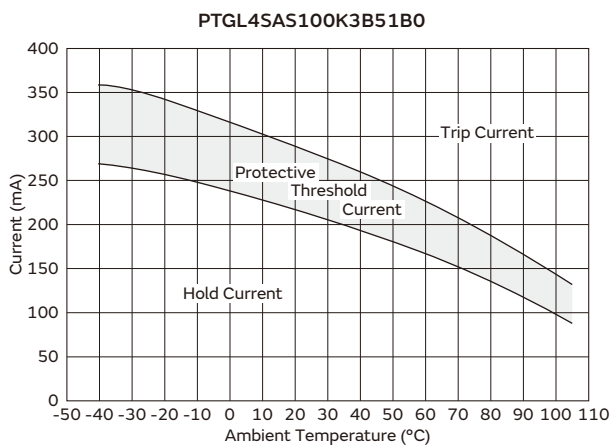

Continued on the following page. ↗

10

70

Continued from the preceding page. ↘

Protective Threshold Current Range (51V Series)

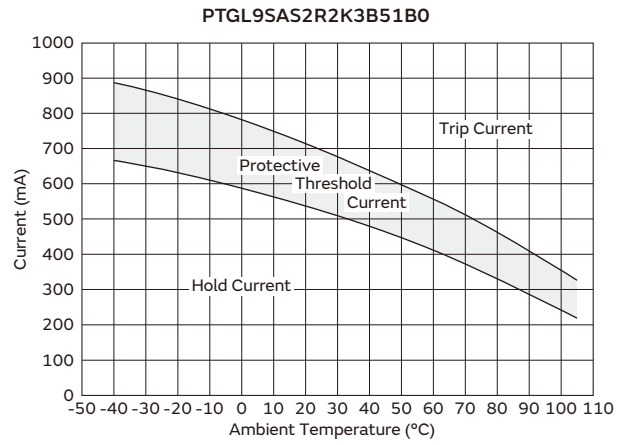
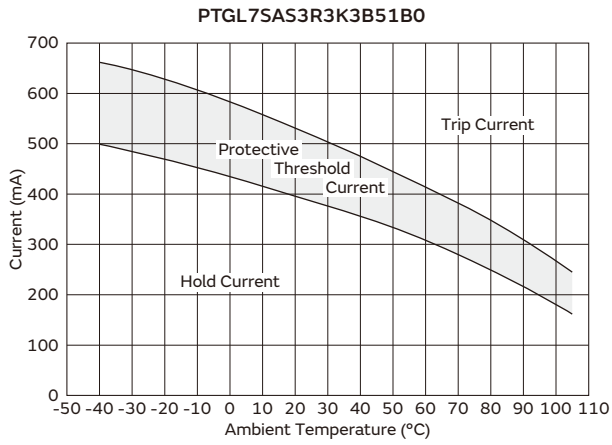

Protective Threshold Current Range (60V Series)

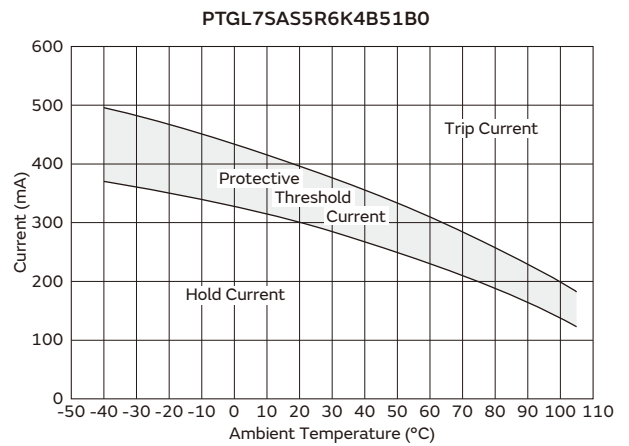
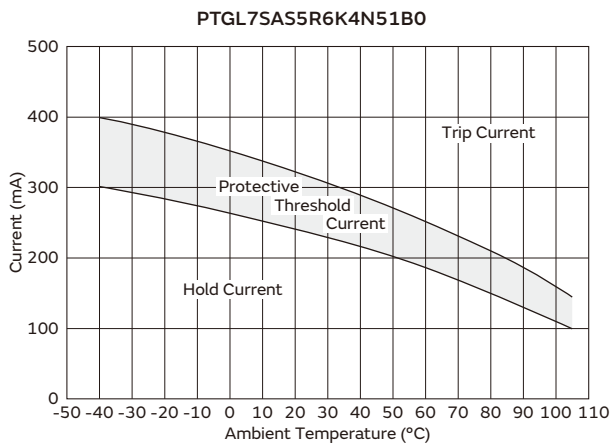
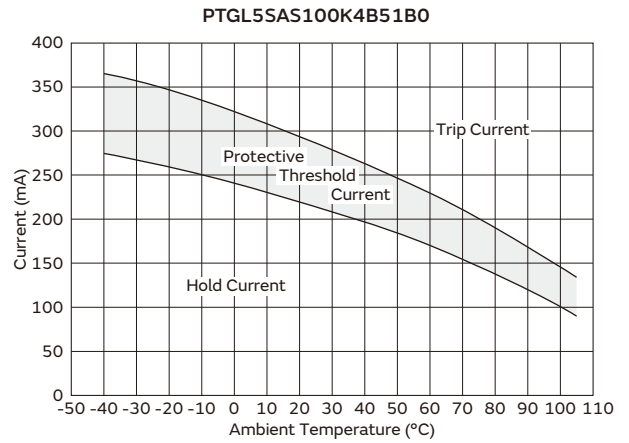
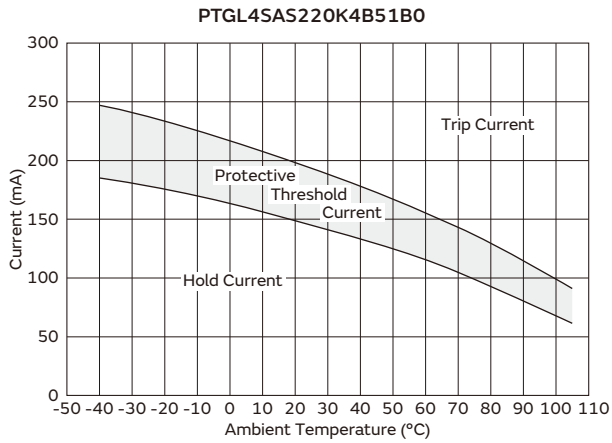
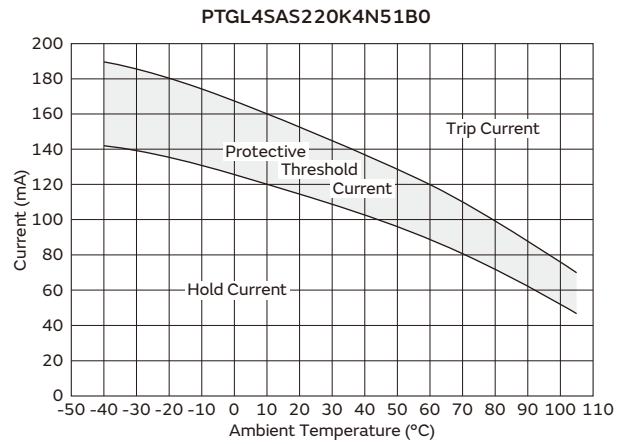
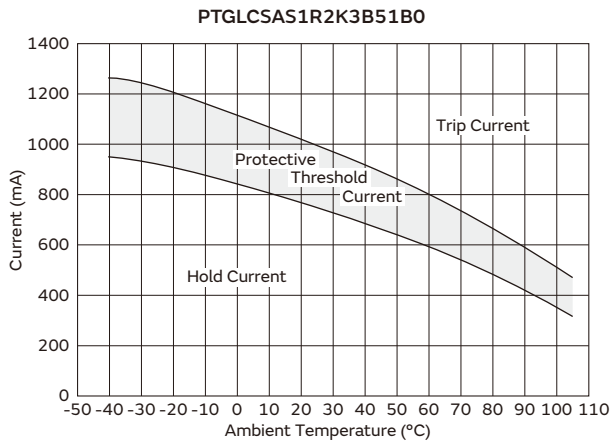

Continued on the following page. ↗

Continued from the preceding page. ↘

Protective Threshold Current Range (60V Series)

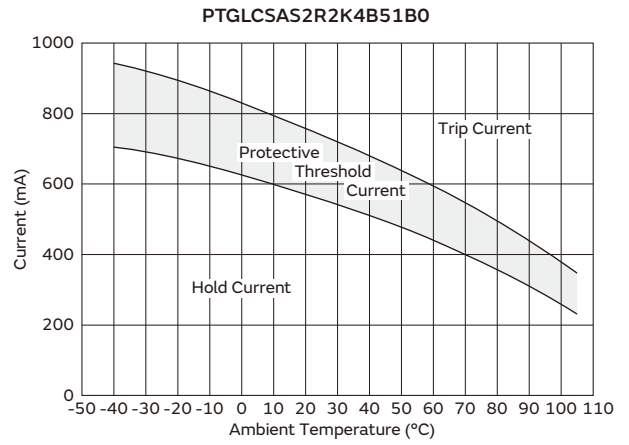
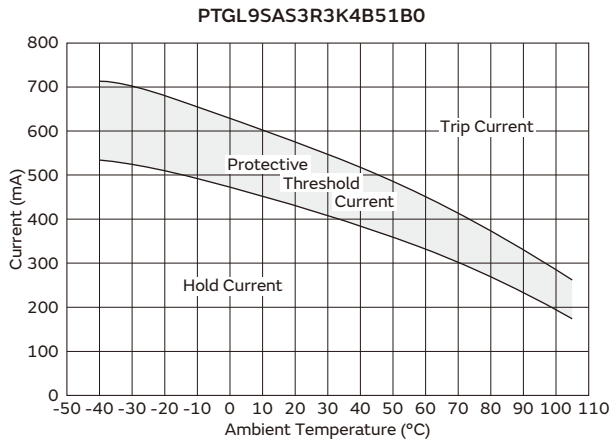

Protective Threshold Current Range (140V Series)

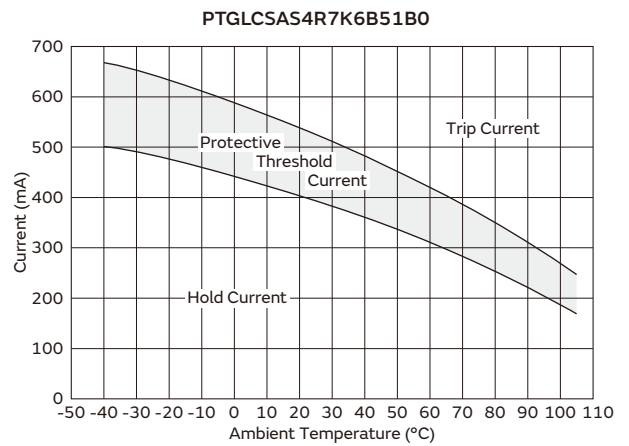
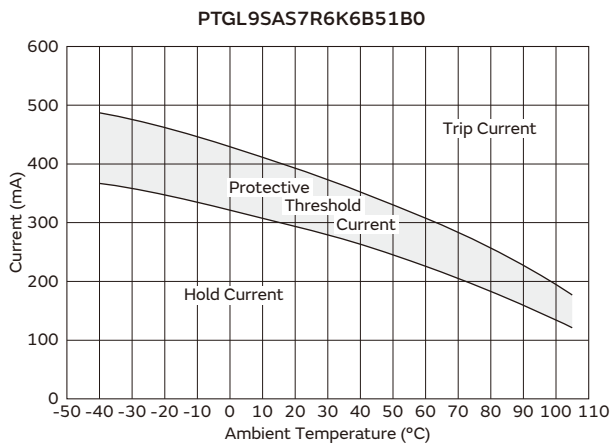
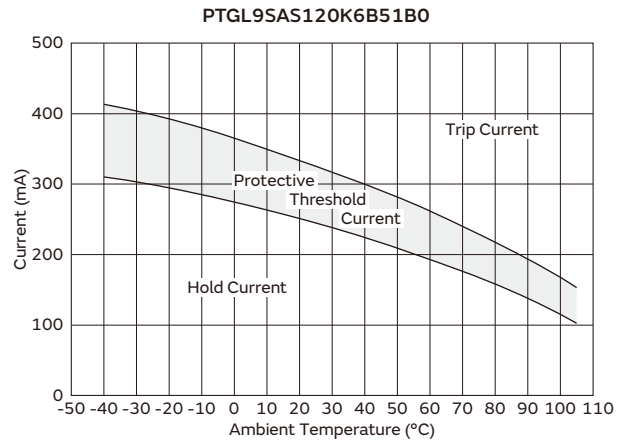
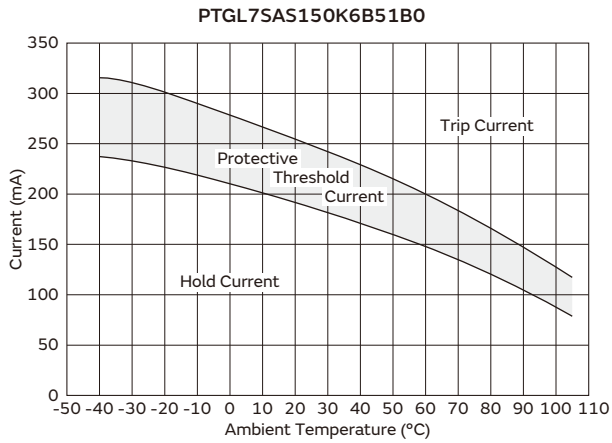
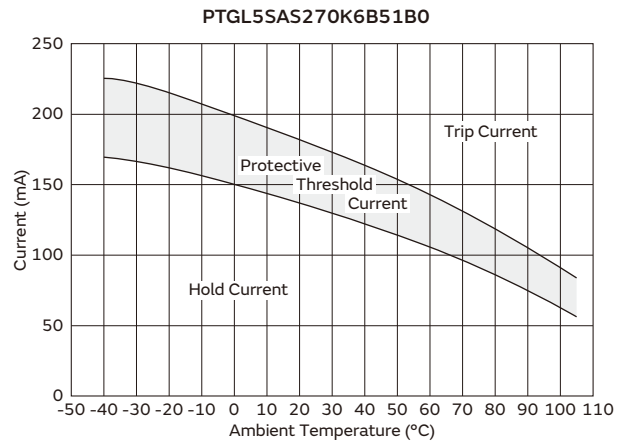
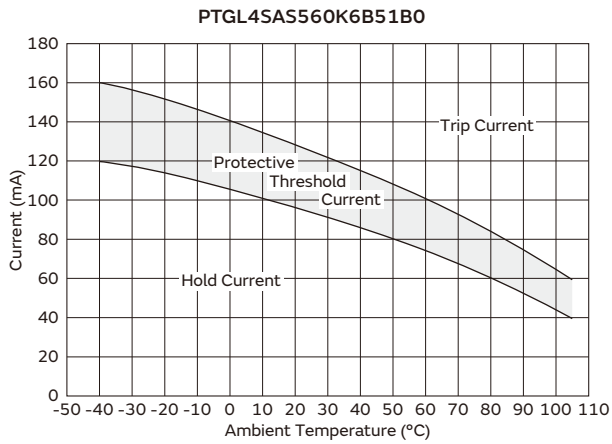

Operating Time (Typical Curve) (16V Series)

PTGL5SAR1R0M1B51B0

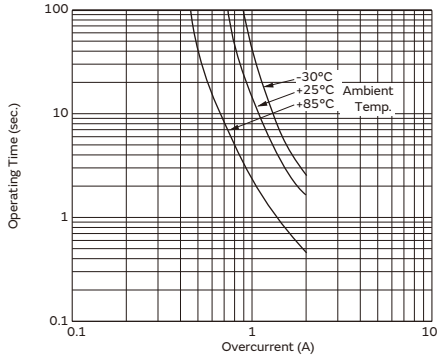

PTGL6SAR0R8M1B51B0

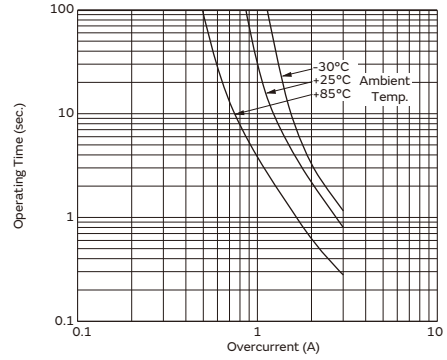

PTGL7SARR47M1B51B0

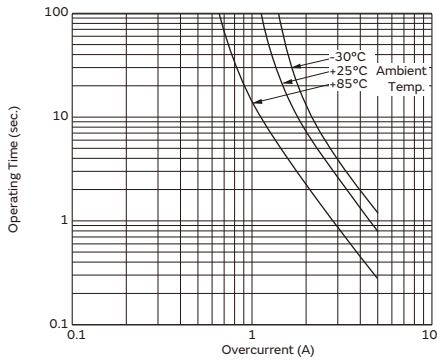

PTGL9SARR33M1B51B0

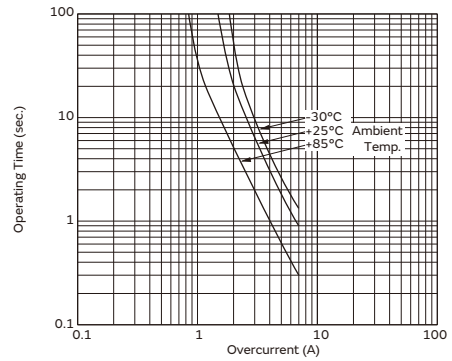

PTGLASARR27M1B51B0

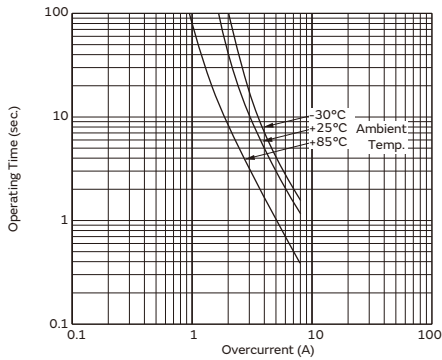

PTGLCSAR0R2M1B51B0

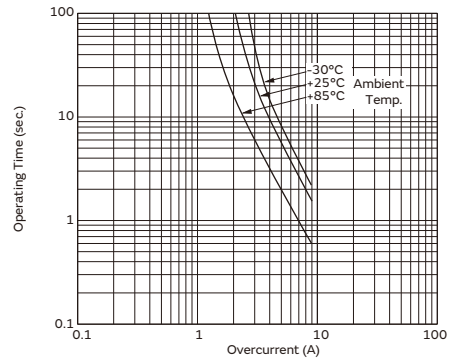

Operating Time (Typical Curve) (30V Series)

PTGLESARR15M1B51B0

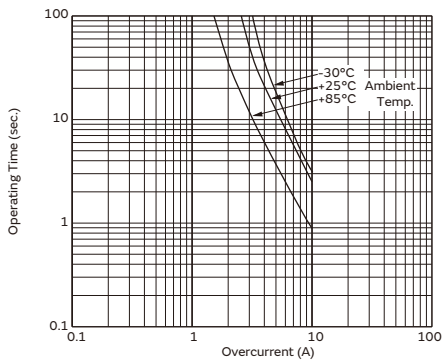

PTGL4SAS100K2N51B0

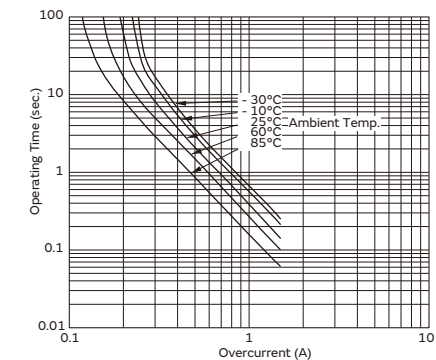

Continued on the following page. ↗

Continued from the preceding page. ↘

Operating Time (Typical Curve) (30V Series)

PTGL4SAS100K2B51B0

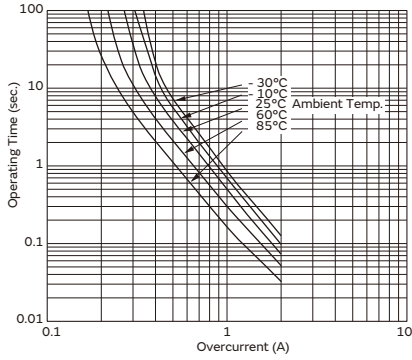

PTGL5SAS3R9K2B51B0

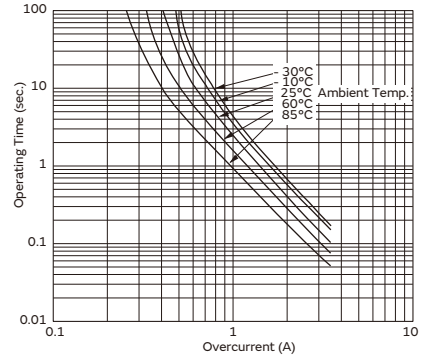

PTGL7SAS2R7K2B51B0

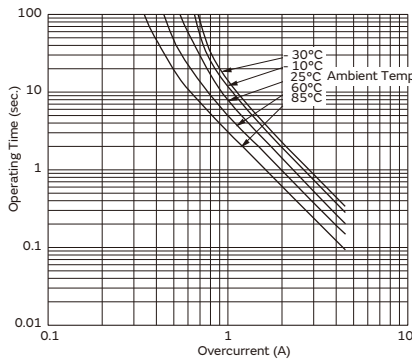

PTGL7SAS1R8K2B51B0

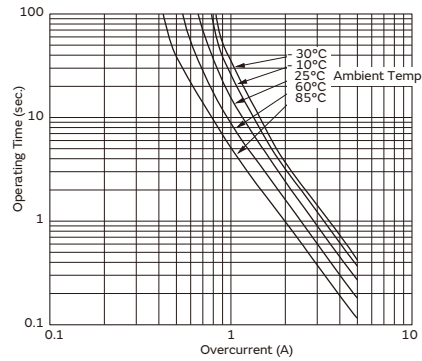

PTGL9SAS1R2K2B51B0

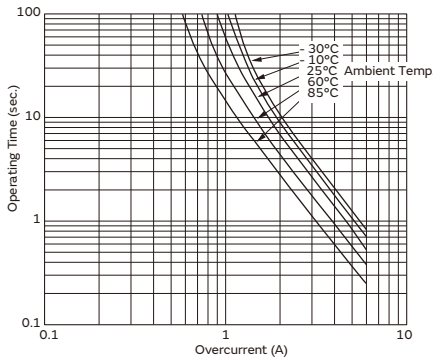

PTGLCSAS0R8K2B51B0

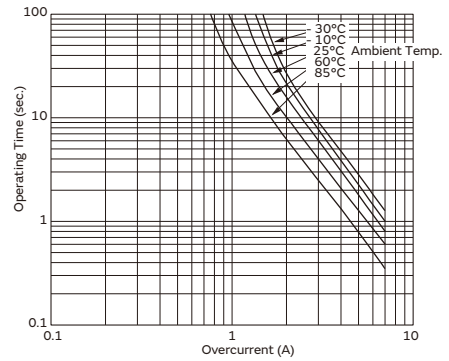

Operating Time (Typical Curve) (51V Series)

PTGL4SAS100K3B51B0

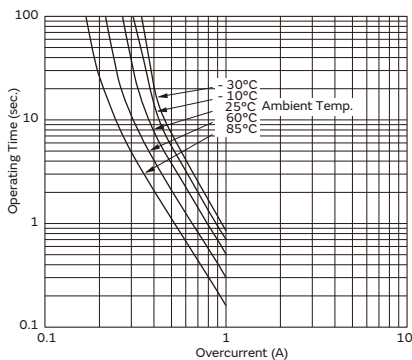

PTGL5SAS6R8K3B51B0

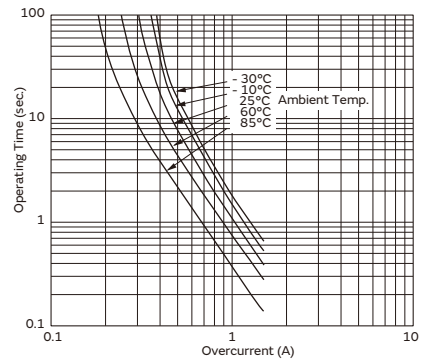

Continued on the following page. ↗

Continued from the preceding page. ↘

Operating Time (Typical Curve) (51V Series)

PTGL7SAS3R3K3B51B0

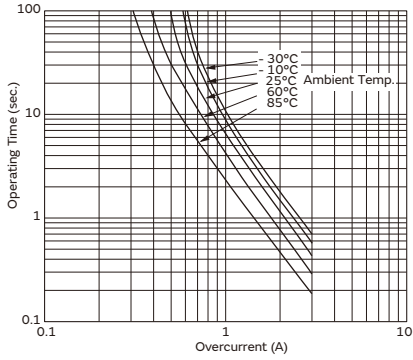

PTGL9SAS2R2K3B51B0

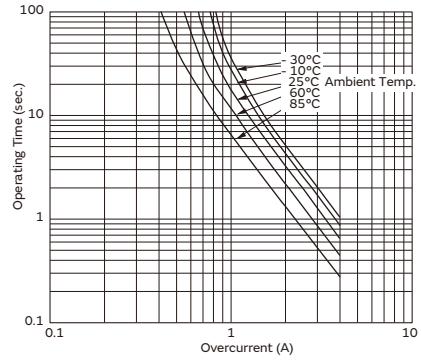

Operating Time (Typical Curve) (60V Series)

PTGLCSAS1R2K3B51B0

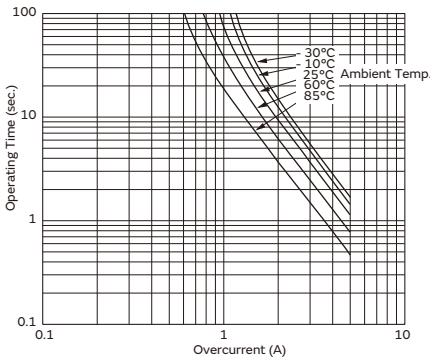

PTGL4SAS220K4N51B0

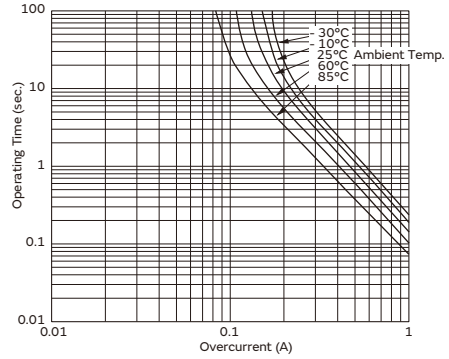

PTGL4SAS220K4B51B0

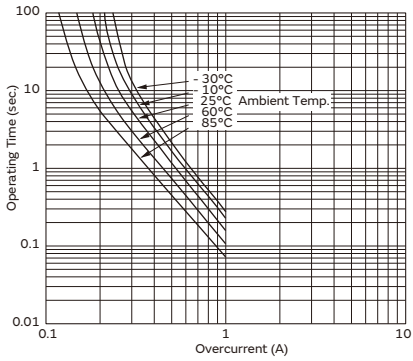

PTGL5SAS100K4B51B0

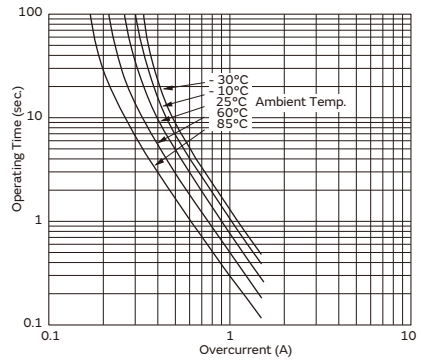

PTGL7SAS5R6K4N51B0

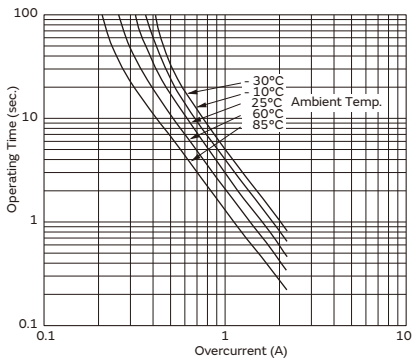

PTGL7SAS5R6K4B51B0

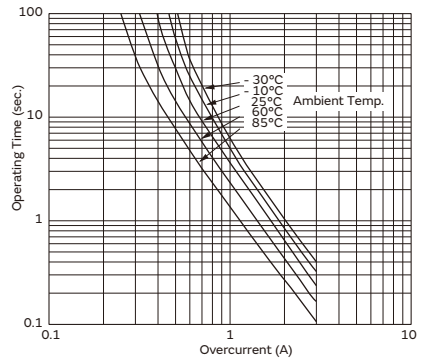

Continued on the following page. ↗

Continued from the preceding page. ↘

Operating Time (Typical Curve) (60V Series)

PTGL9SAS3R3K4B51B0

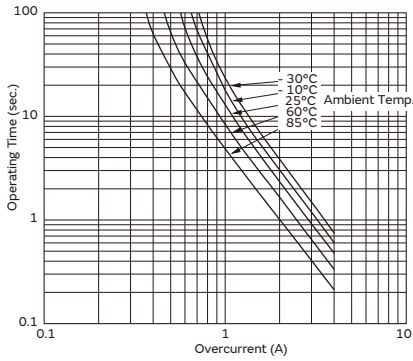

PTGLCSAS2R2K4B51B0

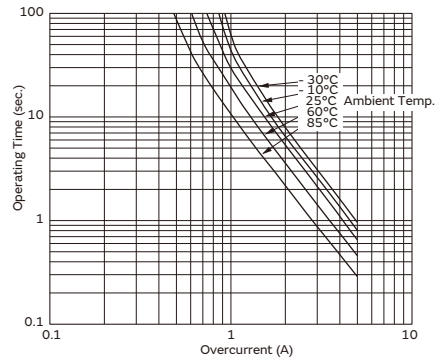

Operating Time (Typical Curve) (140V Series)

PTGL4SAS560K6B51B0

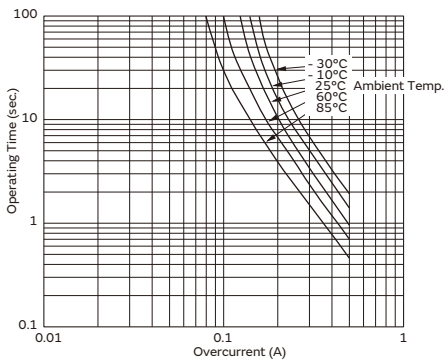

PTGL5SAS270K6B51B0

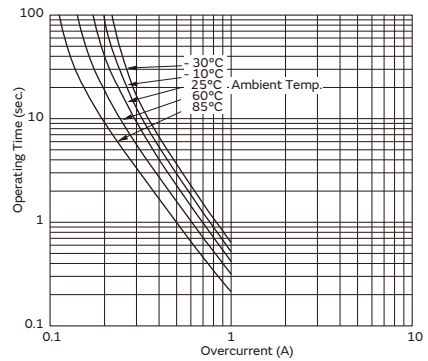

PTGL7SAS150K6B51B0

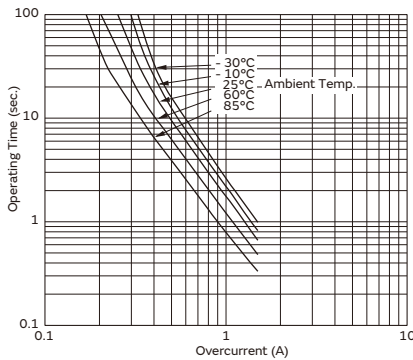

PTGL9SAS120K6B51B0

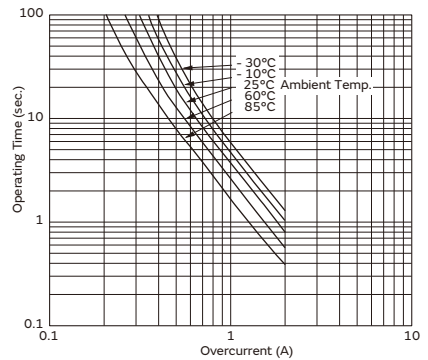

PTGL9SAS7R6K6B51B0

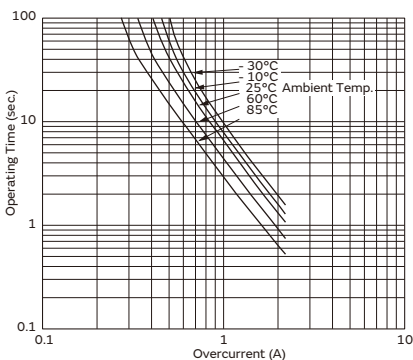

PTGLCSAS4R7K6B51B0

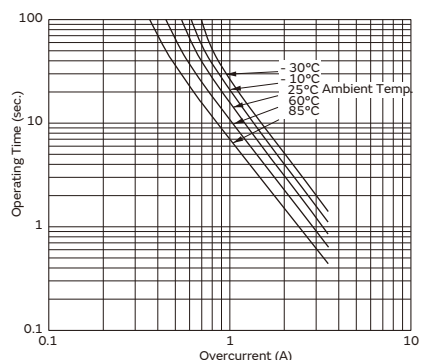

POSISTOR Lead Type for Overcurrent Protection Specifications and Test Methods

16V Series

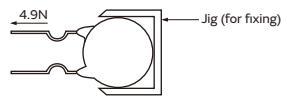
No.	Item	Rating Value	Method of Examination
1	Operating Temperature	-30 to +85°C	The temperature range with maximum voltage applied to the POSISTOR.
2	Storage Temperature Range after Mounting	-40 to +85°C	The storage temperature range in which the POSISTOR can be stored in the implementation state.
3	Resistance (R25)	Satisfies specification	Resistance value is measured by applying voltage under 1.5Vdc (by a direct current of less than 10mA) at 25°C. (But it must be measured after maximum voltage is applied 180sec. and then is left for 2hrs. at 25°C.)
4	Withstanding Voltage	No damage	We apply AC voltage 110% that of the maximum voltage to POSISTOR by raising voltage gradually for 180±5sec. at 25°C. (A protective resistor is to be connected in series, and the inrush current through POSISTOR must be limited below maximum rated value.)
5	Protective Threshold Current	Satisfies ratings (Trip Current, Non-operating Current)	Maximum current is measured in this examination. Voltage is applied to POSISTOR in 3-min. steps still air. Stable current is measured at each step.
6	Tensile Strength of Lead Wire Terminal	No damage	The load is gradually applied to each terminal of POSISTOR until the force of 4.9N in the axial direction with fixing POSISTOR's body itself by a jig and this load is being kept for 10sec. 
7	Bending Strength of Lead Wire Terminal	Lead wire does not come off	POSISTOR is held so that it is perpendicular to the lead wire with 2.45N in the axial direction of the lead wire. The lead wire is slowly bent to 90° and returned; then it is slowly bent in the opposite direction and returned to original state.
8	Solderability	Solder is applied around the lead wire covering 3/4 or more of the circumference without a gap in the axial direction.	The lead wire of POSISTOR is soaked in an Isopropyl Alcohol (JIS K 8839) solution (about 25wt%) of colophony (JIS K 5902) for 5-10sec. Then, each lead wire is soaked in molten solder (JIS Z 3282 H60A) at 235±5°C from the bottom to a point of 2.0-2.5mm for 2±0.5sec.
9	Terminal Durability of Soldering	$\Delta R/R25 \leq \pm 15\%$	The lead wire of POSISTOR is soaked in molten solder (JIS Z 3282 H60A) at 350±10°C from the bottom to a point of 2.0-2.5mm for 3.5±0.5sec. After the device is left at room temperature (25°C) for 24±4hrs., the resistance is measured.
10	Heat Resistant	$\Delta R/R25 \leq \pm 20\%$ No damage about marking	In an 85±3°C chamber, POSISTOR is applied max. voltage for 1.5hrs. on and 0.5hrs. off. This cycle is repeated for 500±10hrs., and after the device is left at room temperature (25°C) for 1hr., the resistance measurement is performed. (A protective resistance is to be connected in series and the inrush current through POSISTOR must be limited below max. rated value.)
11	Resistance to Damp Heat	$\Delta R/R25 \leq \pm 20\%$ No damage about marking	POSISTOR is set in an environmental chamber at 40±2°C and 90% to 95% humidity, for 500±4hrs. Then, after the device is left at room temperature (25°C) for 1hr., the resistance measurement is performed.

POSISTOR Lead Type for Overcurrent Protection Specifications and Test Methods

30-140V Series

No.	Item	Rating Value	Method of Examination
1	Operating Temperature	-30 to +125°C	The temperature range with maximum voltage applied to the POSISTOR.
		-40 to +125°C	The temperature range with the following voltage applied to the POSISTOR. <applied voltage> 30V and 51V series: max. 16V, 60V series: max. 30V, 140V series: max. 140V
2	Storage Temperature Range after Mounting	-40 to +125°C	The storage temperature range in which the POSISTOR can be stored in the implementation state.
3	Resistance (R25)	Satisfies ratings	Resistance value is measured by applying voltage under 1.0Vdc (by a direct current of less than 10mA) at 25°C. (But it must be measured after it is applied maximum voltage for 180sec. and then is left for 2hrs. at 25°C.)
4	Withstanding Voltage	No damage	We apply AC voltage 120% that of the maximum voltage to POSISTOR by raising voltage gradually for 180±5sec. at 25°C. (A protective resistor is to be connected in series, and the inrush current through POSISTOR must be limited below max. rated value.)
5	Protective Threshold Current	Satisfies ratings (Trip Current, Non-operating Current)	Maximum current is measured in this examination. Voltage is applied to POSISTOR in 3-min. steps still air based on "Protective Threshold Current Test Conditions" shown in next page. Stable current is measured at each step.
6	Tensile Strength of Lead Wire Terminal	No damage	The load is gradually applied to each terminal of POSISTOR until the force of 4.9N in the axial direction with fixing POSISTOR's body itself by a jig and this load is being kept for 10sec. 
7	Bending Strength of Lead Wire Terminal	Lead wire does not come off	POSISTOR is held so that it is perpendicular to the lead wire with 2.45N in the axial direction of the lead wire. The lead wire is slowly bent to 90° and returned; then it is slowly bent in the opposite direction and returned to original state.
8	Solderability	Solder is applied around the lead wire covering 3/4 or more of the circumference without a gap in the axial direction.	The lead wire of POSISTOR is soaked in an Isopropyl Alcohol (JIS K 8839) solution (about 25wt%) of colophony (JIS K 5902) for 5-10sec. Then, each lead wire is soaked in molten solder (JIS Z 3282 H60A) at 235±5°C from the bottom to a point of 2.0-2.5mm for 2±0.5sec.
9	Terminal Durability of Soldering	$\Delta R/R25 \leq \pm 15\%$	The lead wire of POSISTOR is soaked in molten solder (JIS Z 3282 H60A) at 350±10°C from the bottom to a point of 2.0-2.5mm for 3.5±0.5sec. After the device is left at room temperature (25°C) for 24±4hrs., the resistance is measured.
10	Vibration Resistant	$\Delta R/R25 \leq \pm 20\%$	Acceleration: 98m/s ² (10G) Width: 1.5mm Vibration: 10-500-10Hz Vibrate for 11min. x 24 cycles in each of 3 mutually perpendicular planes for a total of 13.5hrs.
11	Heat Resistant	$\Delta R/R25 \leq \pm 20\%$	POSISTOR is set in an environmental chamber at 125±3°C for 1000±12hrs. After the device is left at room temperature (25°C) for 1hr., the resistance measurement is performed.
12	Cold Resistant	$\Delta R/R25 \leq \pm 20\%$	POSISTOR is set in an environmental chamber at -40±3°C for 1000±12hrs. After the device is left at room temperature (25°C) for 1hr., the resistance measurement is performed.
13	Resistance to Damp Heat	$\Delta R/R25 \leq \pm 20\%$	POSISTOR is set in an environmental chamber at 85±3°C and 80-85% humidity for 1000±12hrs. After the device is left at room temperature (25°C) for 1hr., the resistance measurement is performed.

Continued on the following page. ↗

POSISTOR Lead Type for Overcurrent Protection Specifications and Test Methods

Continued from the preceding page. ↘

Protective Threshold Current Test Conditions

(1) Substrate

- Materials: Phenol
- Size: 50x50x1.6mm
- Land Pattern: Cu land without through hole

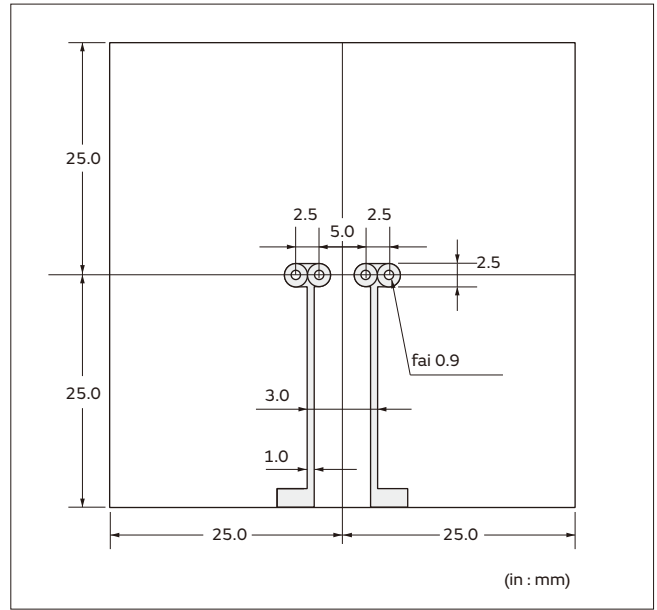

(2) Measurement condition

Solder POSISTOR on the substrate, then put a 150mm³ cover surrounding POSISTOR to prevent airflow.

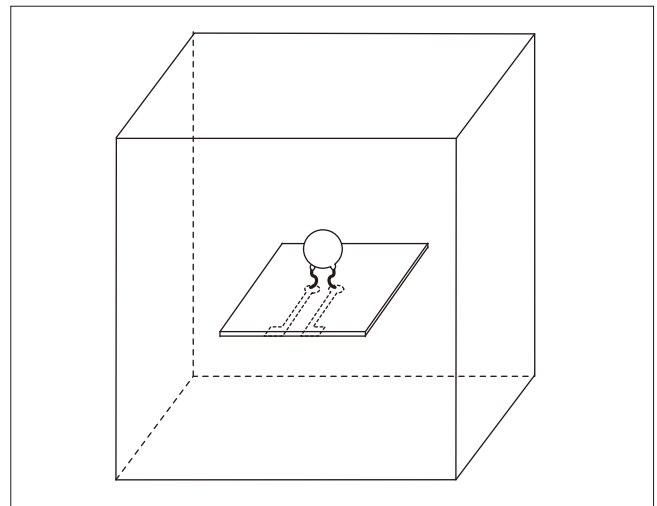

(3) Measurement circuit

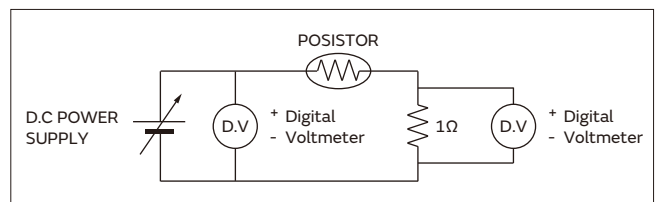

POSISTOR Lead Type for Overcurrent Protection ⚠Caution/Notice

⚠Caution (Storage and Operating Conditions)

This product is designed for application in an ordinary environment (normal room temperature, humidity and atmospheric pressure). Do not use under the following conditions because all of these factors can deteriorate the characteristics or cause product failure and burn-out.

1. Corrosive gas or deoxidizing gas (Chlorine gas, Hydrogen sulfide gas, Ammonia gas, Sulfuric acid gas, Nitric oxide gas, etc.)
2. Volatile or flammable gas
3. Dusty conditions
4. Under vacuum, or under high or low pressure
5. Wet or humid conditions
6. Places with salt water, oils, chemical liquids or organic solvents
7. Strong vibrations
8. Other places where similar hazardous conditions exist

⚠Caution (Other)

Be sure to provide an appropriate fail-safe function on your product to prevent secondary damage that may be caused by the abnormal function or the failure of our product.

Notice (Storage and Operating Conditions)

To keep solderability of product from declining, the following storage conditions are recommended.

1. Storage condition:
 - Temperature -10 to +40°C
 - Humidity less than 75%RH (not dewing condition)
2. Storage term:
 - Use this product within 6 months after delivery by first-in and first-out stocking system.
3. Handling after unpacking:
 - After unpacking, promptly reseal this product or store it in a sealed container with a drying agent.
4. Storage place:
 - Do not store this product in corrosive gas (Sulfuric acid, Chlorine, etc.) or in direct sunlight.

Notice (Soldering and Mounting)

When the lead of this product is soldered, observe the following points to avoid the decline of element characteristics or break-down of the element.

1. Use rosin type flux or non-activated flux
2. Do not dip the body into flux (flux should be coated to lead wire only for soldering).
3. Be sure that preheating does not melt the soldering of this product.

Notice (Handling)

1. Do not apply an excessive force to the lead. Otherwise, it may cause the junction between lead and element to break, or may crack the element. Therefore, holding the element side lead wire is recommended when lead wire is bent or cut.
2. This product does not have waterproof construction. Splashed water may cause failure mode such as decline of characteristics or current leak.
3. When this product is operated, the temperature of some areas may be over 100 to 160°C. Be sure that surrounding parts and inserting material can withstand the temperature. If the surrounding part and material are kept under such conditions, they may deteriorate or produce harmful gas (Chlorine gas, Hydrogen sulfide gas, Ammonia gas, Sulfuric acid gas, Nitric oxide gas, etc.), and such harmful gas may deteriorate the element.

POSISTOR Chip Type Package

Minimum Quantity Guide

Part Number	Quantity (pcs.)	
	Paper Tape	Embossed Tape
PR□18_RB	4,000	-
PR□21_RA	-	4,000
PRG21_RK	-	3,000

Tape Dimensions

PR□18_RB Series: Paper Tape

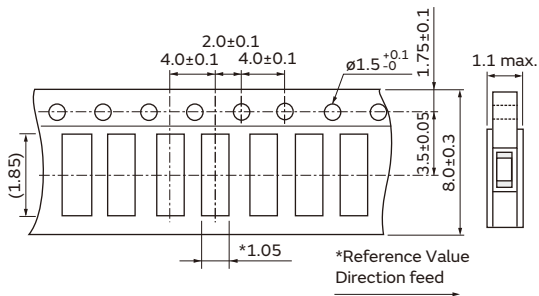

PR□21_RA Series: Embossed Tape

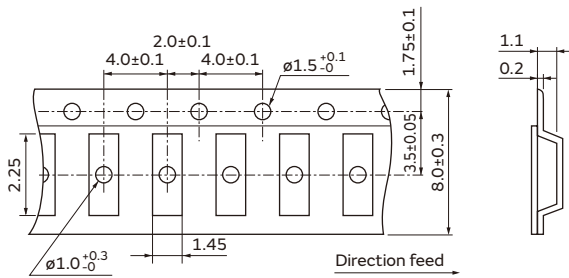

PRG21_RK Series: Embossed Tape

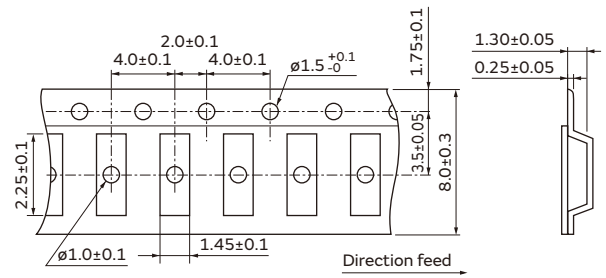

(in mm)

Reel Dimensions

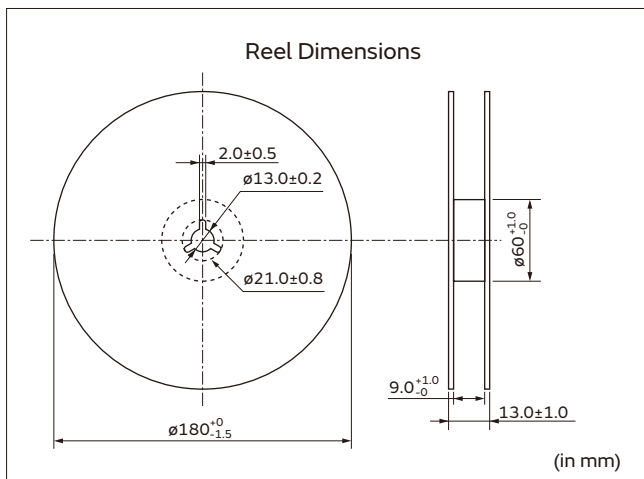

POSISTOR Lead Type Package

Minimum Quantity Guide

Series	Bulk Type		Ammo Pack Taping Type	
	Part Number	Min. Qty. (pcs.)	Part Number	Min. Qty. (pcs.)
16V Series	PTGL5SAR1R0M1B51B0	500	PTGL5SAR1R0M1B51A0	2,000
	PTGL6SAR0R8M1B51B0		PTGL6SAR0R8M1B51A0	
	PTGL7SARR47M1B51B0		PTGL7SARR47M1B51A0	
	PTGL9SARR33M1B51B0		PTGL9SARR33M1B51A0	
	PTGLASARR27M1B51B0	300	PTGLASARR27M1B51A0	-
	PTGLCSAR0R2M1B51B0		PTGLCSAR0R2M1B51A0	
	PTGLESARR15M1B51B0		-	
Narrow Current Band 30V Series	PTGL4SAS100K2B51B0	500	PTGL4SAS100K2B51A0	1,500
	PTGL4SAS100K2N51B0		PTGL4SAS100K2N51A0	
	PTGL5SAS3R9K2B51B0		PTGL5SAS3R9K2B51A0	
	PTGL7SAS1R8K2B51B0		PTGL7SAS1R8K2B51A0	
	PTGL7SAS2R7K2B51B0		PTGL7SAS2R7K2B51A0	
	PTGL9SAS1R2K2B51B0	PTGL9SAS1R2K2B51A0		
	PTGLCSAS0R8K2B51B0	300	PTGLCSAS0R8K2B51A0	-
Narrow Current Band 51V Series	PTGL4SAS100K3B51B0	500	PTGL4SAS100K3B51A0	1,500
	PTGL5SAS6R8K3B51B0		PTGL5SAS6R8K3B51A0	
	PTGL7SAS3R3K3B51B0		PTGL7SAS3R3K3B51A0	
	PTGL9SAS2R2K3B51B0	PTGL9SAS2R2K3B51A0		
	PTGLCSAS1R2K3B51B0	300	PTGLCSAS1R2K3B51A0	-
Narrow Current Band 60V Series	PTGL4SAS220K4B51B0	500	PTGL4SAS220K4B51A0	1,500
	PTGL4SAS220K4N51B0		PTGL4SAS220K4N51A0	
	PTGL5SAS100K4B51B0		PTGL5SAS100K4B51A0	
	PTGL7SAS5R6K4B51B0		PTGL7SAS5R6K4B51A0	
	PTGL7SAS5R6K4N51B0		PTGL7SAS5R6K4N51A0	
	PTGL9SAS3R3K4B51B0	PTGL9SAS3R3K4B51A0		
	PTGLCSAS2R2K4B51B0	300	PTGLCSAS2R2K4B51A0	-
Narrow Current Band 140V Series	PTGL4SAS560K6B51B0	500	PTGL4SAS560K6B51A0	1,500
	PTGL5SAS270K6B51B0		PTGL5SAS270K6B51A0	
	PTGL7SAS150K6B51B0		PTGL7SAS150K6B51A0	
	PTGL9SAS120K6B51B0		PTGL9SAS120K6B51A0	
	PTGL9SAS7R6K6B51B0		PTGL9SAS7R6K6B51A0	
	PTGLCSAS4R7K6B51B0	300	PTGLCSAS4R7K6B51A0	-

Continued on the following page. ↗

POSISTOR Lead Type Package

Continued from the preceding page. ↘

Taping Dimension (PTGL_A0 Series)

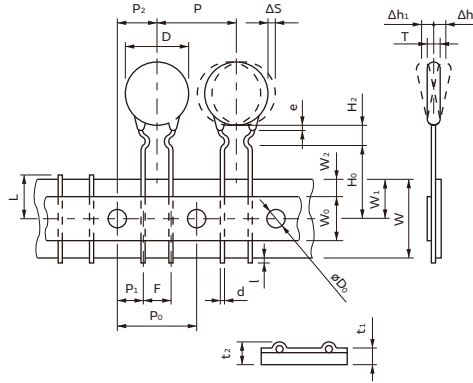

Item	Code	Dimensions (mm)	Note
Pitch of Component	P	12.7	Tolerance is determined by ΔS .
Pitch of Sprocket Hole	P ₀	12.7±0.3	
Lead Spacing	F	5.0 ^{+0.8} _{-0.3}	
Length from Hole Center to Lead	P ₁	3.85±0.8	
Length from Hole Center to Component Center	P ₂	6.35±1.3	Deviation in the feeding direction
Body Diameter	D	Please see in Ratings	
Body Thickness	T	Please see in Ratings	
Deviation along Tape, Left or Right Defect	ΔS	±1.5	Including the inclination caused by lead bending
Carrier Tape Width	W	18.0±0.5	
Position of Sprocket Hole	W ₁	9.0 ^{+0.5} _{-0.75}	Deviation of tape width
Lead Distance between Reference and Bottom Planes	H ₀	16.0±1.0	
	H ₂	6.0 max.	
Protrusion Length	I	+0.5 to -1.0	
Diameter of Sprocket Hole	D ₀	4.0±0.2	
Lead Diameter	d	Please see in Ratings	
Total Tape Thickness	t ₁	0.6±0.3	
Total Thickness of Tape and Lead Wire	t ₂	2.0 max.	
Deviation across Tape	$\Delta h_1, \Delta h_2$	1.5 max.	
Portion to cut in Case of Defect	L	11.0 ⁺⁰ _{-2.0}	
Hold Down Tape Width	W ₀	11.0 min.	
Hold Down Tape Position	W ₂	4.0 max.	
Coating Extension on Lead	e	Up to the center of crimp	

Global Locations

For details please visit www.murata.com



⚠ Note

1 Export Control

For customers outside Japan:

No Murata products should be used or sold, through any channels, for use in the design, development, production, utilization, maintenance or operation of, or otherwise contribution to (1) any weapons (Weapons of Mass Destruction [nuclear, chemical or biological weapons or missiles] or conventional weapons) or (2) goods or systems specially designed or intended for military end-use or utilization by military end-users.

For customers in Japan:

For products which are controlled items subject to the "Foreign Exchange and Foreign Trade Law" of Japan, the export license specified by the law is required for export.

2 Please contact our sales representatives or product engineers before using the products in this catalog for the applications listed below, which require especially high reliability for the prevention of defects which might directly damage a third party's life, body or property, or when one of our products is intended for use in applications other than those specified in this catalog.

- ① Aircraft equipment
- ② Aerospace equipment
- ③ Undersea equipment
- ④ Power plant equipment
- ⑤ Medical equipment
- ⑥ Transportation equipment (vehicles, trains, ships, etc.)
- ⑦ Traffic signal equipment
- ⑧ Disaster prevention / crime prevention equipment
- ⑨ Data-processing equipment
- ⑩ Application of similar complexity and/or reliability requirements to the applications listed above

3 Product specifications in this catalog are as of February 2020. They are subject to change or our products in it may be discontinued without advance notice. Please check with our sales representatives or product engineers before ordering. If there are any questions, please contact our sales representatives or product engineers.

4 Please read rating and ⚠CAUTION (for storage, operating, rating, soldering, mounting and handling) in this catalog to prevent smoking and/or burning, etc.

5 This catalog has only typical specifications. Therefore, please approve our product specifications or transact the approval sheet for product specifications before ordering.

6 Please note that unless otherwise specified, we shall assume no responsibility whatsoever for any conflict or dispute that may occur in connection with the effect of our and/or a third party's intellectual property rights and other related rights in consideration of your use of our products and/or information described or contained in our catalogs. In this connection, no representation shall be made to the effect that any third parties are authorized to use the rights mentioned above under licenses without our consent.

7 No ozone depleting substances (ODS) under the Montreal Protocol are used in our manufacturing process.

Murata Manufacturing Co., Ltd.

www.murata.com

muRata
INNOVATOR IN ELECTRONICS