

Quad 2-Input Exclusive-OR Gate

74AC86

General Description

The 74AC86 contains four, 2-input exclusive-OR gates.

Features

- I_{CC} Reduced by 50%
- Outputs Source/Sink 24 mA
- These Devices are Pb-Free, Halide Free and are RoHS Compliant

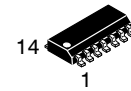

SOIC14
CASE 751EF

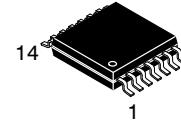

TSSOP-14 WB
CASE 948G

ABSOLUTE MAXIMUM RATINGS

Parameter	Symbol	Value	Unit
Supply Voltage	V _{CC}	-0.5 to +6.5	V
DC Input Diode Current V _I = 0.5 V V _I = V _{CC} + 0.5 V	I _{IK}	-20 +20	mA
DC Input Voltage	V _I	-0.5 to V _{CC} + 0.5	V
DC Output Diode Current V _O = -0.5 V V _O = V _{CC} + 0.5 V	I _{OK}	-20 +20	mA
DC Output Voltage	V _O	-0.5 to V _{CC} + 0.5	V
DC Output Source or Sink Current	I _O	±50	mA
DC V _{CC} or Ground Current per Output Pin	I _{CC} or I _{GND}	±50	mA
Storage Temperature	T _{STG}	-65 to +150	°C
Junction Temperature (PDIP)	T _J	140	°C

Stresses exceeding those listed in the Maximum Ratings table may damage the device. If any of these limits are exceeded, device functionality should not be assumed, damage may occur and reliability may be affected.

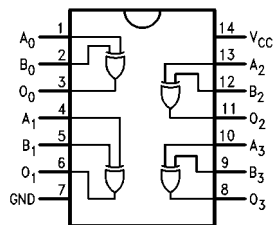

Figure 1. Connection Diagram

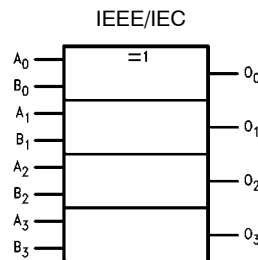
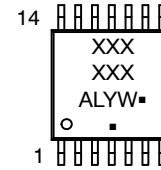
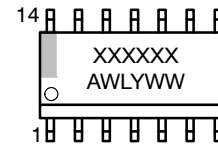

Figure 2. Logic Symbol

MARKING DIAGRAMS



- AC86 = Specific Device Code
- A = Assembly Location
- L, WL = Wafer Lot
- Y = Year
- W, WW = Work Week
- = Pb-Free Package

(Note: Microdot may be in either location)

ORDERING INFORMATION

See detailed ordering and shipping information in the package dimensions section on page 3 of this data sheet.

PIN DESCRIPTION

Pin Names	Description
A ₀ -A ₃	Inputs
B ₀ -B ₃	Inputs
O ₀ -O ₃	Outputs

RECOMMENDED OPERATING CONDITIONS

Symbol	Parameter	Min	Max	Unit
V_{CC}	Supply Voltage	2.0	6.0	V
V_I	Input Voltage	0	V_{CC}	V
V_O	Output Voltage	0	V_{CC}	V
T_A	Operating Temperature	-40	85	°C
$\Delta V/\Delta t$	Minimum Input Edge Rate V_{IN} from 30% to 70% V_{CC} V_{CC} @ 3.3 V, 4.5 V, 5.5 V	125		mV/ns

Functional operation above the stresses listed in the Recommended Operating Ranges is not implied. Extended exposure to stresses beyond the Recommended Operating Ranges limits may affect device reliability.

DC ELECTRICAL CHARACTERISTICS

Symbol	Parameter	V_{CC} (V)	$T_A = +25^\circ\text{C}$		$T_A = -40^\circ\text{C to } +85^\circ\text{C}$		Unit	Conditions
			Typ	Guaranteed Limits				
V_{IH}	Minimum High Level Input Voltage	3.0	1.5	2.1	2.1	V	$V_{OUT} = 0.1\text{ V}$ or $V_{CC} - 0.1\text{ V}$	
		4.5	2.25	3.15	3.15			
		5.5	2.75	3.85	3.85			
V_{IL}	Maximum Low Level Input Voltage	3.0	1.5	0.9	0.9	V	$V_{OUT} = 0.1\text{ V}$ or $V_{CC} - 0.1\text{ V}$	
		4.5	2.25	1.35	1.35			
		5.5	2.75	1.65	1.65			
V_{OH}	Minimum High Level Output Voltage	3.0	2.99	2.9	2.9	V	$I_{OUT} = -50\ \mu\text{A}$	
		4.5	4.49	4.4	4.4			
		5.5	5.49	5.4	5.4			
			3.0	-	2.56	2.46	V	$V_{IN} = V_{IL}$ or V_{IH} $I_{OH} = -12\text{ mA}$ $I_{OH} = -24\text{ mA}$ $I_{OH} = -24\text{ mA}$ (Note 1)
			4.5	-	3.86	3.76		
			5.5	-	4.86	4.76		
V_{OL}	Maximum Low Level Output Voltage	3.0	0.002	0.1	0.1	V	$I_{OUT} = 50\ \mu\text{A}$	
		4.5	0.001	0.1	0.1			
		5.5	0.001	0.1	0.1			
			3.0	-	0.36	0.44	V	$V_{IN} = V_{IL}$ or V_{IH} $I_{OL} = 12\text{ mA}$ $I_{OL} = 24\text{ mA}$ $I_{OL} = 24\text{ mA}$ (Note 1)
			4.5	-	0.36	0.44		
			5.5	-	0.36	0.44		
I_{IN} (Note 3)	Maximum Input Leakage Current	5.5	-	± 0.1	± 1.0	μA	$V_I = V_{CC}, \text{ GND}$	
I_{OLD}	Minimum Dynamic Output Current (Note 2)	5.5	-	-	75	mA	$V_{OLD} = 1.65\text{ V Max}$	
I_{OHD}		5.5	-	-	-75	mA	$V_{OHD} = 3.85\text{ V Min}$	
I_{CC} (Note 3)	Maximum Quiescent Supply Current	5.5	-	2.0	20.0	μA	$V_{IN} = V_{CC}$ or GND	

1. All outputs loaded; thresholds on input associated with output under test.
2. Maximum test duration 2.0 ms, one output loaded at a time.
3. I_{IN} and I_{CC} @ 3.0 V are guaranteed to be less than or equal to the respective limit @ 5.5 V V_{CC} .

74AC86

AC ELECTRICAL CHARACTERISTICS

Symbol	Parameter	V _{CC} * (V)	T _A = +25°C C _L = 50 pF			T _A = -40°C to +85°C C _L = 40 pF		Unit
			Min	Typ	Max	Min	Max	
t _{PHL}	Propagation Delay Inputs to Outputs	3.3	2.0	6.0	11.5	1.5	12.5	ns
		5.0	1.5	4.5	8.5	1.0	9.5	
t _{PLH}	Propagation Delay Inputs to Outputs	3.3	2.0	6.5	11.5	1.5	12.5	ns
		5.0	1.5	4.5	8.5	1.0	9.0	

*Voltage Range 3.3 V is 3.3 V ±0.3 V.
Voltage Range 5.0 V is 5.0 V ±0.5 V.

CAPACITANCE

Symbol	Parameter	Typ	Unit	Conditions
C _{IN}	Input Capacitance	4.5	pF	V _{CC} = OPEN
C _{PD}	Power Dissipation Capacitance	35	pF	V _{CC} = 5.0 V

ORDERING INFORMATION

Device	Marking	Package	Shipping [†]
74AC86MTCX	AC 86	TSSOP-14	2500 Units / Tape & Reel
74AC86SCX	AC86	SOIC-14	2500 Units / Tape & Reel

[†]For information on tape and reel specifications, including part orientation and tape sizes, please refer to our Tape and Reel Packaging Specifications Brochure, BRD8011/D.

MECHANICAL CASE OUTLINE
PACKAGE DIMENSIONS

ON Semiconductor®



SOIC14
CASE 751EF
ISSUE O

DATE 30 SEP 2016

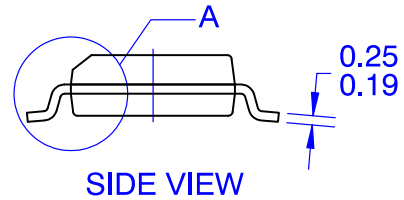
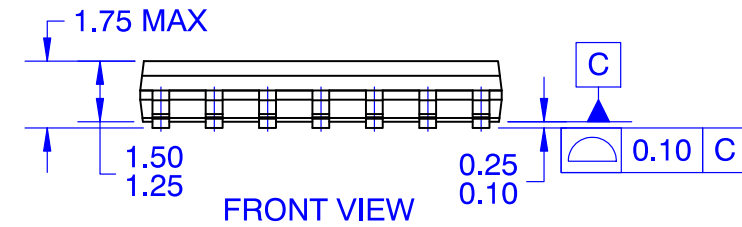
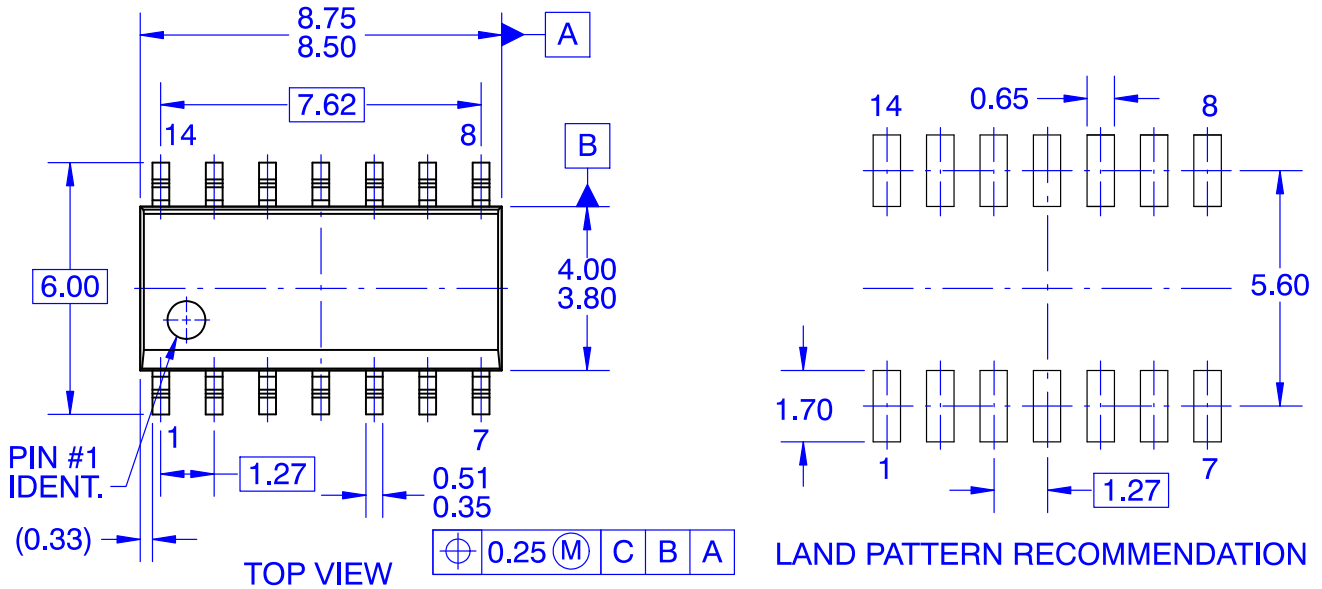

NOTES:

- A. CONFORMS TO JEDEC MS-012, VARIATION AB, ISSUE C
- B. ALL DIMENSIONS ARE IN MILLIMETERS
- C. DIMENSIONS DO NOT INCLUDE MOLD FLASH OR BURRS
- D. LAND PATTERN STANDARD: SOIC127P600X145-14M
- E. CONFORMS TO ASME Y14.5M, 2009

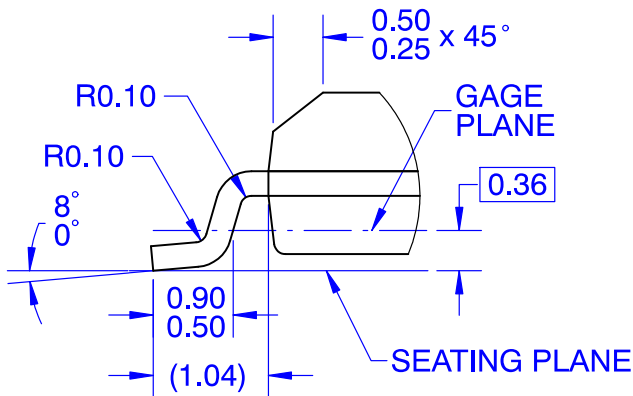

DOCUMENT NUMBER:	98AON13739G	Electronic versions are uncontrolled except when accessed directly from the Document Repository. Printed versions are uncontrolled except when stamped "CONTROLLED COPY" in red.
DESCRIPTION:	SOIC14	PAGE 1 OF 1

ON Semiconductor and are trademarks of Semiconductor Components Industries, LLC dba ON Semiconductor or its subsidiaries in the United States and/or other countries. ON Semiconductor reserves the right to make changes without further notice to any products herein. ON Semiconductor makes no warranty, representation or guarantee regarding the suitability of its products for any particular purpose, nor does ON Semiconductor assume any liability arising out of the application or use of any product or circuit, and specifically disclaims any and all liability, including without limitation special, consequential or incidental damages. ON Semiconductor does not convey any license under its patent rights nor the rights of others.

MECHANICAL CASE OUTLINE PACKAGE DIMENSIONS

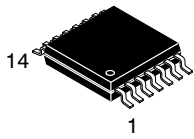

TSSOP-14 WB
CASE 948G
ISSUE C

DATE 17 FEB 2016

SCALE 2:1



NOTES:

- DIMENSIONING AND TOLERANCING PER ANSI Y14.5M, 1982.
- CONTROLLING DIMENSION: MILLIMETER.
- DIMENSION A DOES NOT INCLUDE MOLD FLASH, PROTRUSIONS OR GATE BURRS. MOLD FLASH OR GATE BURRS SHALL NOT EXCEED 0.15 (0.006) PER SIDE.
- DIMENSION B DOES NOT INCLUDE INTERLEAD FLASH OR PROTRUSION. INTERLEAD FLASH OR PROTRUSION SHALL NOT EXCEED 0.25 (0.010) PER SIDE.
- DIMENSION K DOES NOT INCLUDE DAMBAR PROTRUSION. ALLOWABLE DAMBAR PROTRUSION SHALL BE 0.08 (0.003) TOTAL IN EXCESS OF THE K DIMENSION AT MAXIMUM MATERIAL CONDITION.
- TERMINAL NUMBERS ARE SHOWN FOR REFERENCE ONLY.
- DIMENSION A AND B ARE TO BE DETERMINED AT DATUM PLANE -W-.

DIM	MILLIMETERS		INCHES	
	MIN	MAX	MIN	MAX
A	4.90	5.10	0.193	0.200
B	4.30	4.50	0.169	0.177
C	---	1.20	---	0.047
D	0.05	0.15	0.002	0.006
F	0.50	0.75	0.020	0.030
G	0.65 BSC		0.026 BSC	
H	0.50	0.60	0.020	0.024
J	0.09	0.20	0.004	0.008
J1	0.09	0.16	0.004	0.006
K	0.19	0.30	0.007	0.012
K1	0.19	0.25	0.007	0.010
L	6.40 BSC		0.252 BSC	
M	0°	8°	0°	8°

GENERIC MARKING DIAGRAM*



- A = Assembly Location
- L = Wafer Lot
- Y = Year
- W = Work Week
- = Pb-Free Package

(Note: Microdot may be in either location)

*This information is generic. Please refer to device data sheet for actual part marking. Pb-Free indicator, "G" or microdot "▪", may or may not be present. Some products may not follow the Generic Marking.

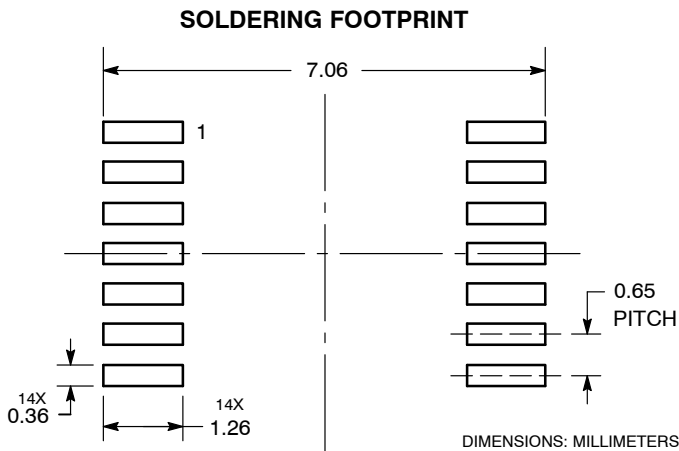

DOCUMENT NUMBER:	98ASH70246A	Electronic versions are uncontrolled except when accessed directly from the Document Repository. Printed versions are uncontrolled except when stamped "CONTROLLED COPY" in red.
DESCRIPTION:	TSSOP-14 WB	PAGE 1 OF 1

onsemi and onsemi are trademarks of Semiconductor Components Industries, LLC dba onsemi or its subsidiaries in the United States and/or other countries. onsemi reserves the right to make changes without further notice to any products herein. onsemi makes no warranty, representation or guarantee regarding the suitability of its products for any particular purpose, nor does onsemi assume any liability arising out of the application or use of any product or circuit, and specifically disclaims any and all liability, including without limitation special, consequential or incidental damages. onsemi does not convey any license under its patent rights nor the rights of others.

onsemi, **Onsemi**, and other names, marks, and brands are registered and/or common law trademarks of Semiconductor Components Industries, LLC dba "**onsemi**" or its affiliates and/or subsidiaries in the United States and/or other countries. **onsemi** owns the rights to a number of patents, trademarks, copyrights, trade secrets, and other intellectual property. A listing of **onsemi**'s product/patent coverage may be accessed at www.onsemi.com/site/pdf/Patent-Marking.pdf. **onsemi** reserves the right to make changes at any time to any products or information herein, without notice. The information herein is provided "as-is" and **onsemi** makes no warranty, representation or guarantee regarding the accuracy of the information, product features, availability, functionality, or suitability of its products for any particular purpose, nor does **onsemi** assume any liability arising out of the application or use of any product or circuit, and specifically disclaims any and all liability, including without limitation special, consequential or incidental damages. Buyer is responsible for its products and applications using **onsemi** products, including compliance with all laws, regulations and safety requirements or standards, regardless of any support or applications information provided by **onsemi**. "Typical" parameters which may be provided in **onsemi** data sheets and/or specifications can and do vary in different applications and actual performance may vary over time. All operating parameters, including "Typicals" must be validated for each customer application by customer's technical experts. **onsemi** does not convey any license under any of its intellectual property rights nor the rights of others. **onsemi** products are not designed, intended, or authorized for use as a critical component in life support systems or any FDA Class 3 medical devices or medical devices with a same or similar classification in a foreign jurisdiction or any devices intended for implantation in the human body. Should Buyer purchase or use **onsemi** products for any such unintended or unauthorized application, Buyer shall indemnify and hold **onsemi** and its officers, employees, subsidiaries, affiliates, and distributors harmless against all claims, costs, damages, and expenses, and reasonable attorney fees arising out of, directly or indirectly, any claim of personal injury or death associated with such unintended or unauthorized use, even if such claim alleges that **onsemi** was negligent regarding the design or manufacture of the part. **onsemi** is an Equal Opportunity/Affirmative Action Employer. This literature is subject to all applicable copyright laws and is not for resale in any manner.

ADDITIONAL INFORMATION

TECHNICAL PUBLICATIONS:

Technical Library: www.onsemi.com/design/resources/technical-documentation
onsemi Website: www.onsemi.com

ONLINE SUPPORT: www.onsemi.com/support

For additional information, please contact your local Sales Representative at www.onsemi.com/support/sales