

THIS DRAWING IS UNPUBLISHED. RELEASED FOR PUBLICATION
 © COPYRIGHT - By - ALL RIGHTS RESERVED.

REVISIONS				
P	LTR	DESCRIPTION	DATE	APVD
R3		26 POS. CONNECTOR PN CORRECTED	04AUG2016	KJK PS

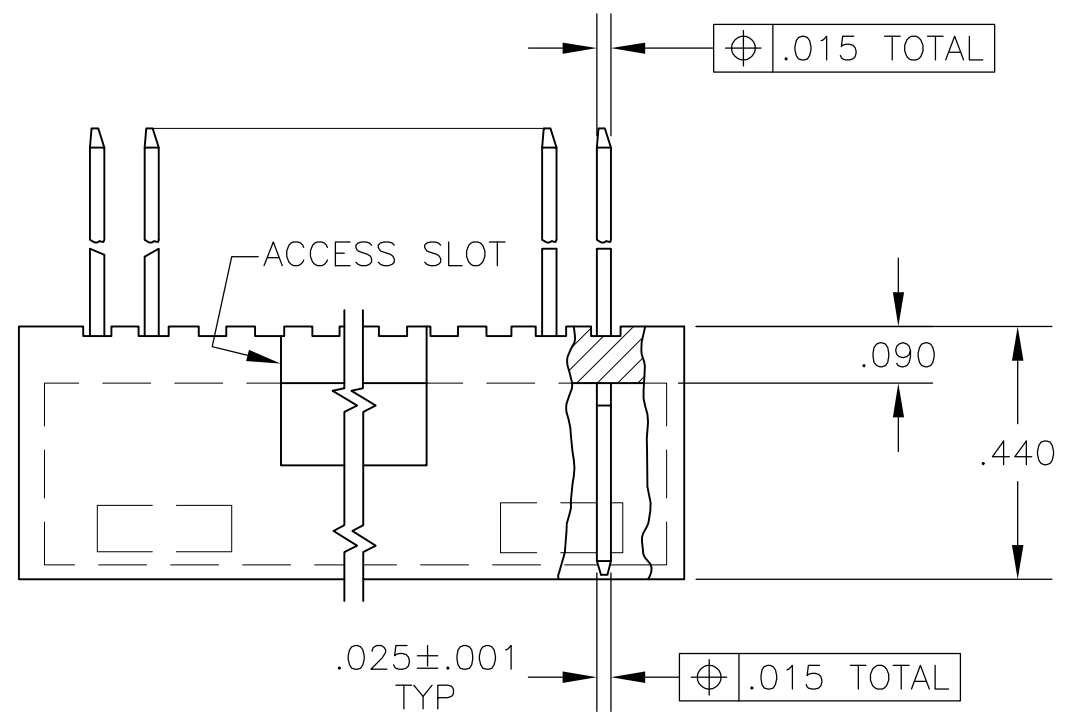

- NOTES
- 1 WILL ALSO MATE W/OTHER CONNECTORS WHICH ARE COMPATIBLE WITH THE $.006$ END DIM.
 - 2 OBSOLETE PART NUMBER.
 - 3 $.000100$ -. $.000200$ BRIGHT TIN-LEAD OVER $.000050$ NICKEL
 - 4 $.000100$ -. $.000200$ BRIGHT TIN OVER $.000050$ -. $.000100$ NICKEL
 - 5 PRELIMINARY PART.
 - 6 $.000100$ -. $.000200$ MATTE TIN OVER $.000050$ -. $.000100$ NICKEL
 - 7 OBSOLETE PARTS: OBSOLETE CIS STREAMLINING PER D.RENAUD/D.SINISI

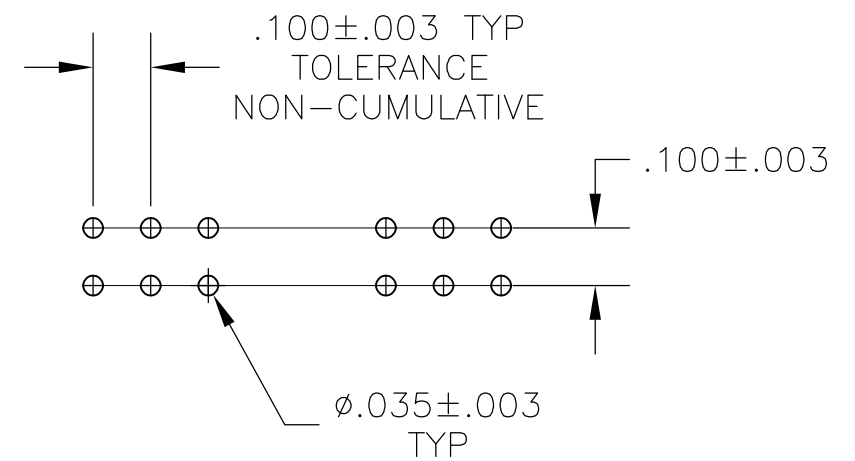
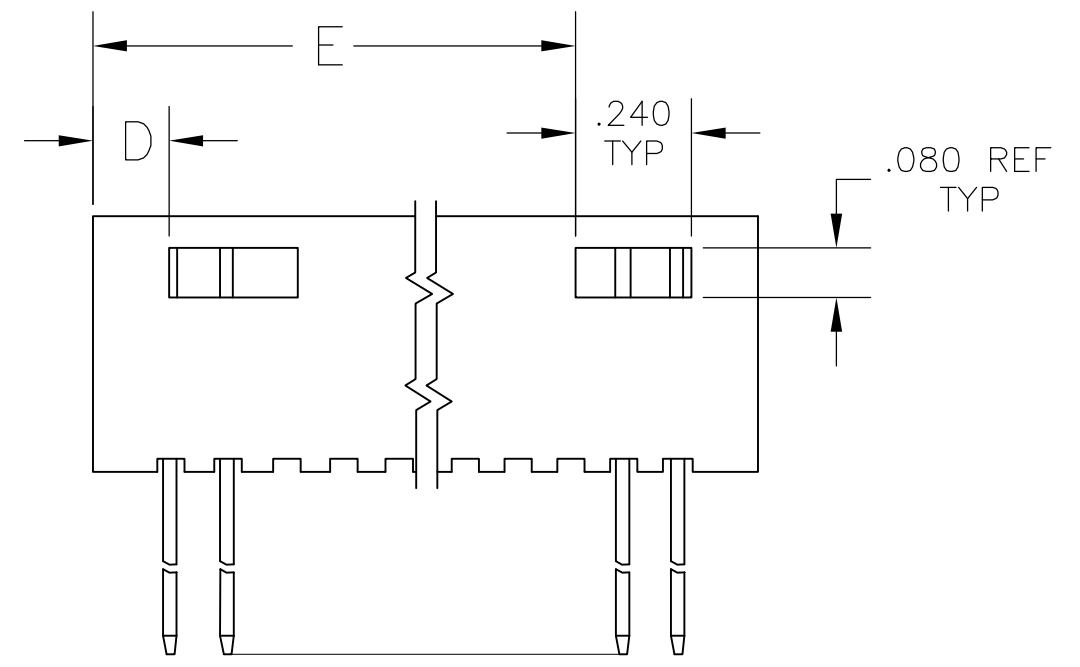
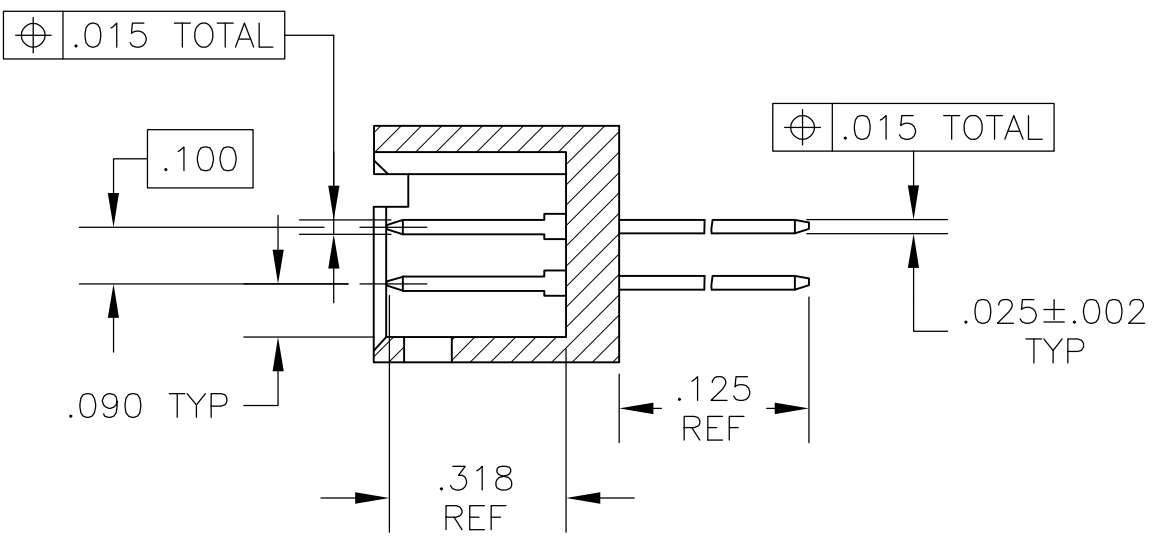
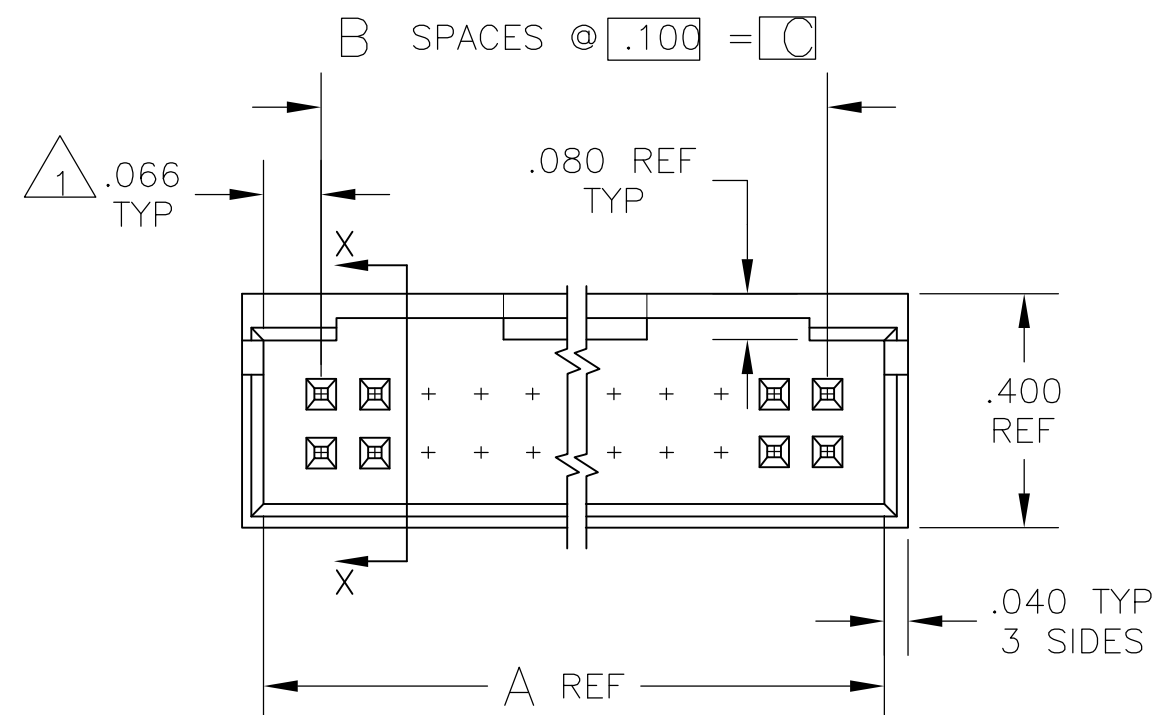

THIS DRAWING IS A CONTROLLED DOCUMENT.		DWN	12 SEP 75		TE Connectivity				
DIMENSIONS: INCHES		CHK	12 SEP 75		NAME				
TOLERANCES UNLESS OTHERWISE SPECIFIED:		APVD	15 SEP 75		HEADER ASSEMBLY MOD II, $.100$ C/L $.025$ SQUARE POST, WITH DETENT				
0 PLC $\pm -$ 1 PLC $\pm -$ 2 PLC $\pm -$ 3 PLC $\pm .005$ 4 PLC $\pm -$ ANGLES $\pm -$		PRODUCT SPEC		SIZE	CAGE CODE	DRAWING NO	RESTRICTED TO		
MATERIAL: HSG: GLASS FILLED NYLON, COLOR: BLACK, CONTACT: PHOS BRONZE		FINISH: SEE TABLE		WEIGHT	A2	00779	C=87589		
CUSTOMER DRAWING				SCALE	3:1	SHEET	1 of 2	REV	R3

THIS DRAWING IS UNPUBLISHED. RELEASED FOR PUBLICATION
 © COPYRIGHT - By - ALL RIGHTS RESERVED.

REVISIONS					
P	LTR	DESCRIPTION	DATE	DWN	APVD
-	-	SEE SHEET 1	-	-	-

FINISH	E	D	C	B	A	NO OF POSN.	PART NO.
-	.106	.200	2	.332	6	8-87589-6	
-	.106	.300	3	.432	8	8-87589-5	
3.506	.106	3.600	36	3.732	74	8-87589-3	
3.406	.106	3.500	35	3.632	72	8-87589-2	
3.306	.106	3.400	34	3.532	70	8-87589-1	
3.206	.106	3.300	33	3.432	68	8-87589-0	
3.106	.106	3.200	32	3.332	66	7-87589-9	
3.006	.106	3.100	31	3.232	64	7-87589-8	
2.906	.106	3.000	30	3.132	62	7-87589-7	
2.806	.106	2.900	29	3.032	60	7-87589-6	
2.706	.106	2.800	28	2.932	58	7-87589-5	
2.606	.106	2.700	27	2.832	56	7-87589-4	
2.506	.106	2.600	26	2.732	54	7-87589-3	
2.406	.106	2.500	25	2.632	52	7-87589-2	
2.306	.106	2.400	24	2.532	50	7-87589-1	
2.206	.106	2.300	23	2.432	48	7-87589-0	
2.106	.106	2.200	22	2.332	46	6-87589-9	
2.006	.106	2.100	21	2.232	44	6-87589-8	
1.906	.106	2.000	20	2.132	42	6-87589-7	
1.806	.106	1.900	19	2.032	40	6-87589-6	
1.706	.106	1.800	18	1.932	38	6-87589-5	
1.606	.106	1.700	17	1.832	36	6-87589-4	
1.506	.106	1.600	16	1.732	34	6-87589-3	
1.406	.106	1.500	15	1.632	32	6-87589-2	
1.306	.106	1.400	14	1.532	30	6-87589-1	
1.206	.106	1.300	13	1.432	28	6-87589-0	
1.106	.106	1.200	12	1.332	26	5-87589-9	
1.006	.106	1.100	11	1.232	24	5-87589-8	
.906	.106	1.000	10	1.132	22	5-87589-7	
.806	.106	.900	9	1.032	20	5-87589-6	
-	.406	.800	8	.932	18	5-87589-5	
-	.306	.700	7	.832	16	5-87589-4	
-	.306	.600	6	.732	14	5-87589-3	
-	.206	.500	5	.632	12	5-87589-2	
-	.206	.400	4	.532	10	5-87589-1	

FINISH	E	D	C	B	A	NO OF POSN.	PART NO.
1.306	.106	1.400	14	1.532	30	3-87589-9	
-	.406	.800	8	.932	18	3-87589-8	
-	.306	.700	7	.832	16	3-87589-7	
-	.106	.200	2	.332	6	3-87589-6	
-	.106	.300	3	.432	8	3-87589-5	
3.506	.106	3.600	36	3.732	74	3-87589-3	
3.406	.106	3.500	35	3.632	72	3-87589-2	
3.306	.106	3.400	34	3.532	70	3-87589-1	
3.206	.106	3.300	33	3.432	68	3-87589-0	
3.106	.106	3.200	32	3.332	66	2-87589-9	
3.006	.106	3.100	31	3.232	64	2-87589-8	
2.906	.106	3.000	30	3.132	62	2-87589-7	
2.806	.106	2.900	29	3.032	60	2-87589-6	
2.706	.106	2.800	28	2.932	58	2-87589-5	
2.606	.106	2.700	27	2.832	56	2-87589-4	
2.506	.106	2.600	26	2.732	54	2-87589-3	
2.406	.106	2.500	25	2.632	52	2-87589-2	
2.306	.106	2.400	24	2.532	50	2-87589-1	
2.206	.106	2.300	23	2.432	48	2-87589-0	
2.106	.106	2.200	22	2.332	46	1-87589-9	
2.006	.106	2.100	21	2.232	44	1-87589-8	
1.906	.106	2.000	20	2.132	42	1-87589-7	
1.806	.106	1.900	19	2.032	40	1-87589-6	
1.706	.106	1.800	18	1.932	38	1-87589-5	
1.606	.106	1.700	17	1.832	36	1-87589-4	
1.506	.106	1.600	16	1.732	34	1-87589-3	
1.406	.106	1.500	15	1.632	32	1-87589-2	
1.306	.106	1.400	14	1.532	30	1-87589-1	
1.206	.106	1.300	13	1.432	28	1-87589-0	
1.106	.106	1.200	12	1.332	26	87589-9	
1.006	.106	1.100	11	1.232	24	87589-8	
.906	.106	1.000	10	1.132	22	87589-7	
.806	.106	.900	9	1.032	20	87589-6	
-	.406	.800	8	.932	18	87589-5	
-	.306	.700	7	.832	16	87589-4	
-	.306	.600	6	.732	14	87589-3	
-	.206	.500	5	.632	12	87589-2	
-	.206	.400	4	.532	10	87589-1	

△7 OBSOLETE
 △7 OBSOLETE
 △7 OBSOLETE
 △7 OBSOLETE
 △7 OBSOLETE
 △7 OBSOLETE

△7 OBSOLETE
 △7 OBSOLETE
 △7 OBSOLETE
 △7 SUPERCEDED BY 6-87589-4
 △7 OBSOLETE
 △7 OBSOLETE
 △7 OBSOLETE

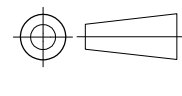
THIS DRAWING IS A CONTROLLED DOCUMENT.		DWN	12 SEP 75	 TE Connectivity
DIMENSIONS: INCHES		CHK	12 SEP 75	
TOLERANCES UNLESS OTHERWISE SPECIFIED:		APVD	15 SEP 75	
 0 PLC ± - 1 PLC ± - 2 PLC ± - 3 PLC ± .005 4 PLC ± - ANGLES ± -		NAME		
MATERIAL: HSG: GLASS FILLED NYLON COLOR: BLACK CONTACT: PHOS BRONZE		WEIGHT		PRODUCT SPEC APPLICATION SPEC SIZE CAGE CODE DRAWING NO A2 00779 C-87589
SEE TABLE		CUSTOMER DRAWING		RESTRICTED TO
		SCALE 1:1 SHEET 2 of 2		REV R3

Mouser Electronics

Authorized Distributor

Click to View Pricing, Inventory, Delivery & Lifecycle Information:

[TE Connectivity:](#)

[87589-2](#)