

TL331B, TL391B and TL331 Single Comparators

1 Features

- NEW [TL331B](#) and [TL391B](#)
- Improved specifications of B-version
 - Maximum rating: up to 38 V
 - ESD rating (HBM): 2k V
 - Improved reverse voltage performance
 - Low input offset: 0.37 mV
 - Low input bias current: 3.5 nA
 - Low supply-current: 430 μ A
 - Faster response time of 1 μ sec
 - [TL391B](#) provides an [alternate pinout](#)
- TL331B is improved drop-in replacement for TL331
- Common-mode input voltage range includes ground
- Differential input voltage range equal to maximum-rated supply voltage: ± 38 V
- Low output saturation voltage
- Output compatible with TTL, MOS, and CMOS

2 Applications

- [Vacuum robot](#)
- [Single phase UPS](#)
- [Server PSU](#)
- [Cordless power tool](#)
- [Wireless infrastructure](#)
- [Appliances](#)
- [Building automation](#)
- [Factory automation & control](#)
- [Motor drives](#)
- [Infotainment & cluster](#)

3 Description

The [TL331B](#) and [TL391B](#) devices are the next generation versions of the industry-standard TL331 comparator. These next generation devices provide outstanding value for cost-sensitive applications, with features including lower offset voltage, higher supply voltage capability, lower supply current, lower input bias current, lower propagation delay, wider temperature range and improved 2kV ESD performance and improved negative input voltage handling with drop-in replacement convenience. The [TL331B](#) is a drop-in improved replacement for both the TL331I and TL331K versions, while the [TL391B](#) provides an [alternate pinout](#) of the TL331B to replace competitive devices.

Operation from dual supplies also is possible as long as the difference between the two supplies is within 2 V to 36 V, and VCC is at least 1.5 V more positive than the input common-mode voltage. Current drain is independent of the supply voltage. The outputs can be connected to other open-collector outputs to achieve wired-AND relationships.

Device Information⁽¹⁾

PART NUMBER	PACKAGE	BODY SIZE (NOM)
TL331, TL331B (Preview), TL391B (Preview)	SOT-23 (5)	2.90 mm x 1.60 mm

(1) For all available packages, see the orderable addendum at the end of the data sheet.

Family Comparison Table

Specification	TL331B , TL391B	TL331I	TL331K	Units
Supply Voltage	3 to 36	2 to 30	2 to 30	V
Total Supply Current (5V to 36V max)	0.43	0.7	0.7	mA
Temperature Range	-40 to 125	-40 to 85	-40 to 105	°C
ESD (HBM)	2000	1000	1000	V
Offset Voltage (Max over temp)	± 4	± 9	± 9	mV
Input Bias Current (typ / max)	3.5 / 25	25 / 250	25 / 250	nA
Response Time (typ)	1	1.3	1.3	μ sec



Table of Contents

1 Features	1	7.1 Overview	9
2 Applications	1	7.2 Functional Block Diagram	9
3 Description	1	7.3 Feature Description	9
4 Revision History	2	7.4 Device Functional Modes	9
5 Pin Configuration and Functions	3	8 Application and Implementation	10
6 Specifications	4	8.1 Application Information	10
6.1 Absolute Maximum Ratings, TL331 and TL331K	4	8.2 Typical Application	10
6.2 Absolute Maximum Ratings, TL331B and TL391B	4	9 Power Supply Recommendations	12
6.3 ESD Ratings, TL331 and TL331K	4	10 Layout	12
6.4 ESD Ratings, TL331B and TL391B	5	10.1 Layout Guidelines	12
6.5 Recommended Operating Conditions, TL331 and TL331K	5	10.2 Layout Example	12
6.6 Recommended Operating Conditions, TL331B and TL391B	5	11 Device and Documentation Support	13
6.7 Thermal Information	5	11.1 Documentation Support	13
6.8 Electrical Characteristics, TL331B and TL391B	6	11.2 Receiving Notification of Documentation Updates	13
6.9 Switching Characteristics, TL331B and TL391B	6	11.3 Community Resources	13
6.10 Electrical Characteristics, TL331 and TL331K	7	11.4 Trademarks	13
6.11 Switching Characteristics, TL331 and TL331K	7	11.5 Electrostatic Discharge Caution	13
6.12 Typical Characteristics, TL331 and TL331K	8	11.6 Glossary	13
7 Detailed Description	9	12 Mechanical, Packaging, and Orderable Information	13

4 Revision History

NOTE: Page numbers for previous revisions may differ from page numbers in the current version.

Changes from Revision G (January 2015) to Revision H	Page
• Added TL331B and TL391B tables and pinouts, Updated front page for new B devices for APL	1
• Added Family Comparison Table to Front Page	1
• Added Input current, I_{IK} in <i>Absolute Maximum Ratings</i>	4
• Changed incorrect TL331 and TL331K Temp Ranges in <i>Recommended Operating Conditions</i>	5
• Changed text from: open-drain output to: open-collector output	9
• Removed sentence: This enables much head room for modern day supplies of 3.3 V and 5.0 V.	9
• Changed the text 'The output NPN will sink current when the positive input voltage is higher than the negative input voltage and the offset voltage' to 'The output NPN will sink current when the negative input voltage is higher than the positive input voltage and the offset voltage.'	9
• Changed Output Current specifications from: to: in <i>Design Parameters</i>	10
• Changed first paragraph of the <i>Response Time</i> section	11
• Added <i>Receiving Notification of Documentation Updates</i> section and <i>Community Resources</i> section	13

5 Pin Configuration and Functions

**TLV331, TLV331B DBV Package
5-Pin SOT-23
Top View**

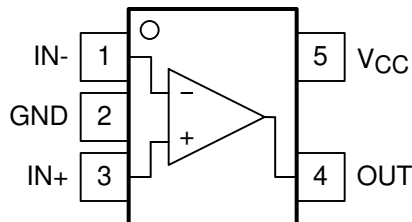

Note reversed inputs compared to similar common pinout

**TLV391B DBV Package
5-Pin SOT-23
Top View**

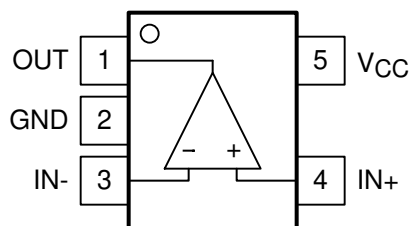

Note reversed inputs compared to similar common pinout

Pin Functions

NAME	PIN		TYPE	DESCRIPTION
	TL331, TL331B NO.	TL391B NO.		
IN+	3	4	I	Positive Input
IN-	1	3	I	Negative Input
OUT	4	1	O	Open Collector/Drain Output
V _{CC}	5	5	—	Power Supply Input
GND	2	2	—	Ground

6 Specifications

6.1 Absolute Maximum Ratings, TL331 and TL331K

 over operating free-air temperature range (unless otherwise noted)⁽¹⁾

		MIN	MAX	UNIT
V _{CC}	Supply voltage ⁽²⁾	0	36	V
V _{ID}	Differential input voltage ⁽³⁾	–36	36	V
V _I	Input voltage range (either input)	–0.3	36	V
V _O	Output voltage	0	36	V
I _O	Output current	0	20	mA
	Duration of output short-circuit to ground ⁽⁴⁾	Unlimited		
I _{IK}	Input current ⁽⁵⁾		–50	mA
T _J	Operating virtual junction temperature	–40	150	°C
T _{stg}	Storage temperature	–65	150	°C

- (1) Stresses beyond those listed under *Absolute Maximum Ratings* may cause permanent damage to the device. These are stress ratings only, which do not imply functional operation of the device at these or any other conditions beyond those indicated under *Recommended Operating Conditions*. Exposure to absolute-maximum-rated conditions for extended periods may affect device reliability.
- (2) All voltage values, except differential voltages, are with respect to the network ground.
- (3) Differential voltages are at IN+ with respect to IN–.
- (4) Short circuits from outputs to V_{CC} can cause excessive heating and eventual destruction.
- (5) Input current flows thorough parasitic diode to ground and will turn on parasitic transistors that will increase ICC and may cause output to be incorrect. Normal operation resumes when input current is removed.

6.2 Absolute Maximum Ratings, TL331B and TL391B

 over operating free-air temperature range (unless otherwise noted)⁽¹⁾

		MIN	MAX	UNIT
V _{CC}	Supply voltage ⁽²⁾	–0.3	38	V
V _{ID}	Differential input voltage ⁽³⁾	–38	38	V
V _I	Input voltage range (either input)	–0.3	38	V
V _O	Output voltage	–0.3	38	V
I _O	Output current		20	mA
	Duration of output short-circuit to ground ⁽⁴⁾	Unlimited		
I _{IK}	Input current ⁽⁵⁾		–50	mA
T _J	Operating virtual junction temperature	–40	150	°C
T _{stg}	Storage temperature	–65	150	°C

- (1) Stresses beyond those listed under *Absolute Maximum Ratings* may cause permanent damage to the device. These are stress ratings only, which do not imply functional operation of the device at these or any other conditions beyond those indicated under *Recommended Operating Conditions*. Exposure to absolute-maximum-rated conditions for extended periods may affect device reliability.
- (2) All voltage values, except differential voltages, are with respect to the network ground.
- (3) Differential voltages are at IN+ with respect to IN–.
- (4) Short circuits from outputs to V_{CC} can cause excessive heating and eventual destruction.
- (5) Input current flows thorough parasitic diode to ground and will turn on parasitic transistors that will increase ICC and may cause output to be incorrect. Normal operation resumes when input current is removed.

6.3 ESD Ratings, TL331 and TL331K

		VALUE	UNIT
V _(ESD)	Electrostatic discharge	Human body model (HBM), per ANSI/ESDA/JEDEC JS-001 ⁽¹⁾	±1000
		Charged device model (CDM), per JEDEC specification JESD22-C101 ⁽²⁾	±750

- (1) JEDEC document JEP155 states that 500-V HBM allows safe manufacturing with a standard ESD control process.
- (2) JEDEC document JEP157 states that 250-V CDM allows safe manufacturing with a standard ESD control process.

6.4 ESD Ratings, TL331B and TL391B

		VALUE	UNIT
V _(ESD)	Electrostatic discharge	Human body model (HBM), per ANSI/ESDA/JEDEC JS-001 ⁽¹⁾	±2000
		Charged device model (CDM), per JEDEC specification JESD22-C101 ⁽²⁾	±750
			V

(1) JEDEC document JEP155 states that 500-V HBM allows safe manufacturing with a standard ESD control process.

(2) JEDEC document JEP157 states that 250-V CDM allows safe manufacturing with a standard ESD control process.

6.5 Recommended Operating Conditions, TL331 and TL331K

over operating free-air temperature range (unless otherwise noted)

		MIN	MAX	UNIT
V _{CC}	Supply voltage	2	36	V
T _J	Junction temperature, TL331	–40	85	°C
T _J	Junction temperature, TL331K	–40	105	°C

6.6 Recommended Operating Conditions, TL331B and TL391B

over operating free-air temperature range (unless otherwise noted)

		MIN	MAX	UNIT
V _{CC}	Supply voltage	3	36	V
T _J	Junction temperature	–40	125	°C

6.7 Thermal Information

THERMAL METRIC ⁽¹⁾		TL331, TL331K	TL331B, TL391B	UNIT
		DBV (SOT-23)	DBV (SOT-23)	
		5 PINS	5 PINS	
R _{θJA}	Junction-to-ambient thermal resistance	218.3	211.7	°C/W
R _{θJC(top)}	Junction-to-case (top) thermal resistance	87.3	133.6	°C/W
R _{θJB}	Junction-to-board thermal resistance	44.9	79.9	°C/W
ψ _{JT}	Junction-to-top characterization parameter	4.3	56.4	°C/W
ψ _{JB}	Junction-to-board characterization parameter	44.1	79.6	°C/W

(1) For more information about traditional and new thermal metrics, see the [Semiconductor and IC Package Thermal Metrics](#) application report.

6.8 Electrical Characteristics, TL331B and TL391B

 $V_S = 5\text{ V}$, $V_{CM} = (V_-)$; $T_A = 25^\circ\text{C}$ (unless otherwise noted).

PARAMETER		TEST CONDITIONS	MIN	TYP	MAX	UNIT
V_{IO}	Input offset voltage	$V_S = 5\text{ to }36\text{V}$	-2.5	± 0.37	2.5	mV
		$V_S = 5\text{ to }36\text{V}$, $T_A = -40^\circ\text{C to }+125^\circ\text{C}$	-4		4	
I_B	Input bias current			-3.5	-25	nA
		$T_A = -40^\circ\text{C to }+125^\circ\text{C}$			-50	nA
I_{OS}	Input offset current		-10	± 0.5	10	nA
		$T_A = -40^\circ\text{C to }+125^\circ\text{C}$	-25		25	nA
V_{CM}	Input voltage range	$V_S = 3\text{ to }36\text{V}$	$(V_-) - 0.1$		$(V_+) - 1.5$	V
		$V_S = 3\text{ to }36\text{V}$, $T_A = -40^\circ\text{C to }+125^\circ\text{C}$	$(V_-) - 0.05$		$(V_+) - 2.0$	V
A_{VD}	Large signal differential voltage amplification	$V_S = 15\text{V}$, $V_O = 1.4\text{V to }11.4\text{V}$; $R_L \geq 15\text{k to } (V_+)$	50	200		V/mV
V_{OL}	Low level output Voltage (swing from (V_-))	$I_{SINK} \leq 4\text{mA}$, $V_{ID} = -1\text{V}$		110	400	mV
		$I_{SINK} \leq 4\text{mA}$, $V_{ID} = -1\text{V}$; $T_A = -40^\circ\text{C to }+125^\circ\text{C}$			550	mV
I_{OH-LKG}	High-level output leakage current	High-level output leakage current $(V_+) = V_O = 5\text{ V}$; $V_{ID} = 1\text{ V}$		0.1	20	nA
I_{OH-LKG}	High-level output leakage current	High-level output leakage current $(V_+) = V_O = 36\text{V}$; $V_{ID} = 1\text{V}$; $T_A = -40^\circ\text{C to }+125^\circ\text{C}$			1000	nA
I_{OL}	Low level output current	$V_{OL} = 1.5\text{V}$; $V_{ID} = -1\text{V}$; $V_S = 5\text{V}$	6	18		mA
I_Q	Quiescent current	$V_S = 5\text{ V}$, no load		210	330	μA
		$V_S = 36\text{ V}$, no load, $T_A = -40^\circ\text{C to }+125^\circ\text{C}$		275	430	μA

6.9 Switching Characteristics, TL331B and TL391B

 $V_S = 5\text{V}$, $V_{O_PULLUP} = 5\text{V}$, $V_{CM} = V_S/2$, $C_L = 15\text{pF}$, $R_L = 5.1\text{k Ohm}$, $T_A = 25^\circ\text{C}$ (unless otherwise noted).

PARAMETER		TEST CONDITIONS	MIN	TYP	MAX	UNIT
t_{response}	Propagation delay time, high-to-low; Small scale input signal ⁽¹⁾	Input overdrive = 5mV, Input step = 100mV		1000		ns
t_{response}	Propagation delay time, high-to-low; TTL input signal ⁽¹⁾	TTL input with $V_{\text{ref}} = 1.4\text{V}$		300		ns

(1) High-to-low and low-to-high refers to the transition at the input.

6.10 Electrical Characteristics, TL331 and TL331K

at specified free-air temperature, $V_{CC} = 5\text{ V}$ (unless otherwise noted)

PARAMETER	TEST CONDITIONS ⁽¹⁾	T_A ⁽²⁾	MIN	TYP	MAX	UNIT
V_{IO} Input offset voltage	$V_{CC} = 5\text{ V to } 30\text{ V}$, $V_O = 1.4\text{ V}$, $V_{IC} = V_{IC(min)}$	25°C		2	5	mV
		Full range			9	
I_{IO} Input offset current	$V_O = 1.4\text{ V}$	25°C		5	50	nA
		Full range			250	
I_{IB} Input bias current	$V_O = 1.4\text{ V}$	25°C		-25	-250	nA
		Full range			-400	
V_{ICR} Common-mode input voltage range ⁽³⁾		Full range		0 to $V_{CC} - 1.5$		V
A_{VD} Large-signal differential voltage amplification	$V_{CC} = 15\text{ V}$, $V_O = 1.4\text{ V to } 11.4\text{ V}$, $R_L \geq 15\text{ k}\Omega$ to V_{CC}	25°C		50	200	V/mV
I_{OH} High-level output current	$V_{OH} = 5\text{ V}$, $V_{ID} = 1\text{ V}$	25°C		0.1	50	nA
	$V_{OH} = 30\text{ V}$, $V_{ID} = 1\text{ V}$	Full range			1	μA
V_{OL} Low-level output voltage	$I_{OL} = 4\text{ mA}$, $V_{ID} = -1\text{ V}$	25°C		150	400	mV
		Full range			700	
I_{OL} Low-level output current	$V_{OL} = 1.5\text{ V}$, $V_{ID} = -1\text{ V}$	25°C		6		mA
I_{CC} Supply current	$R_L = \infty$, $V_{CC} = 5\text{ V}$	25°C		0.4	0.7	mA

(1) All characteristics are measured with zero common-mode input voltage, unless otherwise specified.

(2) Full range T_A is -40°C to $+85^\circ\text{C}$ for I-suffix devices and -40°C to $+105^\circ\text{C}$ for K-suffix devices.

(3) The voltage at either input or common-mode should not be allowed to go negative by more than 0.3 V. The upper end of the common-mode voltage range is $V_{CC+} - 1.5\text{ V}$, but either or both inputs can go to 30 V without damage.

6.11 Switching Characteristics, TL331 and TL331K

 $V_{CC} = 5\text{ V}$, $T_A = 25^\circ\text{C}$

PARAMETER	TEST CONDITIONS	TYP	UNIT	
Response time	R_L connected to 5 V through 5.1 k Ω , $C_L = 15\text{ pF}$ ^{(1) (2)}	100-mV input step with 5-mV overdrive	1.3	μs
		TTL-level input step	0.3	

(1) C_L includes probe and jig capacitance.

(2) The response time specified is the interval between the input step function and the instant when the output crosses 1.4 V.

6.12 Typical Characteristics, TL331 and TL331K

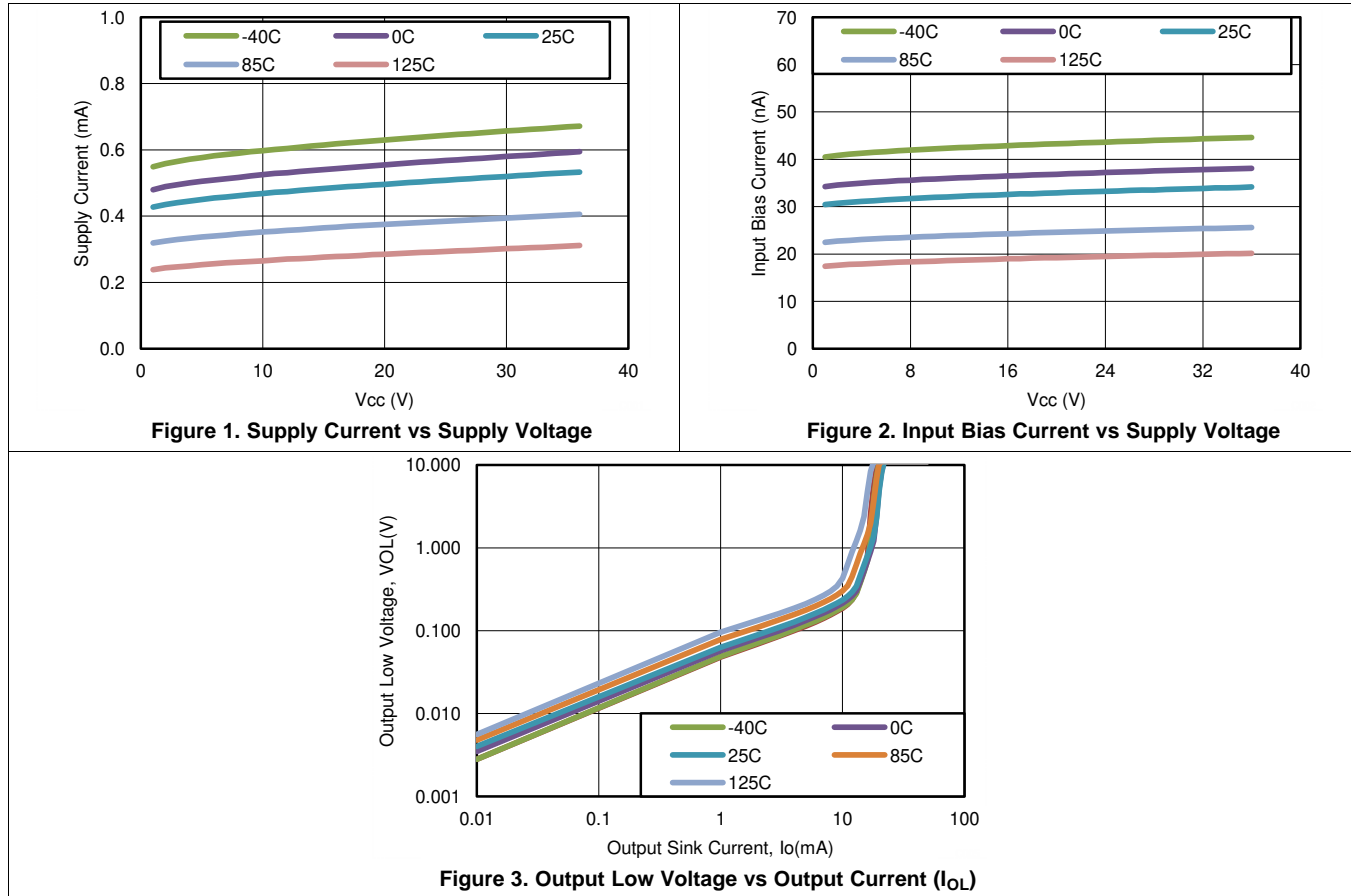

7 Detailed Description

7.1 Overview

The TL331 family is a single comparator with the ability to operate up to 36 V on the supply pin. This standard device has proven ubiquity and versatility across a wide range of applications. This is due to its very wide supply voltages range (2 V to 36 V), low I_q , and fast response.

The open-collector output allows the user to configure the output's logic low voltage (V_{OL}) and can be utilized to enable the comparator to be used in AND functionality.

The TL331B and TL391B are performance upgrades to standard TL331 using the latest process technologies allowing for lower offset voltages, lower input bias and supply currents and faster response time over an extended temperature range. The TL331B can drop-in replace the "I" or "K" versions of TL331. The TL391B is an alternate pinout for replacing competitive devices.

7.2 Functional Block Diagram

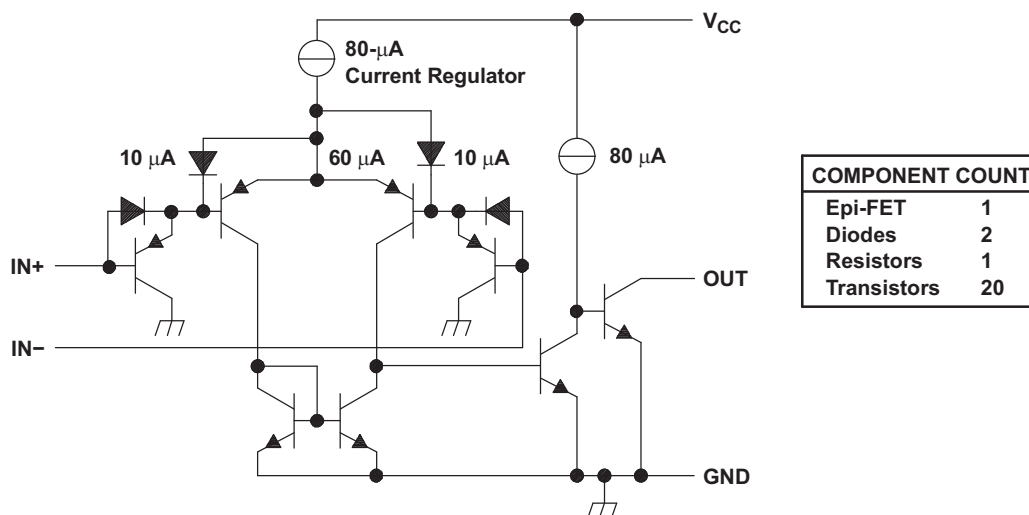

Current values shown are nominal.

7.3 Feature Description

TL331 family consists of a PNP Darlington pair input, allowing the device to operate with very high gain and fast response with minimal input bias current. The input Darlington pair creates a limit on the input common mode voltage capability, allowing TL331 to accurately function from ground to $V_{CC} - 1.5$ V differential input.

The output consists of an open collector NPN (pull-down or low side) transistor. The output NPN will sink current when the negative input voltage is higher than the positive input voltage and the offset voltage. The V_{OL} is resistive and will scale with the output current. Please see [Figure 3](#) for V_{OL} values with respect to the output current.

7.4 Device Functional Modes

7.4.1 Voltage Comparison

The TL331 operates solely as a voltage comparator, comparing the differential voltage between the positive and negative pins and outputting a logic low or high impedance (logic high with pull-up) based on the input differential polarity.

8 Application and Implementation

NOTE

Information in the following applications sections is not part of the TI component specification, and TI does not warrant its accuracy or completeness. TI's customers are responsible for determining suitability of components for their purposes. Customers should validate and test their design implementation to confirm system functionality.

8.1 Application Information

TL331 will typically be used to compare a single signal to a reference or two signals against each other. Many users take advantage of the open drain output to drive the comparison logic output to a logic voltage level to an MCU or logic device. The wide supply range and high voltage capability makes TL331 optimal for level shifting to a higher or lower voltage.

8.2 Typical Application

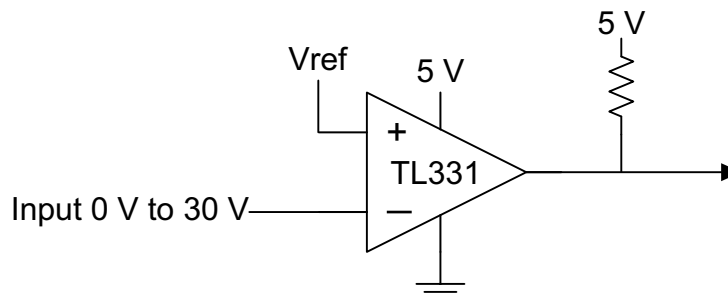

Figure 4. Typical Application Schematic

8.2.1 Design Requirements

For this design example, use the parameters listed in [Table 1](#) as the input parameters.

Table 1. Design Parameters

DESIGN PARAMETER	EXAMPLE VALUE
Input Voltage Range	0 V to $V_{CC} - 1.5$ V
Supply Voltage	2 V to 36 V
Logic Supply Voltage (R_{PULLUP} Voltage)	2 V to 36 V
Output Current (V_{LOGIC}/R_{PULLUP})	1 μ A to 4 mA
Input Overdrive Voltage	100 mV
Reference Voltage	2.5 V
Load Capacitance (C_L)	15 pF

8.2.2 Detailed Design Procedure

When using TL331 in a general comparator application, determine the following:

- Input voltage range
- Minimum overdrive voltage
- Output and drive current
- Response time

8.2.2.1 Input Voltage Range

When choosing the input voltage range, the input common mode voltage range (V_{ICR}) must be taken in to account. If temperature operation is above or below 25°C the V_{ICR} can range from 0 V to $V_{CC} - 1.5$ V. This limits the input voltage range to as high as $V_{CC} - 1.5$ V and as low as 0 V. Operation outside of this range can yield incorrect comparisons.

Below is a list of input voltage situation and their outcomes:

1. When both IN- and IN+ are both within the common mode range:
 - a. If IN- is higher than IN+ and the offset voltage, the output is low and the output transistor is sinking current
 - b. If IN- is lower than IN+ and the offset voltage, the output is high impedance and the output transistor is not conducting
2. When IN- is higher than common mode and IN+ is within common mode, the output is low and the output transistor is sinking current
3. When IN+ is higher than common mode and IN- is within common mode, the output is high impedance and the output transistor is not conducting
4. When IN- and IN+ are both higher than common mode, the output is low and the output transistor is sinking current

8.2.2.2 Minimum Overdrive Voltage

Overdrive Voltage is the differential voltage produced between the positive and negative inputs of the comparator over the offset voltage (V_{IO}). In order to make an accurate comparison the Overdrive Voltage (V_{OD}) should be higher than the input offset voltage (V_{IO}). Overdrive voltage can also determine the response time of the comparator, with the response time decreasing with increasing overdrive. [Figure 5](#) and [Figure 6](#) show positive and negative response times with respect to overdrive voltage.

8.2.2.3 Output and Drive Current

Output current is determined by the load/pull-up resistance and logic/pull-up voltage. The output current will produce a output low voltage (V_{OL}) from the comparator. In which V_{OL} is proportional to the output current. Use [Figure 3](#) to determine V_{OL} based on the output current.

The output current can also effect the transient response. More is explained in the next section.

8.2.2.4 TL331B & TL391B ESD Protection

The "B" versions add dedicated ESD protections on all the pins for improved ESD performance as well as improved negative input voltage handling. Please see Application Note [SNOAA35](#) for more information.

8.2.2.5 Response Time

Response time is a function of input over drive. See [Application Curves](#) for typical response times. The rise and fall times can be determined by the load capacitance (C_L), load/pullup resistance (R_{PULLUP}), and equivalent collector-emitter resistance (R_{CE}).

- The rise time (τ_R) is approximately $\tau_R \sim R_{PULLUP} \times C_L$
- The fall time (τ_F) is approximately $\tau_F \sim R_{CE} \times C_L$
 - R_{CE} can be determined by taking the slope of [Figure 3](#) in its linear region at the desired temperature, or by dividing the V_{OL} by I_{out}

8.2.3 Application Curves

The following curves were generated with 5 V on V_{CC} and V_{Logic} , $R_{PULLUP} = 5.1\text{ k}\Omega$, and 50 pF scope probe.

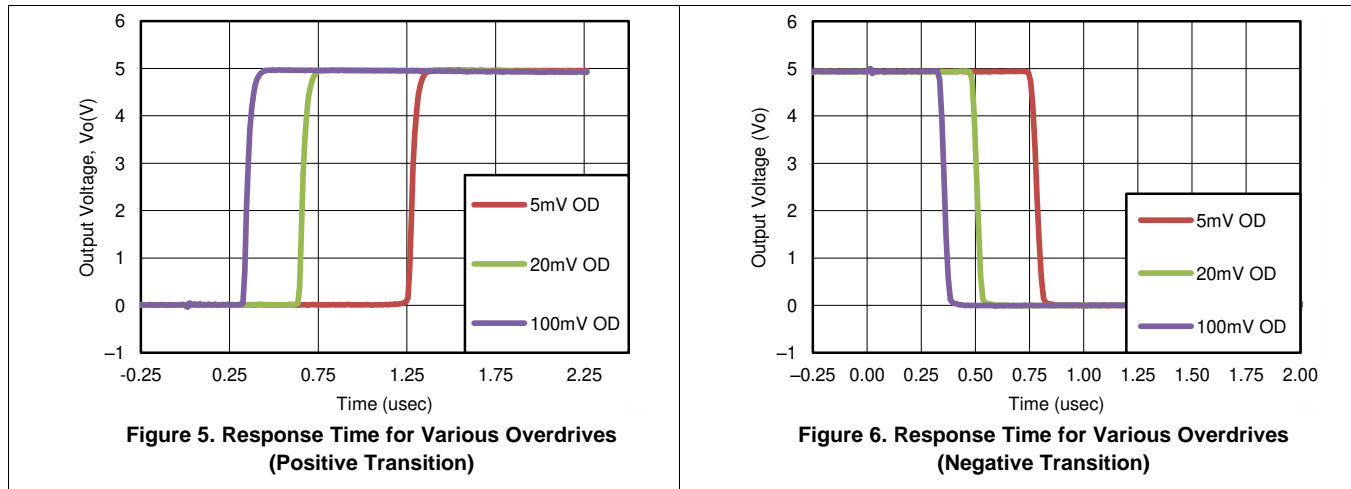

9 Power Supply Recommendations

For fast response and comparison applications with noisy or AC inputs, it is recommended to use a bypass capacitor on the supply pin to reject any variation on the supply voltage. This variation can eat into the comparator's input common mode range and create an inaccurate comparison.

10 Layout

10.1 Layout Guidelines

For accurate comparator applications without hysteresis it is important maintain a stable power supply with minimized noise and glitches, which can affect the high level input common mode voltage range. In order to achieve this, it is best to add a bypass capacitor between the supply voltage and ground. This should be implemented on the positive power supply and negative supply (if available). If a negative supply is not being used, do not put a capacitor between the IC's GND pin and system ground.

10.2 Layout Example

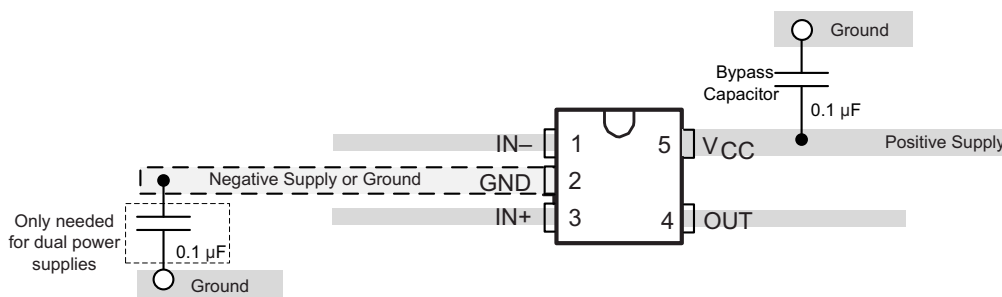

Figure 7. TL331 Layout Example

11 Device and Documentation Support

11.1 Documentation Support

11.1.1 Related Documentation

[Application Design Guidelines for LM339, LM393, TL331 Family Comparators - SNOAA35](#)

[Analog Engineers Circuit Cookbook: Amplifiers \(See Comparators section\) - SLYY137](#)

[Precision Design, Comparator with Hysteresis Reference Design- TIDU020](#)

[Window comparator circuit - SBOA221](#)

[Reference Design, Window Comparator Reference Design- TIPD178](#)

[Comparator with and without hysteresis circuit - SBOA219](#)

[Inverting comparator with hysteresis circuit - SNOA997](#)

[Non-Inverting Comparator With Hysteresis Circuit - SBOA313](#)

[Zero crossing detection using comparator circuit - SNOA999](#)

[PWM generator circuit - SBOA212](#)

[How to Implement Comparators for Improving Performance of Rotary Encoder in Industrial Drive Applications - SNOAA41](#)

[A Quad of Independently Func Comparators - SNOA654](#)

11.2 Receiving Notification of Documentation Updates

To receive notification of documentation updates, navigate to the device product folder on ti.com. In the upper right corner, click on *Alert me* to register and receive a weekly digest of any product information that has changed. For change details, review the revision history included in any revised document.

11.3 Community Resources

[TI E2E™ support forums](#) are an engineer's go-to source for fast, verified answers and design help — straight from the experts. Search existing answers or ask your own question to get the quick design help you need.

Linked content is provided "AS IS" by the respective contributors. They do not constitute TI specifications and do not necessarily reflect TI's views; see TI's [Terms of Use](#).

11.4 Trademarks

E2E is a trademark of Texas Instruments.

All other trademarks are the property of their respective owners.

11.5 Electrostatic Discharge Caution



These devices have limited built-in ESD protection. The leads should be shorted together or the device placed in conductive foam during storage or handling to prevent electrostatic damage to the MOS gates.

11.6 Glossary

[SLYZ022](#) — *TI Glossary*.

This glossary lists and explains terms, acronyms, and definitions.

12 Mechanical, Packaging, and Orderable Information

The following pages include mechanical, packaging, and orderable information. This information is the most current data available for the designated devices. This data is subject to change without notice and revision of this document. For browser-based versions of this data sheet, refer to the left-hand navigation.

PACKAGING INFORMATION

Orderable Device	Status (1)	Package Type	Package Drawing	Pins	Package Qty	Eco Plan (2)	Lead finish/ Ball material (6)	MSL Peak Temp (3)	Op Temp (°C)	Device Marking (4/5)	Samples
PL331BIDBVR	ACTIVE	SOT-23	DBV	5	3000	TBD	Call TI	Call TI	-40 to 125		Samples
PL391BIDBVR	ACTIVE	SOT-23	DBV	5	3000	TBD	Call TI	Call TI	-40 to 125		Samples
TL331BIDBVR	PREVIEW	SOT-23	DBV	5	3000	TBD	Call TI	Call TI	-40 to 125		
TL331IDBVR	ACTIVE	SOT-23	DBV	5	3000	Green (RoHS & no Sb/Br)	NIPDAU	Level-1-260C-UNLIM	-40 to 85	(T1IG, T1IL, T1IS)	Samples
TL331IDBvre4	ACTIVE	SOT-23	DBV	5	3000	Green (RoHS & no Sb/Br)	NIPDAU	Level-1-260C-UNLIM	-40 to 85	T1IG	Samples
TL331IDBVRG4	ACTIVE	SOT-23	DBV	5	3000	Green (RoHS & no Sb/Br)	NIPDAU	Level-1-260C-UNLIM	-40 to 85	T1IG	Samples
TL331IDBVT	ACTIVE	SOT-23	DBV	5	250	Green (RoHS & no Sb/Br)	NIPDAU	Level-1-260C-UNLIM	-40 to 85	(T1IG, T1IL, T1IU)	Samples
TL331IDBVTG4	ACTIVE	SOT-23	DBV	5	250	Green (RoHS & no Sb/Br)	NIPDAU	Level-1-260C-UNLIM	-40 to 85	T1IG	Samples
TL331KDBVR	ACTIVE	SOT-23	DBV	5	3000	Green (RoHS & no Sb/Br)	NIPDAU SN	Level-1-260C-UNLIM	-40 to 105	(T1KG, T1KJ, T1KL)	Samples
TL331KDBVRG4	ACTIVE	SOT-23	DBV	5	3000	Green (RoHS & no Sb/Br)	SN	Level-1-260C-UNLIM	-40 to 105	(T1KG, T1KJ, T1KL)	Samples
TL331KDBVT	ACTIVE	SOT-23	DBV	5	250	Green (RoHS & no Sb/Br)	SN	Level-1-260C-UNLIM	-40 to 105	(T1KG, T1KJ, T1KL)	Samples
TL391BIDBVR	PREVIEW	SOT-23	DBV	5	3000	TBD	Call TI	Call TI	-40 to 125		

(1) The marketing status values are defined as follows:

ACTIVE: Product device recommended for new designs.

LIFEBUY: TI has announced that the device will be discontinued, and a lifetime-buy period is in effect.

NRND: Not recommended for new designs. Device is in production to support existing customers, but TI does not recommend using this part in a new design.

PREVIEW: Device has been announced but is not in production. Samples may or may not be available.

OBSELETE: TI has discontinued the production of the device.

(2) **RoHS:** TI defines "RoHS" to mean semiconductor products that are compliant with the current EU RoHS requirements for all 10 RoHS substances, including the requirement that RoHS substance do not exceed 0.1% by weight in homogeneous materials. Where designed to be soldered at high temperatures, "RoHS" products are suitable for use in specified lead-free processes. TI may reference these types of products as "Pb-Free".

RoHS Exempt: TI defines "RoHS Exempt" to mean products that contain lead but are compliant with EU RoHS pursuant to a specific EU RoHS exemption.

Green: TI defines "Green" to mean the content of Chlorine (Cl) and Bromine (Br) based flame retardants meet JS709B low halogen requirements of <=1000ppm threshold. Antimony trioxide based flame retardants must also meet the <=1000ppm threshold requirement.

(3) MSL, Peak Temp. - The Moisture Sensitivity Level rating according to the JEDEC industry standard classifications, and peak solder temperature.

(4) There may be additional marking, which relates to the logo, the lot trace code information, or the environmental category on the device.

(5) Multiple Device Markings will be inside parentheses. Only one Device Marking contained in parentheses and separated by a "~" will appear on a device. If a line is indented then it is a continuation of the previous line and the two combined represent the entire Device Marking for that device.

(6) Lead finish/Ball material - Orderable Devices may have multiple material finish options. Finish options are separated by a vertical ruled line. Lead finish/Ball material values may wrap to two lines if the finish value exceeds the maximum column width.

Important Information and Disclaimer:The information provided on this page represents TI's knowledge and belief as of the date that it is provided. TI bases its knowledge and belief on information provided by third parties, and makes no representation or warranty as to the accuracy of such information. Efforts are underway to better integrate information from third parties. TI has taken and continues to take reasonable steps to provide representative and accurate information but may not have conducted destructive testing or chemical analysis on incoming materials and chemicals. TI and TI suppliers consider certain information to be proprietary, and thus CAS numbers and other limited information may not be available for release.

In no event shall TI's liability arising out of such information exceed the total purchase price of the TI part(s) at issue in this document sold by TI to Customer on an annual basis.

OTHER QUALIFIED VERSIONS OF TL331 :

● Automotive: [TL331-Q1](#)

● Enhanced Product: [TL331-EP](#)

NOTE: Qualified Version Definitions:

- Automotive - Q100 devices qualified for high-reliability automotive applications targeting zero defects
- Enhanced Product - Supports Defense, Aerospace and Medical Applications

TAPE AND REEL INFORMATION

QUADRANT ASSIGNMENTS FOR PIN 1 ORIENTATION IN TAPE

*All dimensions are nominal

Device	Package Type	Package Drawing	Pins	SPQ	Reel Diameter (mm)	Reel Width W1 (mm)	A0 (mm)	B0 (mm)	K0 (mm)	P1 (mm)	W (mm)	Pin1 Quadrant
TL331IDBVR	SOT-23	DBV	5	3000	178.0	9.0	3.23	3.17	1.37	4.0	8.0	Q3
TL331IDBVR	SOT-23	DBV	5	3000	180.0	8.4	3.23	3.17	1.37	4.0	8.0	Q3
TL331IDBVRG4	SOT-23	DBV	5	3000	178.0	9.0	3.23	3.17	1.37	4.0	8.0	Q3
TL331IDBVT	SOT-23	DBV	5	250	178.0	9.0	3.3	3.2	1.4	4.0	8.0	Q3
TL331IDBVTG4	SOT-23	DBV	5	250	178.0	9.0	3.3	3.2	1.4	4.0	8.0	Q3
TL331KDBVR	SOT-23	DBV	5	3000	178.0	9.0	3.23	3.17	1.37	4.0	8.0	Q3
TL331KDBVR	SOT-23	DBV	5	3000	178.0	9.0	3.3	3.2	1.4	4.0	8.0	Q3
TL331KDBVT	SOT-23	DBV	5	250	178.0	9.0	3.3	3.2	1.4	4.0	8.0	Q3
TL331KDBVT	SOT-23	DBV	5	250	178.0	9.0	3.23	3.17	1.37	4.0	8.0	Q3

TAPE AND REEL BOX DIMENSIONS

*All dimensions are nominal

Device	Package Type	Package Drawing	Pins	SPQ	Length (mm)	Width (mm)	Height (mm)
TL331IDBVR	SOT-23	DBV	5	3000	180.0	180.0	18.0
TL331IDBVR	SOT-23	DBV	5	3000	202.0	201.0	28.0
TL331IDBVRG4	SOT-23	DBV	5	3000	180.0	180.0	18.0
TL331IDBVT	SOT-23	DBV	5	250	180.0	180.0	18.0
TL331IDBVTG4	SOT-23	DBV	5	250	180.0	180.0	18.0
TL331KDBVR	SOT-23	DBV	5	3000	180.0	180.0	18.0
TL331KDBVR	SOT-23	DBV	5	3000	180.0	180.0	18.0
TL331KDBVT	SOT-23	DBV	5	250	180.0	180.0	18.0
TL331KDBVT	SOT-23	DBV	5	250	180.0	180.0	18.0

EXAMPLE BOARD LAYOUT

DBV0005A

SOT-23 - 1.45 mm max height

SMALL OUTLINE TRANSISTOR



LAND PATTERN EXAMPLE
EXPOSED METAL SHOWN
SCALE:15X

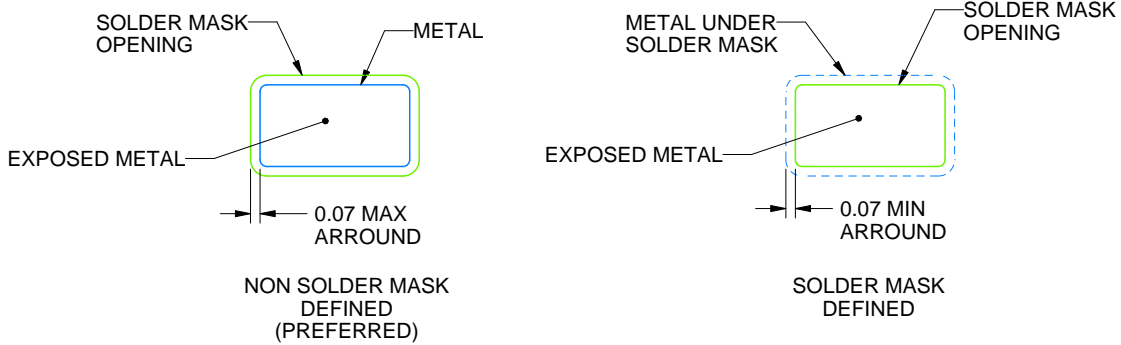

SOLDER MASK DETAILS

4214839/E 09/2019

NOTES: (continued)

- 5. Publication IPC-7351 may have alternate designs.
- 6. Solder mask tolerances between and around signal pads can vary based on board fabrication site.

EXAMPLE STENCIL DESIGN

DBV0005A

SOT-23 - 1.45 mm max height

SMALL OUTLINE TRANSISTOR



SOLDER PASTE EXAMPLE
BASED ON 0.125 mm THICK STENCIL
SCALE:15X

4214839/E 09/2019

NOTES: (continued)

7. Laser cutting apertures with trapezoidal walls and rounded corners may offer better paste release. IPC-7525 may have alternate design recommendations.
8. Board assembly site may have different recommendations for stencil design.

IMPORTANT NOTICE AND DISCLAIMER

TI PROVIDES TECHNICAL AND RELIABILITY DATA (INCLUDING DATASHEETS), DESIGN RESOURCES (INCLUDING REFERENCE DESIGNS), APPLICATION OR OTHER DESIGN ADVICE, WEB TOOLS, SAFETY INFORMATION, AND OTHER RESOURCES "AS IS" AND WITH ALL FAULTS, AND DISCLAIMS ALL WARRANTIES, EXPRESS AND IMPLIED, INCLUDING WITHOUT LIMITATION ANY IMPLIED WARRANTIES OF MERCHANTABILITY, FITNESS FOR A PARTICULAR PURPOSE OR NON-INFRINGEMENT OF THIRD PARTY INTELLECTUAL PROPERTY RIGHTS.

These resources are intended for skilled developers designing with TI products. You are solely responsible for (1) selecting the appropriate TI products for your application, (2) designing, validating and testing your application, and (3) ensuring your application meets applicable standards, and any other safety, security, or other requirements. These resources are subject to change without notice. TI grants you permission to use these resources only for development of an application that uses the TI products described in the resource. Other reproduction and display of these resources is prohibited. No license is granted to any other TI intellectual property right or to any third party intellectual property right. TI disclaims responsibility for, and you will fully indemnify TI and its representatives against, any claims, damages, costs, losses, and liabilities arising out of your use of these resources.

TI's products are provided subject to TI's Terms of Sale (www.ti.com/legal/termsofsale.html) or other applicable terms available either on ti.com or provided in conjunction with such TI products. TI's provision of these resources does not expand or otherwise alter TI's applicable warranties or warranty disclaimers for TI products.

Mailing Address: Texas Instruments, Post Office Box 655303, Dallas, Texas 75265
Copyright © 2020, Texas Instruments Incorporated