

## 250 mA, 16V, Low Quiescent Current LDO Regulator

### Features:

- 2.0  $\mu$ A Typical Quiescent Current
- Input Operating Voltage Range: 2.7V to 16.0V
- 250 mA Output Current for Output Voltages  $\geq$  2.5V
- 200 mA Output Current for Output Voltages  $<$  2.5V
- Low Dropout Voltage, 625 mV typical @ 250 mA for  $V_R = 2.8V$
- 0.4% Typical Output Voltage Tolerance
- Standard Output Voltage Options:
  - 1.2V, 1.5V, 1.8V, 2.5V, 2.8V, 3.0V, 3.3V, 4.0V, 5.0V
- Output Voltage Range: 1.2V to 5.5V in 0.1V Increments (50 mV increments available upon request)
- Stable with 1.0  $\mu$ F to 22  $\mu$ F Ceramic Output Capacitance
- Short-Circuit Protection
- Overtemperature Protection

### Applications:

- Battery-Powered Devices
- Battery-Powered Alarm Circuits
- Smoke Detectors
- CO<sup>2</sup> Detectors
- Pagers and Cellular Phones
- Smart Battery Packs
- Low Quiescent Current Voltage Reference
- PDAs
- Digital Cameras
- Microcontroller Power
- Solar-Powered Instruments
- Consumer Products
- Battery-Powered Data Loggers

### Related Literature:

- AN765, "Using Microchip's Micropower LDOs", DS00765, Microchip Technology Inc., 2002
- AN766, "Pin-Compatible CMOS Upgrades to Bipolar LDOs", DS00766, Microchip Technology Inc., 2002
- AN792, "A Method to Determine How Much Power a SOT23 Can Dissipate in an Application", DS00792, Microchip Technology Inc., 2001

### Description:

The MCP1703 is a family of CMOS low dropout (LDO) voltage regulators that can deliver up to 250 mA of current while consuming only 2.0  $\mu$ A of quiescent current (typical). The input operating range is specified from 2.7V to 16.0V, making it an ideal choice for two to six primary cell battery-powered applications, 9V alkaline and one or two cell Li-Ion-powered applications.

The MCP1703 is capable of delivering 250 mA with only 625 mV (typical) of input to output voltage differential ( $V_{OUT} = 2.8V$ ). The output voltage tolerance of the MCP1703 is typically  $\pm 0.4%$  at  $+25^\circ\text{C}$  and  $\pm 3%$  maximum over the operating junction temperature range of  $-40^\circ\text{C}$  to  $+125^\circ\text{C}$ . Line regulation is  $\pm 0.1%$  typical at  $+25^\circ\text{C}$ .

Output voltages available for the MCP1703 range from 1.2V to 5.5V. The LDO output is stable when using only 1  $\mu$ F of output capacitance. Ceramic, tantalum, or aluminum electrolytic capacitors can all be used for input and output. Overcurrent limit and overtemperature shutdown provide a robust solution for any application. Package options include the SOT-223-3, SOT-23A, 2x3 DFN-8, and SOT-89-3.

### Package Types



# MCP1703

## Functional Block Diagrams

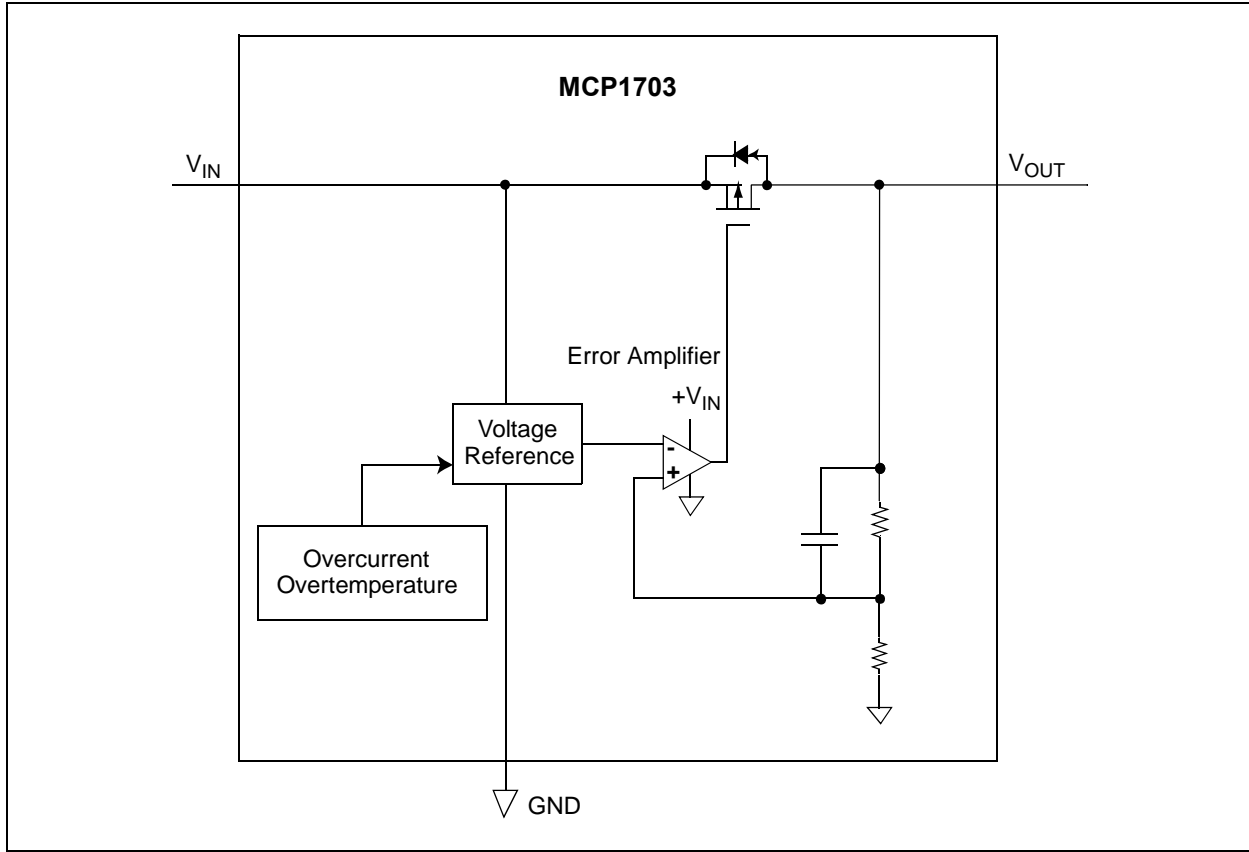

## Typical Application Circuits



## 1.0 ELECTRICAL CHARACTERISTICS

### Absolute Maximum Ratings †

V <sub>DD</sub> .....	+18V
All inputs and outputs w.r.t. ....	(V <sub>SS</sub> -0.3V) to (V <sub>IN</sub> +0.3V)
Peak Output Current .....	500 mA
Storage temperature .....	-65°C to +150°C
Maximum Junction Temperature.....	+150°C
ESD protection on all pins (HBM;MM).....	≥ 4 kV; ≥ 400V

† **Notice:** Stresses above those listed under “Maximum Ratings” may cause permanent damage to the device. This is a stress rating only and functional operation of the device at those or any other conditions above those indicated in the operational listings of this specification is not implied. Exposure to maximum rating conditions for extended periods may affect device reliability.

### DC CHARACTERISTICS

**Electrical Specifications:** Unless otherwise specified, all limits are established for V<sub>IN</sub> = V<sub>OUT(MAX)</sub> + V<sub>DROPOUT(MAX)</sub>, **Note 1**, I<sub>LOAD</sub> = 100 μA, C<sub>OUT</sub> = 1 μF (X7R), C<sub>IN</sub> = 1 μF (X7R), T<sub>A</sub> = +25°C.  
**Boldface** type applies for junction temperatures, T<sub>J</sub> (**Note 7**) of -40°C to +125°C.

Parameters	Symbol	Min	Typ	Max	Units	Conditions
<b>Input / Output Characteristics</b>						
Input Operating Voltage	V <sub>IN</sub>	<b>2.7</b>	—	<b>16.0</b>	V	<b>Note 1</b>
Input Quiescent Current	I <sub>q</sub>	—	2.0	<b>5</b>	μA	I <sub>L</sub> = 0 mA
Maximum Output Current	I <sub>OUT_mA</sub>	<b>250</b>	—	—	mA	For V <sub>R</sub> ≥ 2.5V
		<b>50</b>	100	—	mA	For V <sub>R</sub> < 2.5V, V <sub>IN</sub> ≥ 2.7V
		<b>100</b>	130	—	mA	For V <sub>R</sub> < 2.5V, V <sub>IN</sub> ≥ 2.95V
		<b>150</b>	200	—	mA	For V <sub>R</sub> < 2.5V, V <sub>IN</sub> ≥ 3.2V
		<b>200</b>	250	—	mA	For V <sub>R</sub> < 2.5V, V <sub>IN</sub> ≥ 3.45V
Output Short Circuit Current	I <sub>OUT_SC</sub>	—	400	—	mA	V <sub>IN</sub> = V <sub>IN(MIN)</sub> ( <b>Note 1</b> ), V <sub>OUT</sub> = GND, Current (average current) measured 10 ms after short is applied.
Output Voltage Regulation	V <sub>OUT</sub>	<b>V<sub>R</sub>-3.0%</b>	V <sub>R</sub> ±0.4%	<b>V<sub>R</sub>+3.0%</b>	V	<b>Note 2</b>
		V <sub>R</sub> -2.0%	V <sub>R</sub> ±0.4%	V <sub>R</sub> +2.0%	V	
		V <sub>R</sub> -1.0%	V <sub>R</sub> ±0.4%	V <sub>R</sub> +1.0%	V	1% Custom
V <sub>OUT</sub> Temperature Coefficient	TCV <sub>OUT</sub>	—	50	—	ppm/°C	<b>Note 3</b>
Line Regulation	$\frac{\Delta V_{OUT}}{V_{OUT} \times \Delta V_{IN}}$	<b>-0.3</b>	±0.1	<b>+0.3</b>	%/V	(V <sub>OUT(MAX)</sub> + V <sub>DROPOUT(MAX)</sub> ) ≤ V <sub>IN</sub> ≤ 16V, <b>Note 1</b>
Load Regulation	$\Delta V_{OUT}/V_{OUT}$	<b>-2.5</b>	±1.0	<b>+2.5</b>	%	I <sub>L</sub> = 1.0 mA to 250 mA for V <sub>R</sub> ≥ 2.5V I <sub>L</sub> = 1.0 mA to 200 mA for V <sub>R</sub> < 2.5V V <sub>IN</sub> = 3.65V, <b>Note 4</b>

- Note 1:** The minimum V<sub>IN</sub> must meet two conditions: V<sub>IN</sub> ≥ 2.7V and V<sub>IN</sub> ≥ (V<sub>OUT(MAX)</sub> + V<sub>DROPOUT(MAX)</sub>).
- 2:** V<sub>R</sub> is the nominal regulator output voltage. For example: V<sub>R</sub> = 1.2V, 1.5V, 1.8V, 2.5V, 2.8V, 3.0V, 3.3V, 4.0V, or 5.0V. The input voltage V<sub>IN</sub> = V<sub>OUT(MAX)</sub> + V<sub>DROPOUT(MAX)</sub> or V<sub>IN</sub> = 2.7V (whichever is greater); I<sub>OUT</sub> = 100 μA.
- 3:** TCV<sub>OUT</sub> = (V<sub>OUT-HIGH</sub> - V<sub>OUT-LOW</sub>) \* 10<sup>6</sup> / (V<sub>R</sub> \* ΔTemperature), V<sub>OUT-HIGH</sub> = highest voltage measured over the temperature range. V<sub>OUT-LOW</sub> = lowest voltage measured over the temperature range.
- 4:** Load regulation is measured at a constant junction temperature using low duty cycle pulse testing. Changes in output voltage due to heating effects are determined using thermal regulation specification TCV<sub>OUT</sub>.
- 5:** Dropout voltage is defined as the input to output differential at which the output voltage drops 2% below its measured value with an applied input voltage of V<sub>OUT(MAX)</sub> + V<sub>DROPOUT(MAX)</sub> or 2.7V, whichever is greater.
- 6:** The maximum allowable power dissipation is a function of ambient temperature, the maximum allowable junction temperature and the thermal resistance from junction to air (i.e., T<sub>A</sub>, T<sub>J</sub>, θ<sub>JA</sub>). Exceeding the maximum allowable power dissipation will cause the device operating junction temperature to exceed the maximum 150°C rating. Sustained junction temperatures above 150°C can impact the device reliability.
- 7:** The junction temperature is approximated by soaking the device under test at an ambient temperature equal to the desired junction temperature. The test time is small enough such that the rise in the junction temperature over the ambient temperature is not significant.

# MCP1703

## DC CHARACTERISTICS (CONTINUED)

**Electrical Specifications:** Unless otherwise specified, all limits are established for  $V_{IN} = V_{OUT(MAX)} + V_{DROPOUT(MAX)}$ , **Note 1**,  $I_{LOAD} = 100 \mu A$ ,  $C_{OUT} = 1 \mu F$  (X7R),  $C_{IN} = 1 \mu F$  (X7R),  $T_A = +25^\circ C$ .  
**Boldface** type applies for junction temperatures,  $T_J$  (**Note 7**) of  $-40^\circ C$  to  $+125^\circ C$ .

Parameters	Symbol	Min	Typ	Max	Units	Conditions
Dropout Voltage <b>Note 1, Note 5</b>	$V_{DROPOUT}$	—	330	<b>650</b>	mV	$I_L = 250 \text{ mA}$ , $V_R = 5.0V$
		—	525	<b>725</b>	mV	$I_L = 250 \text{ mA}$ , $3.3V \leq V_R < 5.0V$
		—	625	<b>975</b>	mV	$I_L = 250 \text{ mA}$ , $2.8V \leq V_R < 3.3V$
		—	750	<b>1100</b>	mV	$I_L = 250 \text{ mA}$ , $2.5V \leq V_R < 2.8V$
		—	—	—	mV	$V_R < 2.5V$ , See Maximum Output Current Parameter
Output Delay Time	$T_{DELAY}$	—	1000	—	$\mu s$	$V_{IN} = 0V$ to $6V$ , $V_{OUT} = 90\% V_R$ , $R_L = 50\Omega$ resistive
Output Noise	$e_N$	—	8	—	$\mu V/(Hz)^{1/2}$	$I_L = 50 \text{ mA}$ , $f = 1 \text{ kHz}$ , $C_{OUT} = 1 \mu F$
Power Supply Ripple Rejection Ratio	PSRR	—	44	—	dB	$f = 100 \text{ Hz}$ , $C_{OUT} = 1 \mu F$ , $I_L = 100 \mu A$ , $V_{INAC} = 100 \text{ mV pk-pk}$ , $C_{IN} = 0 \mu F$ , $V_R = 1.2V$
Thermal Shutdown Protection	$T_{SD}$	—	150	—	$^\circ C$	

- Note 1:** The minimum  $V_{IN}$  must meet two conditions:  $V_{IN} \geq 2.7V$  and  $V_{IN} \geq (V_{OUT(MAX)} + V_{DROPOUT(MAX)})$ .
- 2:**  $V_R$  is the nominal regulator output voltage. For example:  $V_R = 1.2V, 1.5V, 1.8V, 2.5V, 2.8V, 3.0V, 3.3V, 4.0V$ , or  $5.0V$ . The input voltage  $V_{IN} = V_{OUT(MAX)} + V_{DROPOUT(MAX)}$  or  $V_{IN} = 2.7V$  (whichever is greater);  $I_{OUT} = 100 \mu A$ .
- 3:**  $TCV_{OUT} = (V_{OUT-HIGH} - V_{OUT-LOW}) * 10^6 / (V_R * \Delta \text{Temperature})$ ,  $V_{OUT-HIGH}$  = highest voltage measured over the temperature range.  $V_{OUT-LOW}$  = lowest voltage measured over the temperature range.
- 4:** Load regulation is measured at a constant junction temperature using low duty cycle pulse testing. Changes in output voltage due to heating effects are determined using thermal regulation specification  $TCV_{OUT}$ .
- 5:** Dropout voltage is defined as the input to output differential at which the output voltage drops 2% below its measured value with an applied input voltage of  $V_{OUT(MAX)} + V_{DROPOUT(MAX)}$  or  $2.7V$ , whichever is greater.
- 6:** The maximum allowable power dissipation is a function of ambient temperature, the maximum allowable junction temperature and the thermal resistance from junction to air (i.e.,  $T_A$ ,  $T_J$ ,  $\theta_{JA}$ ). Exceeding the maximum allowable power dissipation will cause the device operating junction temperature to exceed the maximum  $150^\circ C$  rating. Sustained junction temperatures above  $150^\circ C$  can impact the device reliability.
- 7:** The junction temperature is approximated by soaking the device under test at an ambient temperature equal to the desired junction temperature. The test time is small enough such that the rise in the junction temperature over the ambient temperature is not significant.

## TEMPERATURE SPECIFICATIONS<sup>(1)</sup>

Parameters	Sym	Min	Typ	Max	Units	Conditions
<b>Temperature Ranges</b>						
Operating Junction Temperature Range	$T_J$	-40	—	+125	$^\circ C$	Steady State
Maximum Junction Temperature	$T_J$	—	—	+150	$^\circ C$	Transient
Storage Temperature Range	$T_A$	-65	—	+150	$^\circ C$	
<b>Thermal Package Resistance (Note 2)</b>						
Thermal Resistance, 3LD SOT-223	$\theta_{JA}$	—	62	—	$^\circ C/W$	EIA/JEDEC JESD51-7
	$\theta_{JC}$	—	15	—		FR-4 0.063 4-Layer Board
Thermal Resistance, 3LD SOT-23A	$\theta_{JA}$	—	336	—	$^\circ C/W$	EIA/JEDEC JESD51-7
	$\theta_{JC}$	—	110	—		FR-4 0.063 4-Layer Board
Thermal Resistance, 3LD SOT-89	$\theta_{JA}$	—	153,3	—	$^\circ C/W$	EIA/JEDEC JESD51-7
	$\theta_{JC}$	—	100	—		FR-4 0.063 4-Layer Board
Thermal Resistance, 8LD 2x3 DFN	$\theta_{JA}$	—	93	—	$^\circ C/W$	EIA/JEDEC JESD51-7
	$\theta_{JC}$	—	26	—		FR-4 0.063 4-Layer Board

- Note 1:** The maximum allowable power dissipation is a function of ambient temperature, the maximum allowable junction temperature and the thermal resistance from junction to air (i.e.,  $T_A$ ,  $T_J$ ,  $\theta_{JA}$ ). Exceeding the maximum allowable power dissipation will cause the device operating junction temperature to exceed the maximum  $150^\circ C$  rating. Sustained junction temperatures above  $150^\circ C$  can impact the device reliability.
- 2:** Thermal Resistance values are subject to change. Please visit the Microchip web site for the latest packaging information.

## 2.0 TYPICAL PERFORMANCE CURVES

**Note:** The graphs and tables provided following this note are a statistical summary based on a limited number of samples and are provided for informational purposes only. The performance characteristics listed herein are not tested or guaranteed. In some graphs or tables, the data presented may be outside the specified operating range (e.g., outside specified power supply range) and therefore outside the warranted range.

**Note:** Unless otherwise indicated:  $V_R = 1.8V$ ,  $C_{OUT} = 1 \mu F$  Ceramic (X7R),  $C_{IN} = 1 \mu F$  Ceramic (X7R),  $I_L = 100 \mu A$ ,  $T_A = +25^\circ C$ ,  $V_{IN} = V_{OUT(MAX)} + V_{DROPOUT(MAX)}$  or  $2.7V$ , whichever is greater.

**Note:** Junction Temperature ( $T_J$ ) is approximated by soaking the device under test to an ambient temperature equal to the desired junction temperature. The test time is small enough such that the rise in Junction temperature over the Ambient temperature is not significant.

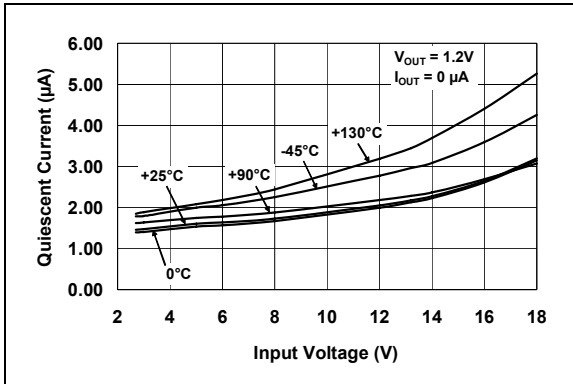

**FIGURE 2-1:** Quiescent Current vs. Input Voltage.

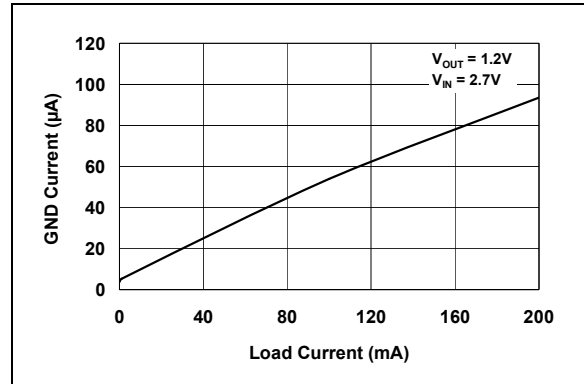

**FIGURE 2-4:** Ground Current vs. Load Current.



**FIGURE 2-2:** Quiescent Current vs. Input Voltage.

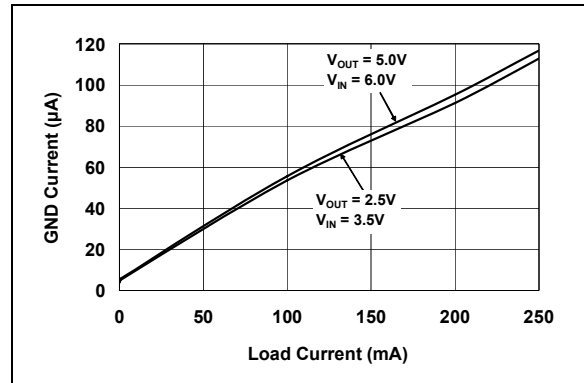

**FIGURE 2-5:** Ground Current vs. Load Current.



**FIGURE 2-3:** Quiescent Current vs. Input Voltage.

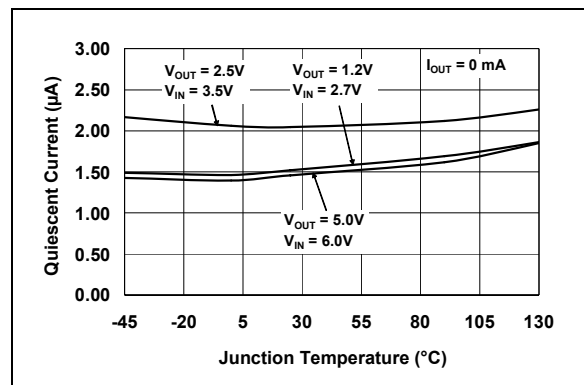

**FIGURE 2-6:** Quiescent Current vs. Junction Temperature.

# MCP1703

**Note:** Unless otherwise indicated:  $V_R = 1.8V$ ,  $C_{OUT} = 1 \mu F$  Ceramic (X7R),  $C_{IN} = 1 \mu F$  Ceramic (X7R),  $I_L = 100 \mu A$ ,  $T_A = +25^\circ C$ ,  $V_{IN} = V_{OUT(MAX)} + V_{DROPOUT(MAX)}$  or  $2.7V$ , whichever is greater.



**FIGURE 2-7:** Output Voltage vs. Input Voltage.



**FIGURE 2-10:** Output Voltage vs. Load Current.



**FIGURE 2-8:** Output Voltage vs. Input Voltage.



**FIGURE 2-11:** Output Voltage vs. Load Current.



**FIGURE 2-9:** Output Voltage vs. Input Voltage.



**FIGURE 2-12:** Output Voltage vs. Load Current.

**Note:** Unless otherwise indicated:  $V_R = 1.8V$ ,  $C_{OUT} = 1 \mu F$  Ceramic (X7R),  $C_{IN} = 1 \mu F$  Ceramic (X7R),  $I_L = 100 \mu A$ ,  $T_A = +25^\circ C$ ,  $V_{IN} = V_{OUT(MAX)} + V_{DROPOUT(MAX)}$  or  $2.7V$ , whichever is greater.



**FIGURE 2-13:** Dropout Voltage vs. Load Current.



**FIGURE 2-16:** Dynamic Line Response.

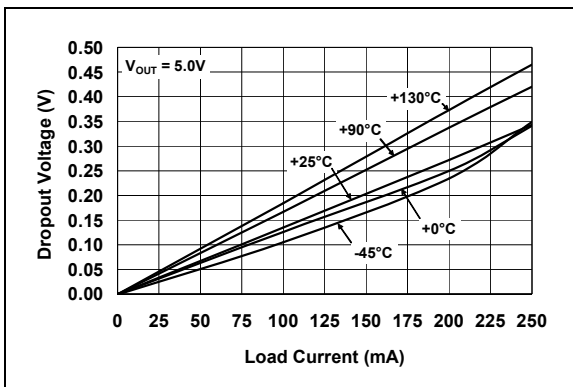

**FIGURE 2-14:** Dropout Voltage vs. Load Current.

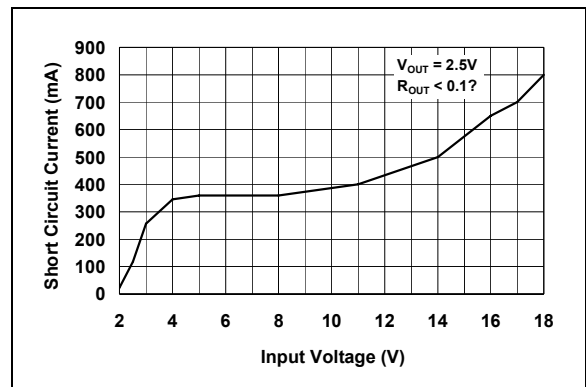

**FIGURE 2-17:** Short Circuit Current vs. Input Voltage.

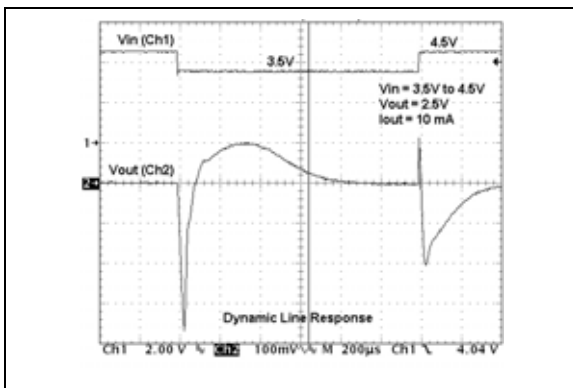

**FIGURE 2-15:** Dynamic Line Response.

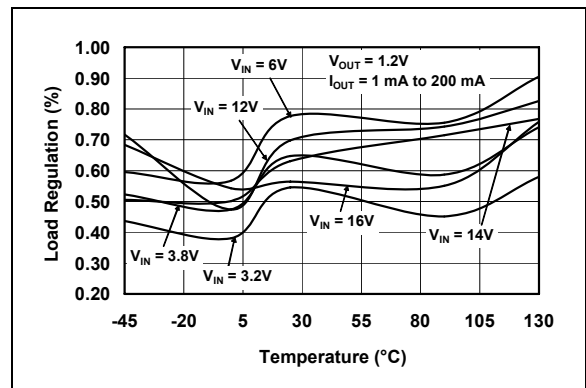

**FIGURE 2-18:** Load Regulation vs. Temperature.

# MCP1703

**Note:** Unless otherwise indicated:  $V_R = 1.8V$ ,  $C_{OUT} = 1 \mu F$  Ceramic (X7R),  $C_{IN} = 1 \mu F$  Ceramic (X7R),  $I_L = 100 \mu A$ ,  $T_A = +25^\circ C$ ,  $V_{IN} = V_{OUT(MAX)} + V_{DROPOUT(MAX)}$  or  $2.7V$ , whichever is greater.

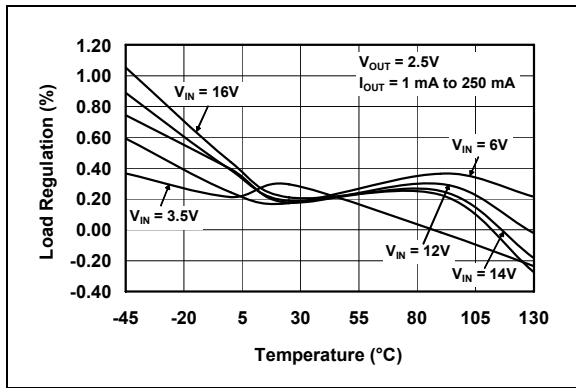

**FIGURE 2-19:** Load Regulation vs. Temperature.

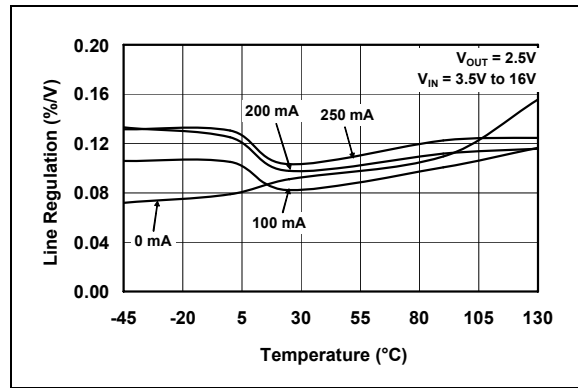

**FIGURE 2-22:** Line Regulation vs. Temperature.

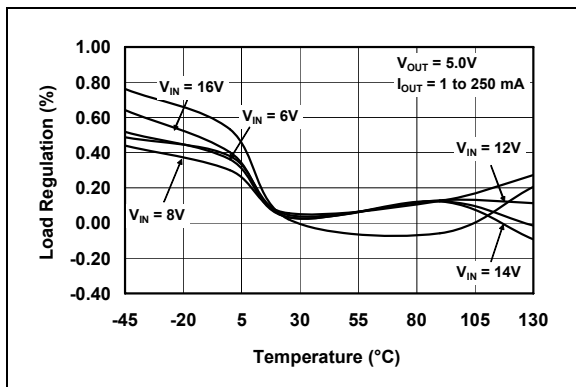

**FIGURE 2-20:** Load Regulation vs. Temperature.

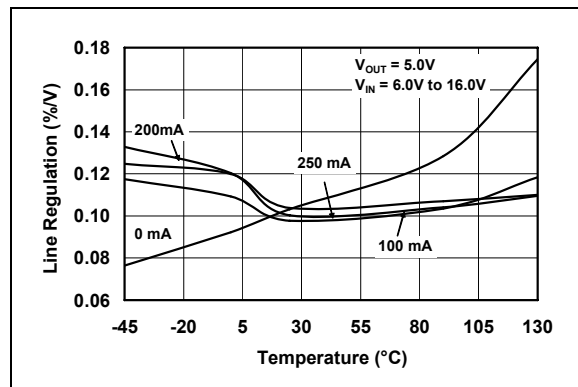

**FIGURE 2-23:** Line Regulation vs. Temperature.

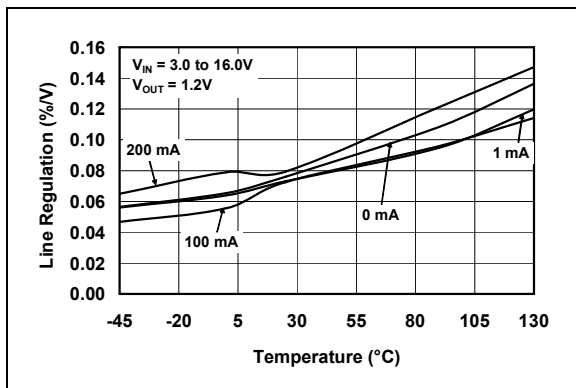

**FIGURE 2-21:** Line Regulation vs. Temperature.



**FIGURE 2-24:** PSRR vs. Frequency.



**Note:** Unless otherwise indicated:  $V_R = 1.8V$ ,  $C_{OUT} = 1 \mu F$  Ceramic (X7R),  $C_{IN} = 1 \mu F$  Ceramic (X7R),  $I_L = 100 \mu A$ ,  $T_A = +25^\circ C$ ,  $V_{IN} = V_{OUT(MAX)} + V_{DROPOUT(MAX)}$  or  $2.7V$ , whichever is greater.



**FIGURE 2-25:** PSRR vs. Frequency.



**FIGURE 2-28:** Dynamic Load Response.



**FIGURE 2-26:** Output Noise vs. Frequency.



**FIGURE 2-29:** Dynamic Load Response.

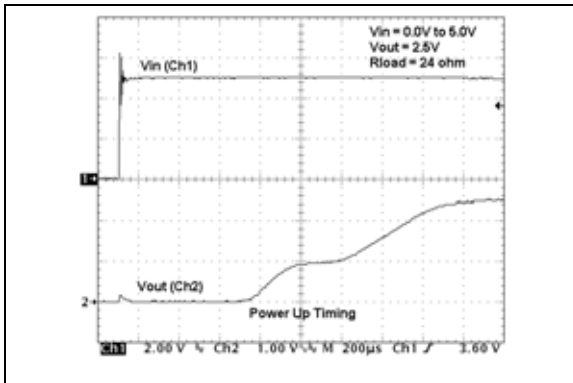

**FIGURE 2-27:** Power Up Timing.



**FIGURE 2-30:** Output Voltage vs. Input Voltage.

# MCP1703

---



**FIGURE 2-31:** Output Voltage vs. Input Voltage.

### 3.0 PIN DESCRIPTIONS

The descriptions of the pins are listed in [Table 3-1](#).

**TABLE 3-1: MCP1703 PIN FUNCTION TABLE**

Pin No. 2x3 DFN-8	Pin No. SOT-223-3	Pin No. SOT-23A	Pin No. SOT-89-3	Name	Function
4	2,Tab	1	1	GND	Ground Terminal
1	3	2	3	V <sub>OUT</sub>	Regulated Voltage Output
8	1	3	2,Tab	V <sub>IN</sub>	Unregulated Supply Voltage
2, 3, 5, 6, 7	—	—	—	NC	No Connection
9	—	—	—	EP	Exposed Thermal Pad (EP); must be connected to VSS

#### 3.1 Ground Terminal (GND)

Regulator ground. Tie GND to the negative side of the output and the negative side of the input capacitor. Only the LDO bias current (2.0  $\mu$ A typical) flows out of this pin; there is no high current. The LDO output regulation is referenced to this pin. Minimize voltage drops between this pin and the negative side of the load.

#### 3.2 Regulated Output Voltage (V<sub>OUT</sub>)

Connect V<sub>OUT</sub> to the positive side of the load and the positive terminal of the output capacitor. The positive side of the output capacitor should be physically located as close to the LDO V<sub>OUT</sub> pin as is practical. The current flowing out of this pin is equal to the DC load current.

#### 3.3 Unregulated Input Voltage (V<sub>IN</sub>)

Connect V<sub>IN</sub> to the input unregulated source voltage. Like all low dropout linear regulators, low source impedance is necessary for the stable operation of the LDO. The amount of capacitance required to ensure low source impedance will depend on the proximity of the input source capacitors or battery type. For most applications, 1  $\mu$ F of capacitance will ensure stable operation of the LDO circuit. For applications that have load currents below 100 mA, the input capacitance requirement can be lowered. The type of capacitor used can be ceramic, tantalum, or aluminum electrolytic. The low ESR characteristics of the ceramic will yield better noise and PSRR performance at high-frequency.

#### 3.4 Exposed Thermal Pad (EP)

There is an internal electrical connection between the Exposed Thermal Pad (EP) and the V<sub>SS</sub> pin; they must be connected to the same potential on the Printed Circuit Board (PCB).

# MCP1703

## 4.0 DETAILED DESCRIPTION

### 4.1 Output Regulation

A portion of the LDO output voltage is fed back to the internal error amplifier and compared with the precision internal band gap reference. The error amplifier output will adjust the amount of current that flows through the P-Channel pass transistor, thus regulating the output voltage to the desired value. Any changes in input voltage or output current will cause the error amplifier to respond and adjust the output voltage to the target voltage (refer to [Figure 4-1](#)).

### 4.2 Overcurrent

The MCP1703 internal circuitry monitors the amount of current flowing through the P-Channel pass transistor. In the event of a short-circuit or excessive output current, the MCP1703 will turn off the P-Channel device for a short period, after which the LDO will attempt to restart. If the excessive current remains, the cycle will repeat itself.

### 4.3 Overtemperature

The internal power dissipation within the LDO is a function of input-to-output voltage differential and load current. If the power dissipation within the LDO is excessive, the internal junction temperature will rise above the typical shutdown threshold of 150°C. At that point, the LDO will shut down and begin to cool to the typical turn-on junction temperature of 130°C. If the power dissipation is low enough, the device will continue to cool and operate normally. If the power dissipation remains high, the thermal shutdown protection circuitry will again turn off the LDO, protecting it from catastrophic failure.



**FIGURE 4-1:** Block Diagram.

## 5.0 FUNCTIONAL DESCRIPTION

The MCP1703 CMOS low dropout linear regulator is intended for applications that need the lowest current consumption while maintaining output voltage regulation. The operating continuous load range of the MCP1703 is from 0 mA to 250 mA ( $V_R \geq 2.5V$ ). The input operating voltage range is from 2.7V to 16.0V, making it capable of operating from two or more alkaline cells or single and multiple Li-Ion cell batteries.

### 5.1 Input

The input of the MCP1703 is connected to the source of the P-Channel PMOS pass transistor. As with all LDO circuits, a relatively low source impedance ( $10\Omega$ ) is needed to prevent the input impedance from causing the LDO to become unstable. The size and type of the capacitor needed depends heavily on the input source type (battery, power supply) and the output current range of the application. For most applications (up to 100 mA), a 1  $\mu F$  ceramic capacitor will be sufficient to ensure circuit stability. Larger values can be used to improve circuit AC performance.

### 5.2 Output

The maximum rated continuous output current for the MCP1703 is 250 mA ( $V_R \geq 2.5V$ ). For applications where  $V_R < 2.5V$ , the maximum output current is 200 mA.

A minimum output capacitance of 1.0  $\mu F$  is required for small signal stability in applications that have up to 250 mA output current capability. The capacitor type can be ceramic, tantalum, or aluminum electrolytic. The Equivalent Series Resistance (ESR) range on the output capacitor can range from  $0\Omega$  to  $2.0\Omega$ .

The output capacitor range for ceramic capacitors is 1  $\mu F$  to 22  $\mu F$ . Higher output capacitance values may be used for tantalum and electrolytic capacitors. Higher output capacitor values pull the pole of the LDO transfer function inward that results in higher phase shifts which in turn cause a lower crossover frequency. The circuit designer should verify the stability by applying line step and load step testing to their system when using capacitance values greater than 22  $\mu F$ .

### 5.3 Output Rise Time

When powering up the internal reference output, the typical output rise time of 1000  $\mu s$  is controlled to prevent overshoot of the output voltage.

# MCP1703

## 6.0 APPLICATION CIRCUITS & ISSUES

### 6.1 Typical Application

The MCP1703 is most commonly used as a voltage regulator. Its low quiescent current and low dropout voltage make it ideal for many battery-powered applications.



**FIGURE 6-1:** Typical Application Circuit.

#### 6.1.1 APPLICATION INPUT CONDITIONS

- Package Type = SOT-23A
- Input Voltage Range = 2.7V to 4.8V
- $V_{IN}$  maximum = 4.8V
- $V_{OUT}$  typical = 1.8V
- $I_{OUT}$  = 50 mA maximum

### 6.2 Power Calculations

#### 6.2.1 POWER DISSIPATION

The internal power dissipation of the MCP1703 is a function of input voltage, output voltage and output current. The power dissipation, as a result of the quiescent current draw, is so low, it is insignificant ( $2.0 \mu A \times V_{IN}$ ). The following equation can be used to calculate the internal power dissipation of the LDO.

#### EQUATION 6-1:

$$P_{LDO} = (V_{IN(MAX)} - V_{OUT(MIN)}) \times I_{OUT(MAX)}$$

Where:

- $P_{LDO}$  = LDO Pass device internal power dissipation
- $V_{IN(MAX)}$  = Maximum input voltage
- $V_{OUT(MIN)}$  = LDO minimum output voltage

The maximum continuous operating junction temperature specified for the MCP1703 is +125°C. To estimate the internal junction temperature of the MCP1703, the total internal power dissipation is multiplied by the thermal resistance from junction to ambient ( $R\theta_{JA}$ ). The thermal resistance from junction to ambient for the SOT-23A pin package is estimated at 336°C/W.

#### EQUATION 6-2:

$$T_{J(MAX)} = P_{TOTAL} \times R\theta_{JA} + T_{AMAX}$$

Where:

- $T_{J(MAX)}$  = Maximum continuous junction temperature
- $P_{TOTAL}$  = Total device power dissipation
- $R\theta_{JA}$  = Thermal resistance from junction-to-ambient
- $T_{AMAX}$  = Maximum ambient temperature

The maximum power dissipation capability for a package can be calculated given the junction-to-ambient thermal resistance and the maximum ambient temperature for the application. The following equation can be used to determine the package maximum internal power dissipation.

#### EQUATION 6-3:

$$P_{D(MAX)} = \frac{(T_{J(MAX)} - T_{A(MAX)})}{R\theta_{JA}}$$

Where:

- $P_{D(MAX)}$  = Maximum device power dissipation
- $T_{J(MAX)}$  = Maximum continuous junction temperature
- $T_{A(MAX)}$  = Maximum ambient temperature
- $R\theta_{JA}$  = Thermal resistance from junction-to-ambient

#### EQUATION 6-4:

$$T_{J(RISE)} = P_{D(MAX)} \times R\theta_{JA}$$

Where:

- $T_{J(RISE)}$  = Rise in device junction temperature over the ambient temperature
- $P_{TOTAL}$  = Maximum device power dissipation
- $R\theta_{JA}$  = Thermal resistance from junction to ambient

#### EQUATION 6-5:

$$T_J = T_{J(RISE)} + T_A$$

Where:

- $T_J$  = Junction temperature
- $T_{J(RISE)}$  = Rise in device junction temperature over the ambient temperature
- $T_A$  = Ambient temperature

## 6.3 Voltage Regulator

Internal power dissipation, junction temperature rise, junction temperature and maximum power dissipation are calculated in the following example. The power dissipation, as a result of ground current, is small enough to be neglected.

### 6.3.1 POWER DISSIPATION EXAMPLE

#### Package

Package Type: SOT-23A

Input Voltage:

$$V_{IN} = 2.7V \text{ to } 4.8V$$

#### LDO Output Voltages and Currents

$$V_{OUT} = 1.8V$$

$$I_{OUT} = 50 \text{ mA}$$

#### Maximum Ambient Temperature

$$T_{A(MAX)} = +40^{\circ}\text{C}$$

#### Internal Power Dissipation

Internal Power dissipation is the product of the LDO output current times the voltage across the LDO ( $V_{IN}$  to  $V_{OUT}$ ).

$$P_{LDO(MAX)} = (V_{IN(MAX)} - V_{OUT(MIN)}) \times I_{OUT(MAX)}$$

$$P_{LDO} = (4.8V - (0.97 \times 1.8V)) \times 50 \text{ mA}$$

$$P_{LDO} = 152.7 \text{ milli-Watts}$$

## Device Junction Temperature Rise

The internal junction temperature rise is a function of internal power dissipation and the thermal resistance from junction to ambient for the application. The thermal resistance from junction to ambient ( $R_{\theta JA}$ ) is derived from an EIA/JEDEC standard for measuring thermal resistance for small surface mount packages. The EIA/JEDEC specification is JESD51-7, "High Effective Thermal Conductivity Test Board for Leaded Surface Mount Packages". The standard describes the test method and board specifications for measuring the thermal resistance from junction to ambient. The actual thermal resistance for a particular application can vary depending on many factors, such as copper area and thickness. Refer to AN792, "A Method to Determine How Much Power a SOT23 Can Dissipate in an Application", (DS00792), for more information regarding this subject.

$$T_{J(RISE)} = P_{TOTAL} \times R_{QJA}$$

$$T_{J(RISE)} = 152.7 \text{ milli-Watts} \times 336.0^{\circ}\text{C/Watt}$$

$$T_{J(RISE)} = 51.3^{\circ}\text{C}$$

## Junction Temperature Estimate

To estimate the internal junction temperature, the calculated temperature rise is added to the ambient or offset temperature. For this example, the worst-case junction temperature is estimated below.

$$T_J = T_{J(RISE)} + T_{A(MAX)}$$

$$T_J = 91.3^{\circ}\text{C}$$

### Maximum Package Power Dissipation at +40°C Ambient Temperature Assuming Minimal Copper Usage.

SOT-23A ( $336.0^{\circ}\text{C/Watt} = R_{\theta JA}$ )

$$P_{D(MAX)} = (+125^{\circ}\text{C} - 40^{\circ}\text{C}) / 336^{\circ}\text{C/W}$$

$$P_{D(MAX)} = 253 \text{ milli-Watts}$$

SOT-89 ( $153.3^{\circ}\text{C/Watt} = R_{\theta JA}$ )

$$P_{D(MAX)} = (+125^{\circ}\text{C} - 40^{\circ}\text{C}) / 153.3^{\circ}\text{C/W}$$

$$P_{D(MAX)} = 0.554 \text{ Watts}$$

SOT-223 ( $62.9^{\circ}\text{C/Watt} = R_{\theta JA}$ )

$$P_{D(MAX)} = (+125^{\circ}\text{C} - 40^{\circ}\text{C}) / 62.9^{\circ}\text{C/W}$$

$$P_{D(MAX)} = 1.35 \text{ Watts}$$

## 6.4 Voltage Reference

The MCP1703 can be used not only as a regulator, but also as a low quiescent current voltage reference. In many microcontroller applications, the initial accuracy of the reference can be calibrated using production test equipment or by using a ratio measurement. When the initial accuracy is calibrated, the thermal stability and line regulation tolerance are the only errors introduced by the MCP1703 LDO. The low-cost, low quiescent current and small ceramic output capacitor are all advantages when using the MCP1703 as a voltage reference.



**FIGURE 6-2:** Using the MCP1703 as a Voltage Reference.

# MCP1703

---

## 6.5 Pulsed Load Applications

For some applications, there are pulsed load current events that may exceed the specified 250 mA maximum specification of the MCP1703. The internal current limit of the MCP1703 will prevent high peak load demands from causing non-recoverable damage. The 250 mA rating is a maximum average continuous rating. As long as the average current does not exceed 250 mA, pulsed higher load currents can be applied to the MCP1703. The typical current limit for the MCP1703 is 500 mA ( $T_A + 25^\circ\text{C}$ ).



## 7.0 PACKAGING INFORMATION

### 7.1 Package Marking Information

3-Pin SOT-23A



3-Lead SOT-89

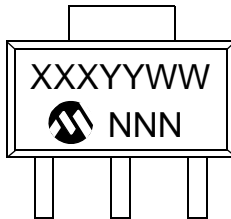

3-Lead SOT-223

Tab is GND



8-Lead DFN (2 x 3)



Standard Options for SOT-23A and SOT-89			
Extended Temp			
Symbol	Voltage *	Symbol	Voltage *
HM	1.2	HT	3.0
HP	1.5	HU	3.3
HQ	1.8	HV	4.0
HR	2.5	HW	5.0
HS	2.8	—	—

\* Custom output voltages available upon request. Contact your local Microchip sales office for more information.

Standard Options for SOT-223			
Extended Temp			
Symbol	Voltage *	Symbol	Voltage *
12	1.2	30	3.0
15	1.5	33	3.3
18	1.8	40	4.0
25	2.5	50	5.0
28	2.8	—	—
Custom			
33	3.3	—	—

\* Custom output voltages available upon request. Contact your local Microchip sales office for more information.

Standard Options for 8-Lead DFN (2 x 3)			
Extended Temp			
Symbol	Voltage *	Symbol	Voltage *
AAU	1.2	AAV	3.3
AAV	1.8	AFR	4.0
AAW	2.5	AAZ	5.0
AAT	3.0	—	—

\* Custom output voltages available upon request. Contact your local Microchip sales office for more information.

Example:



Example:

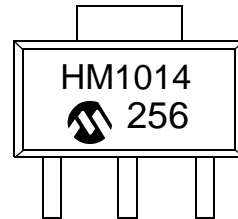

Example:

Tab is GND

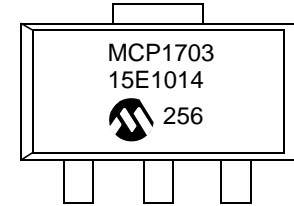

Example:



<b>Legend:</b>	XX...X	Customer-specific information
	Y	Year code (last digit of calendar year)
	YY	Year code (last 2 digits of calendar year)
	WW	Week code (week of January 1 is week '01')
	NNN	Alphanumeric traceability code
	(e3)	Pb-free JEDEC designator for Matte Tin (Sn)
	*	This package is Pb-free. The Pb-free JEDEC designator (e3) can be found on the outer packaging for this package.

**Note:** In the event the full Microchip part number cannot be marked on one line, it will be carried over to the next line, thus limiting the number of available characters for customer-specific information.

# MCP1703

## 3-Lead Plastic Small Outline Transistor (CB) [SOT-23A]

**Note:** For the most current package drawings, please see the Microchip Packaging Specification located at <http://www.microchip.com/packaging>



Dimension Limits	Units	MILLIMETERS		
		MIN	NOM	MAX
Number of Pins	N	3		
Lead Pitch	e	0.95 BSC		
Outside Lead Pitch	e1	1.90 BSC		
Overall Height	A	0.89	–	1.45
Molded Package Thickness	A2	0.90	–	1.30
Standoff	A1	0.00	–	0.15
Overall Width	E	2.10	–	3.00
Molded Package Width	E1	1.20	–	1.80
Overall Length	D	2.70	–	3.10
Foot Length	L	0.15	–	0.60
Foot Angle	$\phi$	0°	–	30°
Lead Thickness	c	0.09	–	0.26
Lead Width	b	0.30	–	0.51

**Notes:**

- Dimensions D and E1 do not include mold flash or protrusions. Mold flash or protrusions shall not exceed 0.127 mm per side.
- Dimensioning and tolerancing per ASME Y14.5M.

BSC: Basic Dimension. Theoretically exact value shown without tolerances.

Microchip Technology Drawing C04-130B

## 3-Lead Plastic Small Outline Transistor (CB) [SOT-23A]

**Note:** For the most current package drawings, please see the Microchip Packaging Specification located at <http://www.microchip.com/packaging>



RECOMMENDED LAND PATTERN

Units		MILLIMETERS		
Dimension Limits		MIN	NOM	MAX
Contact Pitch	E	0.95 BSC		
Contact Pad Spacing	C		2.70	
Contact Pad Width (X3)	X			0.60
Contact Pad Length (X3)	Y			1.00
Distance Between Pads	G	1.70		
Overall Width	Z			3.70

**Notes:**

1. Dimensioning and tolerancing per ASME Y14.5M

BSC: Basic Dimension. Theoretically exact value shown without tolerances.

Microchip Technology Drawing No. C04-2130A

# MCP1703

## 3-Lead Plastic Small Outline Transistor Header (MB) [SOT-89]

**Note:** For the most current package drawings, please see the Microchip Packaging Specification located at <http://www.microchip.com/packaging>



Dimension Limits	Units	MILLIMETERS	
		MIN	MAX
Number of Leads	N	3	
Pitch	e	1.50 BSC	
Outside Lead Pitch	e1	3.00 BSC	
Overall Height	A	1.40	1.60
Overall Width	H	3.94	4.25
Molded Package Width at Base	E	2.29	2.60
Molded Package Width at Top	E1	2.13	2.29
Overall Length	D	4.39	4.60
Tab Length	D1	1.40	1.83
Foot Length	L	0.79	1.20
Lead Thickness	c	0.35	0.44
Lead 2 Width	b	0.41	0.56
Leads 1 & 3 Width	b1	0.36	0.48

**Notes:**

- Dimensions D and E do not include mold flash or protrusions. Mold flash or protrusions shall not exceed 0.127 mm per side.
- Dimensioning and tolerancing per ASME Y14.5M.

BSC: Basic Dimension. Theoretically exact value shown without tolerances.

Microchip Technology Drawing C04-029B

## 3-Lead Plastic Small Outline Transistor Header (MB) [SOT-89]

**Note:** For the most current package drawings, please see the Microchip Packaging Specification located at <http://www.microchip.com/packaging>



RECOMMENDED LAND PATTERN

Units		MILLIMETERS		
		MIN	NOM	MAX
Dimension Limits				
Contact Pitch	E	1.50 BSC		
Contact Pads 1 & 3 Width	X1			0.48
Contact Pad 2 Width	X2			0.56
Heat Slug Pad Width	X3			1.20
Contact Pads 1 & 3 Length	Y1		1.40	
Contact 2 Pad Length	Y2			4.25
-	K	2.60		2.85

**Notes:**

1. Dimensioning and tolerancing per ASME Y14.5M

BSC: Basic Dimension. Theoretically exact value shown without tolerances.

Microchip Technology Drawing No. C04-2029A

# MCP1703

## 3-Lead Plastic Small Outline Transistor (DB) [SOT-223]

**Note:** For the most current package drawings, please see the Microchip Packaging Specification located at <http://www.microchip.com/packaging>



Dimension Limits	Units	MILLIMETERS		
		MIN	NOM	MAX
Number of Leads	N	3		
Lead Pitch	e	2.30 BSC		
Outside Lead Pitch	e1	4.60 BSC		
Overall Height	A	–	–	1.80
Standoff	A1	0.02	–	0.10
Molded Package Height	A2	1.50	1.60	1.70
Overall Width	E	6.70	7.00	7.30
Molded Package Width	E1	3.30	3.50	3.70
Overall Length	D	6.30	6.50	6.70
Lead Thickness	c	0.23	0.30	0.35
Lead Width	b	0.60	0.76	0.84
Tab Lead Width	b2	2.90	3.00	3.10
Foot Length	L	0.75	–	–
Lead Angle	$\phi$	0°	–	10°

**Notes:**

- Dimensions D and E1 do not include mold flash or protrusions. Mold flash or protrusions shall not exceed 0.127 mm per side.
- Dimensioning and tolerancing per ASME Y14.5M.

BSC: Basic Dimension. Theoretically exact value shown without tolerances.

Microchip Technology Drawing C04-032B

## 3-Lead Plastic Small Outline Transistor (DB) [SOT-223]

**Note:** For the most current package drawings, please see the Microchip Packaging Specification located at <http://www.microchip.com/packaging>

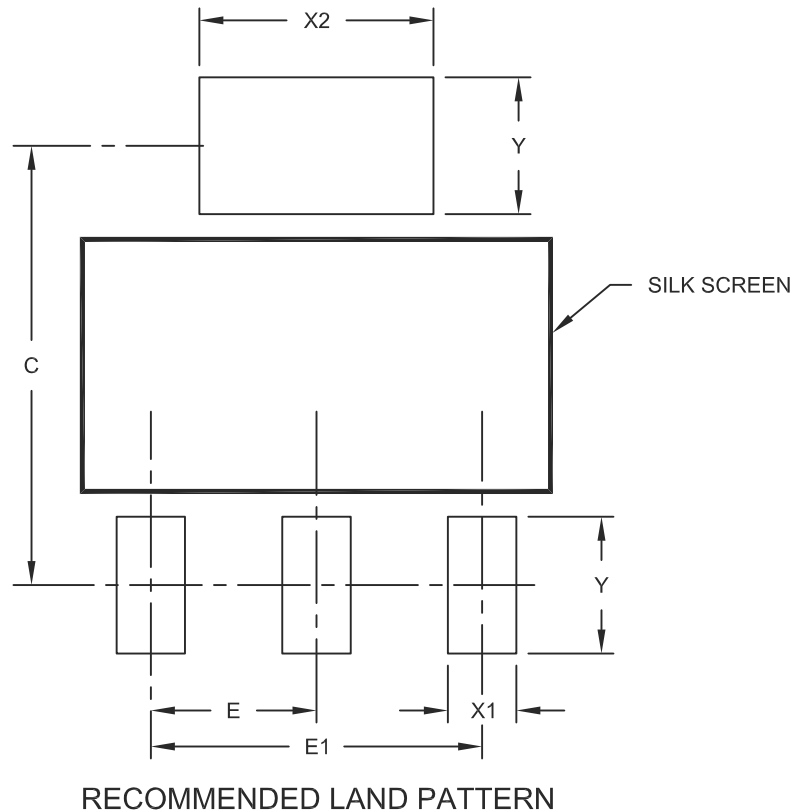

Dimension Limits	Units	MILLIMETERS		
		MIN	NOM	MAX
Contact Pitch	E		2.30 BSC	
Overall Pitch	E1		4.60 BSC	
Contact Pad Spacing	C		6.10	
Contact Pad Width	X1			0.95
Contact Pad Width	X2			3.25
Contact Pad Length	Y			1.90

**Notes:**

1. Dimensioning and tolerancing per ASME Y14.5M

BSC: Basic Dimension. Theoretically exact value shown without tolerances.

Microchip Technology Drawing No. C04-2032A

# MCP1703

## 8-Lead Plastic Dual Flat, No Lead Package (MC) – 2x3x0.9 mm Body [DFN]

**Note:** For the most current package drawings, please see the Microchip Packaging Specification located at <http://www.microchip.com/packaging>

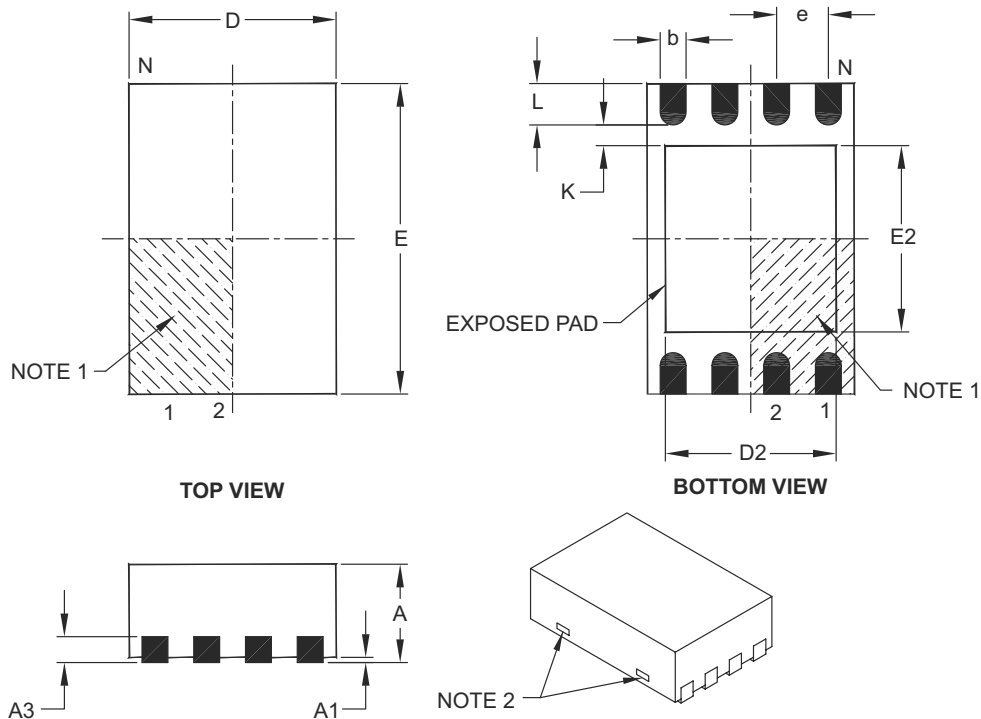

Dimension Limits	Units	MILLIMETERS		
		MIN	NOM	MAX
Number of Pins	N	8		
Pitch	e	0.50 BSC		
Overall Height	A	0.80	0.90	1.00
Standoff	A1	0.00	0.02	0.05
Contact Thickness	A3	0.20 REF		
Overall Length	D	2.00 BSC		
Overall Width	E	3.00 BSC		
Exposed Pad Length	D2	1.30	–	1.55
Exposed Pad Width	E2	1.50	–	1.75
Contact Width	b	0.20	0.25	0.30
Contact Length	L	0.30	0.40	0.50
Contact-to-Exposed Pad	K	0.20	–	–

**Notes:**

- Pin 1 visual index feature may vary, but must be located within the hatched area.
- Package may have one or more exposed tie bars at ends.
- Package is saw singulated.
- Dimensioning and tolerancing per ASME Y14.5M.

BSC: Basic Dimension. Theoretically exact value shown without tolerances.

REF: Reference Dimension, usually without tolerance, for information purposes only.

Microchip Technology Drawing C04-123C



## 8-Lead Plastic Dual Flat, No Lead Package (MC) – 2x3x0.9 mm Body [DFN]

**Note:** For the most current package drawings, please see the Microchip Packaging Specification located at <http://www.microchip.com/packaging>



RECOMMENDED LAND PATTERN

Dimension Limits	Units	MILLIMETERS		
		MIN	NOM	MAX
Contact Pitch	E	0.50 BSC		
Optional Center Pad Width	W2			1.45
Optional Center Pad Length	T2			1.75
Contact Pad Spacing	C1		2.90	
Contact Pad Width (X8)	X1			0.30
Contact Pad Length (X8)	Y1			0.75
Distance Between Pads	G	0.20		

Notes:

1. Dimensioning and tolerancing per ASME Y14.5M

BSC: Basic Dimension. Theoretically exact value shown without tolerances.

Microchip Technology Drawing No. C04-2123A

# MCP1703

---

NOTES:

## APPENDIX A: REVISION HISTORY

### Revision A (June 2007)

- Original Release of this Document.

### Revision F (February 2011)

The following is the list of modifications:

1. Added a new line to Output Voltage Regulation in the [DC Characteristics](#) table.
2. Added [Figure 2-30](#) and [Figure 2-31](#).
3. Added a new line to the Tolerance field in the [Product Identification System](#) section.
4. Added a new custom part to the **Standard Options for SOT-223** table in the [Package Marking Information](#) section.

### Revision E (November 2010)

The following is the list of modifications:

1. Updated the Thermal Resistance Typical value for the SOT-89 package in the [Junction Temperature Estimate](#) section.

### Revision D (September 2009)

The following is the list of modifications:

1. Added the 8-Lead 2x3 DFN package.
2. Updated the Temperature Specification table.
3. Updated [Table 3-1](#).
4. Added [Section 3.4 “Exposed Thermal Pad \(EP\)”](#).
5. Updated the Package Outline Drawings and the information for the 8-Lead 2x3 DFN package.
6. Added the information for the 8-Lead 2x3 DFN package in the Product Identification System section.

### Revision C (June 2009)

The following is the list of modifications:

1. **Absolute Maximum Ratings:** Updated this section.
2. **DC Characteristics** table: Updated.
3. **Temperature Specifications** table: Updated.
4. **Package Information:** Update Package Outline Drawings.

### Revision B (February 2008)

The following is the list of modifications:

1. Updated Temperature Specifications table.
2. Updated [Table 3-1](#).
3. Updated [Section 5.2 “Output”](#).
4. Added SOT-223 Landing Pattern Outline drawing.

# MCP1703

---

NOTES:

## PRODUCT IDENTIFICATION SYSTEM

To order or obtain information, e.g., on pricing or delivery, refer to the factory or the listed sales office.

<u>PART NO.</u>	<u>X-</u>	<u>XX</u>	<u>X</u>	<u>X</u>	<u>X/</u>	<u>XX</u>
Device	Tape and Reel	Output Voltage	Feature Code	Tolerance	Temp.	Package
<p><b>Device:</b> MCP1703: 250 mA, 16V Low Quiescent Current LDO</p> <p><b>Tape and Reel:</b> T = Tape and Reel</p> <p><b>Output Voltage *:</b></p> <ul style="list-style-type: none"> <li>12 = 1.2V "Standard"</li> <li>15 = 1.5V "Standard"</li> <li>18 = 1.8V "Standard"</li> <li>25 = 2.5V "Standard"</li> <li>28 = 2.8V "Standard"</li> <li>30 = 3.0V "Standard"</li> <li>33 = 3.3V "Standard"</li> <li>40 = 4.0V "Standard"</li> <li>50 = 5.0V "Standard"</li> </ul> <p>*Contact factory for other output voltage options.</p> <p><b>Extra Feature Code:</b> 0 = Fixed</p> <p><b>Tolerance:</b></p> <ul style="list-style-type: none"> <li>1 = 1.0% (Custom)</li> <li>2 = 2.0% (Standard)</li> </ul> <p><b>Temperature:</b> E = -40°C to +125°C</p> <p><b>Package Type:</b></p> <ul style="list-style-type: none"> <li>CB = Plastic Small Outline Transistor (SOT-23A) 3-lead,</li> <li>DB = Plastic Small Outline Transistor (SOT-223) 3-lead,</li> <li>MB = Plastic Small Outline Transistor (SOT-89) 3-lead.</li> <li>MC = Plastic Dual Flat, No Lead Package (DFN) 2x3, 8-lead.</li> </ul>						
<p><b>Examples:</b></p> <ul style="list-style-type: none"> <li>a) MCP1703T-1202E/XX: 1.2V Low Quiescent LDO, Tape and Reel</li> <li>b) MCP1703T-1502E/XX: 1.5V Low Quiescent LDO, Tape and Reel</li> <li>c) MCP1703T-1802E/XX: 1.8V Low Quiescent LDO, Tape and Reel</li> <li>d) MCP1703T-2502E/XX: 2.5V Low Quiescent LDO, Tape and Reel</li> <li>e) MCP1703T-2802E/XX: 2.8V Low Quiescent LDO, Tape and Reel</li> <li>f) MCP1703T-3002E/XX: 3.0V Low Quiescent LDO, Tape and Reel</li> <li>g) MCP1703T-3302E/XX: 3.3V Low Quiescent LDO, Tape and Reel</li> <li>h) MCP1703T-3602E/XX: 3.6V Low Quiescent LDO, Tape and Reel</li> <li>i) MCP1703T-4002E/XX: 4.0V Low Quiescent LDO, Tape and Reel</li> <li>j) MCP1703T-5002E/XX: 5.0V Low Quiescent LDO, Tape and Reel</li> </ul> <p>XX = CB for 3LD SOT-23A package            = DB for 3LD SOT-223 package            = MB for 3LD SOT-89 package            = MC for 8LD DFN package.</p>						

# MCP1703

---

NOTES:

---

**Note the following details of the code protection feature on Microchip devices:**

- Microchip products meet the specification contained in their particular Microchip Data Sheet.
- Microchip believes that its family of products is one of the most secure families of its kind on the market today, when used in the intended manner and under normal conditions.
- There are dishonest and possibly illegal methods used to breach the code protection feature. All of these methods, to our knowledge, require using the Microchip products in a manner outside the operating specifications contained in Microchip's Data Sheets. Most likely, the person doing so is engaged in theft of intellectual property.
- Microchip is willing to work with the customer who is concerned about the integrity of their code.
- Neither Microchip nor any other semiconductor manufacturer can guarantee the security of their code. Code protection does not mean that we are guaranteeing the product as “unbreakable.”

Code protection is constantly evolving. We at Microchip are committed to continuously improving the code protection features of our products. Attempts to break Microchip's code protection feature may be a violation of the Digital Millennium Copyright Act. If such acts allow unauthorized access to your software or other copyrighted work, you may have a right to sue for relief under that Act.

---

Information contained in this publication regarding device applications and the like is provided only for your convenience and may be superseded by updates. It is your responsibility to ensure that your application meets with your specifications. MICROCHIP MAKES NO REPRESENTATIONS OR WARRANTIES OF ANY KIND WHETHER EXPRESS OR IMPLIED, WRITTEN OR ORAL, STATUTORY OR OTHERWISE, RELATED TO THE INFORMATION, INCLUDING BUT NOT LIMITED TO ITS CONDITION, QUALITY, PERFORMANCE, MERCHANTABILITY OR FITNESS FOR PURPOSE. Microchip disclaims all liability arising from this information and its use. Use of Microchip devices in life support and/or safety applications is entirely at the buyer's risk, and the buyer agrees to defend, indemnify and hold harmless Microchip from any and all damages, claims, suits, or expenses resulting from such use. No licenses are conveyed, implicitly or otherwise, under any Microchip intellectual property rights.

**Trademarks**

The Microchip name and logo, the Microchip logo, dsPIC, KEELOQ, KEELOQ logo, MPLAB, PIC, PICmicro, PICSTART, PIC<sup>32</sup> logo, rPIC and UNI/O are registered trademarks of Microchip Technology Incorporated in the U.S.A. and other countries.

FilterLab, Hampshire, HI-TECH C, Linear Active Thermistor, MXDEV, MXLAB, SEEVAL and The Embedded Control Solutions Company are registered trademarks of Microchip Technology Incorporated in the U.S.A.

Analog-for-the-Digital Age, Application Maestro, CodeGuard, dsPICDEM, dsPICDEM.net, dsPICworks, dsSPEAK, ECAN, ECONOMONITOR, FanSense, HI-TIDE, In-Circuit Serial Programming, ICSP, Mindi, MiWi, MPASM, MPLAB Certified logo, MPLIB, MPLINK, mTouch, Omniscient Code Generation, PICC, PICC-18, PICDEM, PICDEM.net, PICkit, PICTail, REAL ICE, rLAB, Select Mode, Total Endurance, TSHARC, UniWinDriver, WiperLock and ZENA are trademarks of Microchip Technology Incorporated in the U.S.A. and other countries.

SQTP is a service mark of Microchip Technology Incorporated in the U.S.A.

All other trademarks mentioned herein are property of their respective companies.

© 2011, Microchip Technology Incorporated, Printed in the U.S.A., All Rights Reserved.

 Printed on recycled paper.

ISBN: 978-1-60932-941-9

*Microchip received ISO/TS-16949:2002 certification for its worldwide headquarters, design and wafer fabrication facilities in Chandler and Tempe, Arizona; Gresham, Oregon and design centers in California and India. The Company's quality system processes and procedures are for its PIC® MCUs and dsPIC® DSCs, KEELOQ® code hopping devices, Serial EEPROMs, microperipherals, nonvolatile memory and analog products. In addition, Microchip's quality system for the design and manufacture of development systems is ISO 9001:2000 certified.*

**QUALITY MANAGEMENT SYSTEM  
CERTIFIED BY DNV  
== ISO/TS 16949:2002 ==**



# MICROCHIP

## Worldwide Sales and Service

### AMERICAS

**Corporate Office**  
2355 West Chandler Blvd.  
Chandler, AZ 85224-6199  
Tel: 480-792-7200  
Fax: 480-792-7277  
Technical Support:  
<http://www.microchip.com/support>  
Web Address:  
[www.microchip.com](http://www.microchip.com)

**Atlanta**  
Duluth, GA  
Tel: 678-957-9614  
Fax: 678-957-1455

**Boston**  
Westborough, MA  
Tel: 774-760-0087  
Fax: 774-760-0088

**Chicago**  
Itasca, IL  
Tel: 630-285-0071  
Fax: 630-285-0075

**Cleveland**  
Independence, OH  
Tel: 216-447-0464  
Fax: 216-447-0643

**Dallas**  
Addison, TX  
Tel: 972-818-7423  
Fax: 972-818-2924

**Detroit**  
Farmington Hills, MI  
Tel: 248-538-2250  
Fax: 248-538-2260

**Indianapolis**  
Noblesville, IN  
Tel: 317-773-8323  
Fax: 317-773-5453

**Los Angeles**  
Mission Viejo, CA  
Tel: 949-462-9523  
Fax: 949-462-9608

**Santa Clara**  
Santa Clara, CA  
Tel: 408-961-6444  
Fax: 408-961-6445

**Toronto**  
Mississauga, Ontario,  
Canada  
Tel: 905-673-0699  
Fax: 905-673-6509

### ASIA/PACIFIC

**Asia Pacific Office**  
Suites 3707-14, 37th Floor  
Tower 6, The Gateway  
Harbour City, Kowloon  
Hong Kong  
Tel: 852-2401-1200  
Fax: 852-2401-3431

**Australia - Sydney**  
Tel: 61-2-9868-6733  
Fax: 61-2-9868-6755

**China - Beijing**  
Tel: 86-10-8528-2100  
Fax: 86-10-8528-2104

**China - Chengdu**  
Tel: 86-28-8665-5511  
Fax: 86-28-8665-7889

**China - Chongqing**  
Tel: 86-23-8980-9588  
Fax: 86-23-8980-9500

**China - Hong Kong SAR**  
Tel: 852-2401-1200  
Fax: 852-2401-3431

**China - Nanjing**  
Tel: 86-25-8473-2460  
Fax: 86-25-8473-2470

**China - Qingdao**  
Tel: 86-532-8502-7355  
Fax: 86-532-8502-7205

**China - Shanghai**  
Tel: 86-21-5407-5533  
Fax: 86-21-5407-5066

**China - Shenyang**  
Tel: 86-24-2334-2829  
Fax: 86-24-2334-2393

**China - Shenzhen**  
Tel: 86-755-8203-2660  
Fax: 86-755-8203-1760

**China - Wuhan**  
Tel: 86-27-5980-5300  
Fax: 86-27-5980-5118

**China - Xian**  
Tel: 86-29-8833-7252  
Fax: 86-29-8833-7256

**China - Xiamen**  
Tel: 86-592-2388138  
Fax: 86-592-2388130

**China - Zhuhai**  
Tel: 86-756-3210040  
Fax: 86-756-3210049

### ASIA/PACIFIC

**India - Bangalore**  
Tel: 91-80-3090-4444  
Fax: 91-80-3090-4123

**India - New Delhi**  
Tel: 91-11-4160-8631  
Fax: 91-11-4160-8632

**India - Pune**  
Tel: 91-20-2566-1512  
Fax: 91-20-2566-1513

**Japan - Yokohama**  
Tel: 81-45-471- 6166  
Fax: 81-45-471-6122

**Korea - Daegu**  
Tel: 82-53-744-4301  
Fax: 82-53-744-4302

**Korea - Seoul**  
Tel: 82-2-554-7200  
Fax: 82-2-558-5932 or  
82-2-558-5934

**Malaysia - Kuala Lumpur**  
Tel: 60-3-6201-9857  
Fax: 60-3-6201-9859

**Malaysia - Penang**  
Tel: 60-4-227-8870  
Fax: 60-4-227-4068

**Philippines - Manila**  
Tel: 63-2-634-9065  
Fax: 63-2-634-9069

**Singapore**  
Tel: 65-6334-8870  
Fax: 65-6334-8850

**Taiwan - Hsin Chu**  
Tel: 886-3-6578-300  
Fax: 886-3-6578-370

**Taiwan - Kaohsiung**  
Tel: 886-7-213-7830  
Fax: 886-7-330-9305

**Taiwan - Taipei**  
Tel: 886-2-2500-6610  
Fax: 886-2-2508-0102

**Thailand - Bangkok**  
Tel: 66-2-694-1351  
Fax: 66-2-694-1350

### EUROPE

**Austria - Wels**  
Tel: 43-7242-2244-39  
Fax: 43-7242-2244-393

**Denmark - Copenhagen**  
Tel: 45-4450-2828  
Fax: 45-4485-2829

**France - Paris**  
Tel: 33-1-69-53-63-20  
Fax: 33-1-69-30-90-79

**Germany - Munich**  
Tel: 49-89-627-144-0  
Fax: 49-89-627-144-44

**Italy - Milan**  
Tel: 39-0331-742611  
Fax: 39-0331-466781

**Netherlands - Drunen**  
Tel: 31-416-690399  
Fax: 31-416-690340

**Spain - Madrid**  
Tel: 34-91-708-08-90  
Fax: 34-91-708-08-91

**UK - Wokingham**  
Tel: 44-118-921-5869  
Fax: 44-118-921-5820

02/18/11



# Mouser Electronics

Authorized Distributor

Click to View Pricing, Inventory, Delivery & Lifecycle Information:

## Microchip:

[MCP1703-2802E/DB](#) [MCP1703-4002E/DB](#) [MCP1703T-2802E/CB](#) [MCP1703T-4002E/CB](#) [MCP1703T-4002E/DB](#)  
[MCP1703T-4002E/MB](#) [MCP1703T-2502E/CB](#) [MCP1703RT-5002E/MB](#) [MCP1703T-2402E/DB](#) [MCP1703T-3602E/CB](#)  
[MCP1703T-4502E/CB](#) [MCP1703T-2402E/CB](#)