

THIS DOCUMENT IS THE PROPERTY OF
KEYSTONE ELECTRONICS CORP. AND
SHALL NOT BE REPRODUCED, DISTRIBUTED
OR USED AS A BASIS FOR MANUFACTURE
WITHOUT PRIOR WRITTEN PERMISSION
FROM KEYSTONE ELECTRONICS CORP.

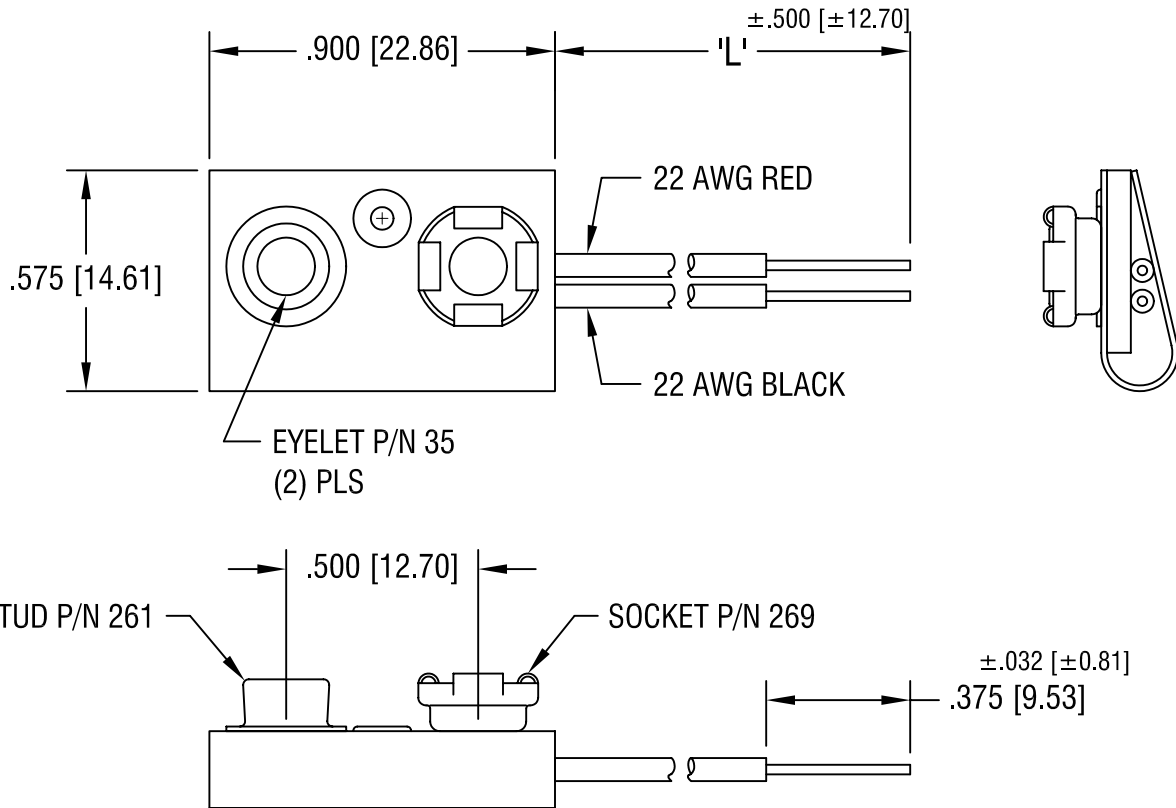

NOTES:

1. MAT'L -

WIRE: 22 AWG, 1061 UL/CSA APPROVED
.052 [1.32] O.D. PVC INSULATION.
RED WIRE SOLDERED TO FEMALE CONTACT;
BLACK WIRE TO MALE CONTACT.

2. BASE:

MAT'L - .062 [1.57] TH'K FIBRE
COVER:
MAT'L - .015 [0.38] TH'K FIBRE
CONTACT:
MAT'L - STEEL
FINISH - NICKEL PLATE
EYELET:
MAT'L - BRASS
FINISH - TIN PLATE

PART NO.	'L' DIM.
83-4	4.000 [101.60]
83	6.500 [165.10]
83-8	8.000 [203.20]

KEYSTONE ELECTRONICS CORP.			
ASTORIA, N.Y. 11105-2017			
PART NAME			
'9' VOLT BATTERY STRAP			
MATERIAL			
AS NOTED			
FINISH		DRN BY	DATE
AS NOTED		BOONE	5.17.96
		APPD	SCALE
		LN	2X
TOLERANCES	INCH [MM]	CODE	DWG NO.
DECIMAL	± .010 [± 0.25]	C/M	83-
ANGULAR	± 1°		
UNLESS OTHERWISE SPECIFIED			

DATE	DESCRIPTION	REV.

Mouser Electronics

Authorized Distributor

Click to View Pricing, Inventory, Delivery & Lifecycle Information:

[Keystone Electronics:](#)

[83-8](#)