

## Product Summary

MBR2045CT / MBRF2045CT (Per Leg)

$V_{RRM}$ (V)	$I_O$ (A)	$V_F$ (MAX) (V) @ +25°C	$I_R$ (MAX) (mA) @ +25°C
45	10	0.64	0.1

MBR2060CT / MBRF2060CT (Per Leg)

$V_{RRM}$ (V)	$I_O$ (A)	$V_F$ (MAX) (V) @ +25°C	$I_R$ (MAX) (mA) @ +25°C
60	10	0.81	0.1

## Features and Benefits

- Guard Ring Die Construction for Transient Protection.
- High Surge Current Capability.
- Low Forward Voltage Drop.
- **Lead-Free Finish; RoHS Compliant (Notes 1 & 2)**
- **Halogen and Antimony Free. "Green" Device (Note 3)**
- **Qualified to AEC-Q101 Standards for High Reliability**

## Description and Applications

This Schottky Barrier Rectifier is designed to meet the general requirements of commercial applications. It is ideally suited for use as:

- Polarity Protection Diode
- Re-Circulating Diode
- Switching Diode

## Mechanical Data

- Case: TO-220AB, ITO-220AB
- Case Material: Molded Plastic, "Green" Molding Compound. UL Flammability Classification Rating 94V-0
- Moisture Sensitivity: Level 1 per J-STD-020
- Terminals: Finish - Matte Tin Annealed over Copper Leadframe. Solderable per MIL-STD-202, Method 208 <sup>(3)</sup>
- Polarity: See Below
- Weight: TO-220AB – 1.95 grams (Approximate)  
ITO-220AB – 1.69 grams (Approximate)

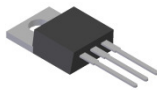

TO-220AB  
Top View

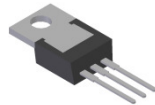

TO-220AB  
Bottom View

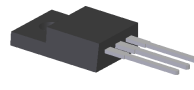

ITO-220AB  
Top View

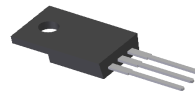

ITO-220AB  
Bottom View

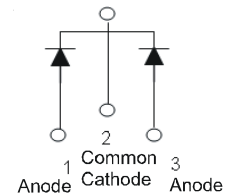

Package Pin Out  
Configuration

## Ordering Information (Note 4)

Part Number	Case	Packaging
MBR2045CT-LJ	TO-220AB (Type C)	50 pieces/tube
MBRF2045CT-LJ	ITO-220AB (TO220F-3)	50 pieces/tube
MBR2060CT-LJ	TO-220AB (Type C)	50 pieces/tube
MBRF2060CT-LJ	ITO-220AB (TO220F-3)	50 pieces/tube

- Notes:
1. EU Directive 2002/95/EC (RoHS) & 2011/65/EU (RoHS 2) compliant. All applicable RoHS exemptions applied.
  2. See [http://www.diodes.com/quality/lead\\_free.html](http://www.diodes.com/quality/lead_free.html) for more information about Diodes Incorporated's definitions of Halogen- and Antimony-free, "Green" and Lead-free.
  3. Halogen- and Antimony-free "Green" products are defined as those which contain <900ppm bromine, <900ppm chlorine (<1500ppm total Br + Cl) and <1000ppm antimony compounds.
  4. For packaging details, go to our website at <http://www.diodes.com/products/packages.html>.

## Marking Information

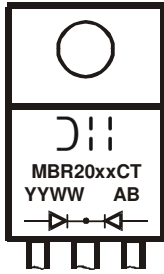

MBR20xxCT = Product Type Marking Code  
 AB = Foundry and Assembly Code  
 YYWW = Date Code Marking  
 YY = Last two Digits of Year (ex: 13 = 2013)  
 WW = Week (01 - 53)



MBRF20xxCT = Product Type Marking Code  
 AB = Foundry and Assembly Code  
 YYWW = Date Code Marking  
 YY = Last two Digits of Year (ex: 13 = 2013)  
 WW = Week (01 - 53)

## Maximum Ratings (Per Leg) (@T<sub>A</sub> = +25°C, unless otherwise specified.)

Single phase, half wave, 60Hz, resistive or inductive load.  
 For capacitance load, derate current by 20%.

Characteristic	Symbol	Value	Unit
Peak Repetitive Reverse Voltage			
Working Peak Reverse Voltage	V <sub>RRM</sub>		V
DC Blocking Voltage	V <sub>RWM</sub>	45	
MBR2045CT / MBRF2045CT	V <sub>RM</sub>	60	
MBR2060CT / MBRF2060CT			
Average Rectified Output Current (Per Leg)		10	A
(Total)	I <sub>O</sub>	20	
Non-Repetitive Peak Forward Surge Current 8.3ms		180	A
Single Half Sine-Wave Superimposed on Rated Load	I <sub>FSM</sub>		

## Thermal Characteristics (Per Leg)

Characteristic	Symbol	Value	Unit
Typical Thermal Resistance, Junction to Case (Note 5)			
Package = TO-220AB	R <sub>θJC</sub>	2	°C/W
Package = ITO-220AB		4	
Typical Thermal Resistance, Junction to Ambient (Note 5)			
Package = TO-220AB	R <sub>θJA</sub>	15	°C/W
Package = ITO-220AB		25	
Operating and Storage Temperature Range	T <sub>J</sub> , T <sub>STG</sub>	-55 to +150	°C

## Electrical Characteristics (Per Leg) (@T<sub>A</sub> = +25°C, unless otherwise specified.)

Characteristic	Symbol	Min	Typ	Max	Unit	Test Condition
MBR2045CT / MBRF2045CT			0.58	0.64		I <sub>F</sub> = 10A, T <sub>J</sub> = +25°C
Forward Voltage Drop	V <sub>F</sub>	—	—	0.57	V	I <sub>F</sub> = 10A, T <sub>J</sub> = +125°C
MBR2060CT / MBRF2060CT			0.75	0.81		I <sub>F</sub> = 10A, T <sub>J</sub> = +25°C
Forward Voltage Drop	V <sub>F</sub>	—	—	0.69	V	I <sub>F</sub> = 10A, T <sub>J</sub> = +125°C
Leakage Current (Note 6)				0.1		V <sub>R</sub> = Rated V, T <sub>J</sub> = +25°C
at Rated DC Blocking Voltage	I <sub>R</sub>	—	—	15	mA	V <sub>R</sub> = Rated V, T <sub>J</sub> = +125°C

Notes: 5. Device mounted on heat sink (45mm x 20mm x 12mm), with minimum recommended pad layout per <http://www.diodes.com>.  
 6. Short duration pulse test used to minimize self-heating effect.

**MBR2045CT / MBRF2045CT**

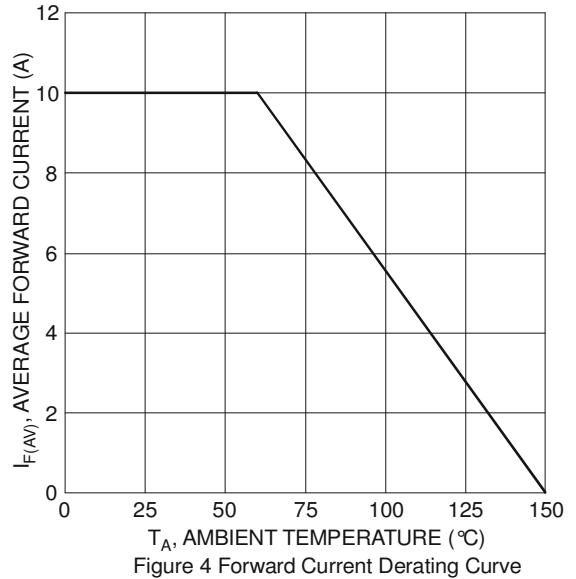
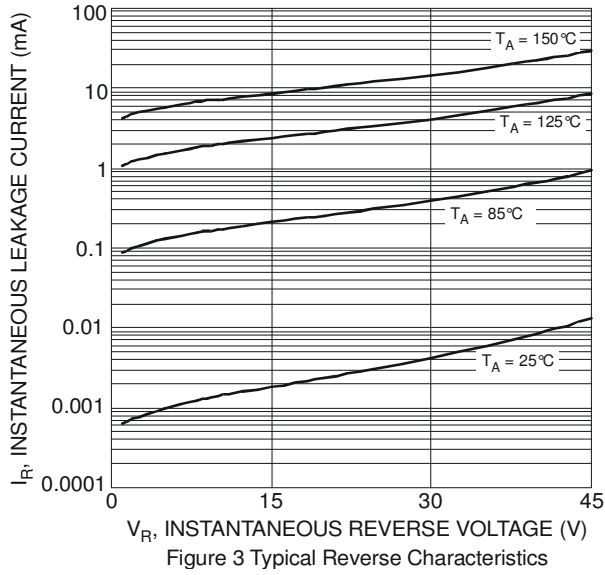
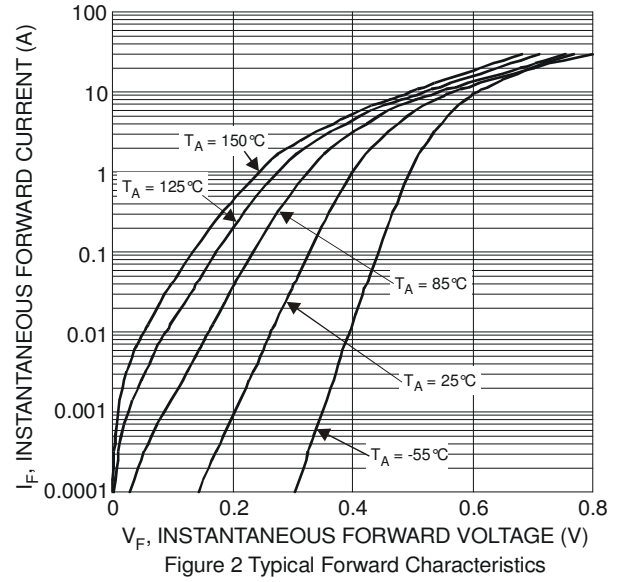
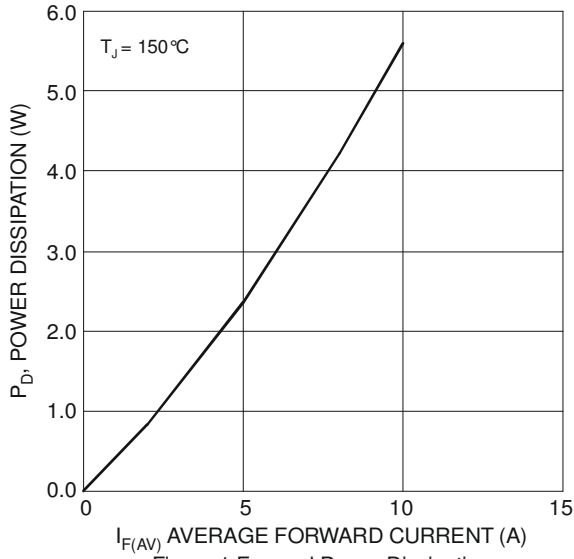

**MBR2060CT / MBRF2060CT**

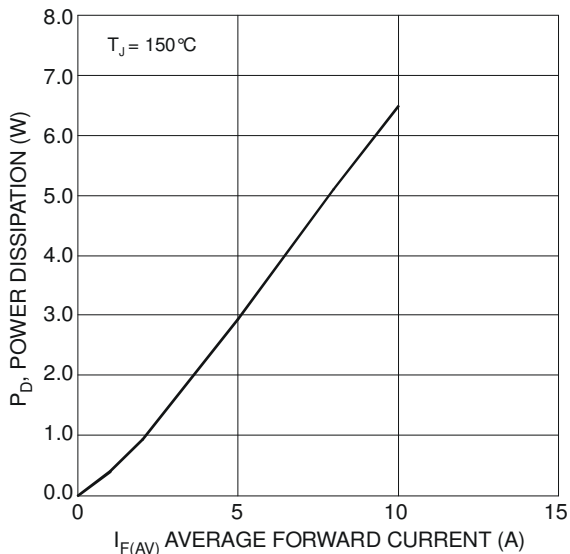

Figure 1 Forward Power Dissipation

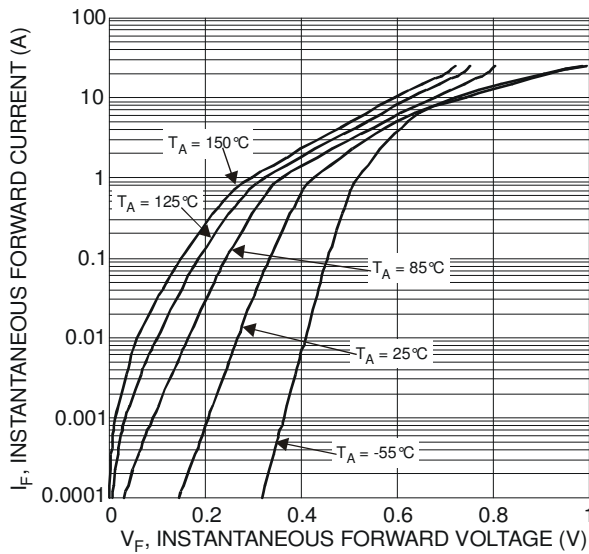

Figure 2 Typical Forward Characteristics

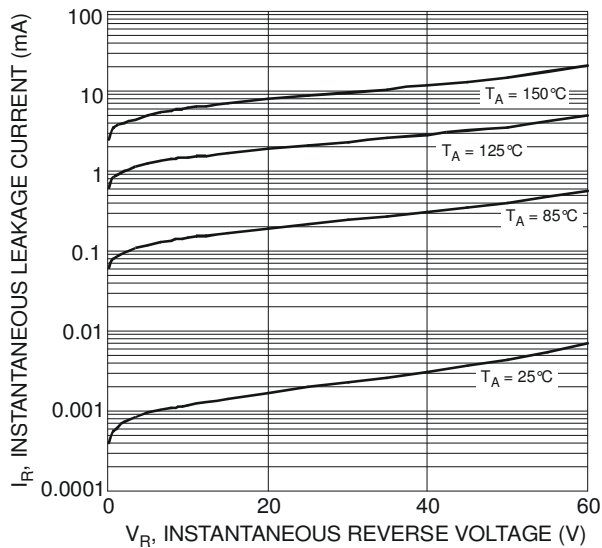

Figure 3 Typical Reverse Characteristics

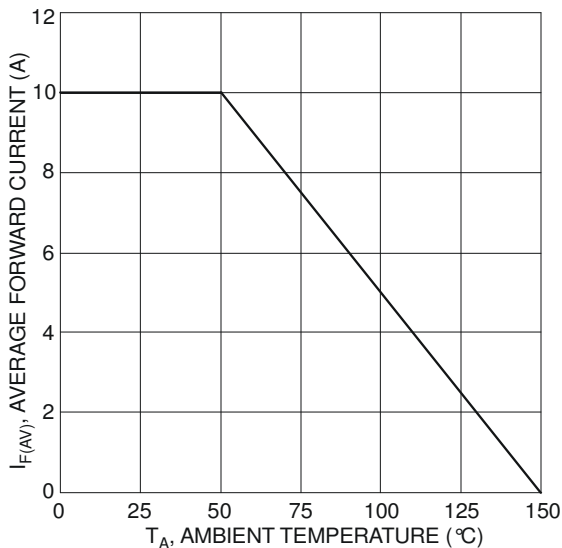
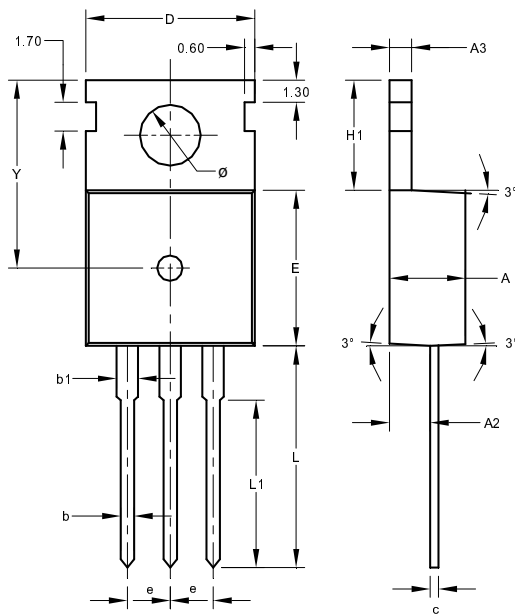

Figure 4 Forward Current Derating Curve

**Package Outline Dimensions**

Please see AP02002 at <http://www.diodes.com/datasheets/ap02002.pdf> for the latest version.



TO220AB (Type C)			
Dim	Min	Max	Typ
A	4.40	4.60	4.500
A2	2.20	2.50	2.400
A3	1.20	1.40	1.300
b	0.700	0.900	-
b1	1.170	1.390	1.270
c	0.400	0.600	-
D	9.800	10.200	-
E	9.000	9.400	-
e	-	-	2.54
H1	6.300	6.700	-
L	12.600	13.600	-
L1	9.600	10.600	-
Y	-	-	11.100
Ø	3.560	3.640	-
All Dimensions in mm			

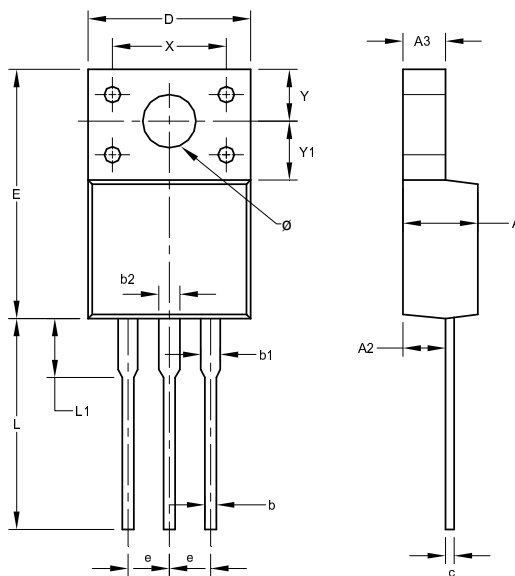

ITO220AB (TO220F-3)			
Dim	Min	Max	Typ
A	4.30	4.90	-
A2	2.52	2.92	-
A3	2.35	2.90	-
b	0.55	0.90	-
b1	1.00	1.40	-
b2	1.10	1.50	-
c	0.45	0.60	-
D	9.70	10.30	-
E	14.70	16.00	-
e	-	-	2.54
L	12.50	13.50	-
L1	2.79	4.50	-
X	6.90	7.10	-
Y	3.00	3.40	-
Y1	3.37	3.90	-
Ø	3.00	3.55	-
All Dimensions in mm			

#### **IMPORTANT NOTICE**

DIODES INCORPORATED MAKES NO WARRANTY OF ANY KIND, EXPRESS OR IMPLIED, WITH REGARDS TO THIS DOCUMENT, INCLUDING, BUT NOT LIMITED TO, THE IMPLIED WARRANTIES OF MERCHANTABILITY AND FITNESS FOR A PARTICULAR PURPOSE (AND THEIR EQUIVALENTS UNDER THE LAWS OF ANY JURISDICTION).

Diodes Incorporated and its subsidiaries reserve the right to make modifications, enhancements, improvements, corrections or other changes without further notice to this document and any product described herein. Diodes Incorporated does not assume any liability arising out of the application or use of this document or any product described herein; neither does Diodes Incorporated convey any license under its patent or trademark rights, nor the rights of others. Any Customer or user of this document or products described herein in such applications shall assume all risks of such use and will agree to hold Diodes Incorporated and all the companies whose products are represented on Diodes Incorporated website, harmless against all damages.

Diodes Incorporated does not warrant or accept any liability whatsoever in respect of any products purchased through unauthorized sales channel. Should Customers purchase or use Diodes Incorporated products for any unintended or unauthorized application, Customers shall indemnify and hold Diodes Incorporated and its representatives harmless against all claims, damages, expenses, and attorney fees arising out of, directly or indirectly, any claim of personal injury or death associated with such unintended or unauthorized application.

Products described herein may be covered by one or more United States, international or foreign patents pending. Product names and markings noted herein may also be covered by one or more United States, international or foreign trademarks.

This document is written in English but may be translated into multiple languages for reference. Only the English version of this document is the final and determinative format released by Diodes Incorporated.

#### **LIFE SUPPORT**

Diodes Incorporated products are specifically not authorized for use as critical components in life support devices or systems without the express written approval of the Chief Executive Officer of Diodes Incorporated. As used herein:

A. Life support devices or systems are devices or systems which:

1. are intended to implant into the body, or
2. support or sustain life and whose failure to perform when properly used in accordance with instructions for use provided in the labeling can be reasonably expected to result in significant injury to the user.

B. A critical component is any component in a life support device or system whose failure to perform can be reasonably expected to cause the failure of the life support device or to affect its safety or effectiveness.

Customers represent that they have all necessary expertise in the safety and regulatory ramifications of their life support devices or systems, and acknowledge and agree that they are solely responsible for all legal, regulatory and safety-related requirements concerning their products and any use of Diodes Incorporated products in such safety-critical, life support devices or systems, notwithstanding any devices- or systems-related information or support that may be provided by Diodes Incorporated. Further, Customers must fully indemnify Diodes Incorporated and its representatives against any damages arising out of the use of Diodes Incorporated products in such safety-critical, life support devices or systems.

Copyright © 2015, Diodes Incorporated

**[www.diodes.com](http://www.diodes.com)**

# Mouser Electronics

Authorized Distributor

Click to View Pricing, Inventory, Delivery & Lifecycle Information:

[Diodes Incorporated:](#)

[MBRF2060CT-I](#) [MBRF2060CT-JT](#) [MBRF2045CT-JT](#) [MBRF2045CT](#) [MBR2045CT-LJ-01](#)