

THIS DOCUMENT IS THE PROPERTY OF
KEYSTONE ELECTRONICS CORP. AND
SHALL NOT BE REPRODUCED, DISTRIBUTED
OR USED AS A BASIS FOR MANUFACTURE
WITHOUT PRIOR WRITTEN PERMISSION
FROM KEYSTONE ELECTRONICS CORP.

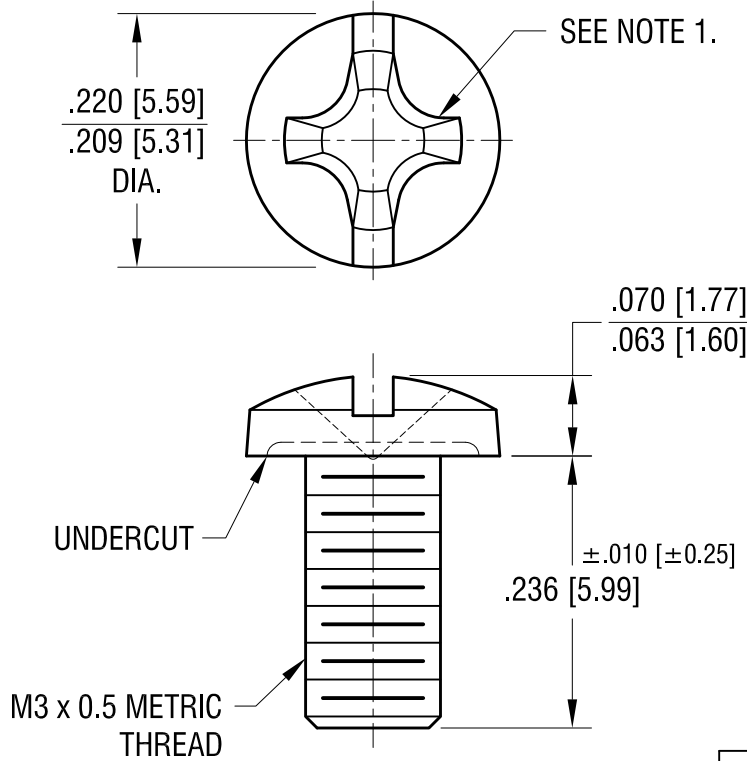
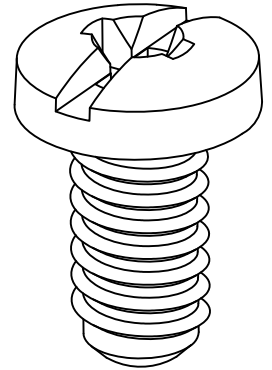

PART NO.	HEAD COLOR
9191-2	RED
9191-3	BLACK
9191-4	WHITE
9191-5	BLUE
9191-6	GREEN
9191-7	YELLOW

NOTE:

1. TO ACCEPT STANDARD SLOT OR PHILLIPS DRIVE.
2. HEAD OF SCREW IS POWDER COATED WITH COLOR AS INDICATED IN CHART.

KEYSTONE ELECTRONICS CORP.
www.keyelco.com • ASTORIA, N.Y. 11105-2017 • Tel (718) 956-8900

PART NAME
METRIC COMBINATION BINDING HD SCREW

MATERIAL
BRASS

FINISH NICKEL PLATE	DRN BY NT	DATE 1.26.10
	APP'D LN	SCALE 6X

TOLERANCES INCH [MM]
DECIMAL ± .005 [± 0.13]
ANGULAR ± 1°
UNLESS OTHERWISE SPECIFIED

CODE
C

DWG NO.
9191-2 - 9191-7

DATE	DESCRIPTION	REV.

Mouser Electronics

Authorized Distributor

Click to View Pricing, Inventory, Delivery & Lifecycle Information:

[Keystone Electronics:](#)

[9191-3](#)