



120×120×38 mm

San Ace 120 9GV type

General Specifications

- Material Frame: Plastic (Flammability: UL 94V-0), Impeller: Plastic (Flammability: UL 94V-1)
- Expected life See the table below. (L10 life: 90% survival rate for continuous operation in free air at 60°C, rated voltage)
- Motor protection function Locked rotor burnout protection, Reverse polarity protection
For details, please refer to p. 547.
- Dielectric strength 50/60 Hz, 500 VAC, for 1 minute (between lead wire conductors and frame)
- Insulation resistance 10 MΩ or more with a 500 VDC megger (between lead wire conductors and frame)
- Sound pressure level (SPL) At 1 m away from the air inlet
- Storage temperature -30 to +70°C (Non-condensing)
- Lead wire ⊕Red ⊖Black Sensor Yellow Control Brown
- Mass 360 g

Specifications

The models listed below **have ribs and pulse sensors with PWM control function.** For models without ribs, append "1" to the end of model numbers.

Model no.	Rated voltage [V]	Operating voltage range [V]	PWM duty cycle* [%]	Rated current [A]	Rated input [W]	Rated speed [min ⁻¹]	Max. airflow [m ³ /min] [CFM]	Max. static pressure [Pa] [inchH ₂ O]	SPL [dB (A)]	Operating temperature [°C]	Expected life [h]
9GV1212P1J01	12	10.2 to 13.8	100	3.0	36.0	6400	6.35 224.0	360.0 1.45	64	-20 to +70	40000/60°C
			0	0.19	2.28	1500	1.49 52.6	19.8 0.08	33		
9GV1212P1G01	12	10.2 to 13.8	100	2.1	25.2	5500	5.45 192.6	265 1.06	60		
			0	0.19	2.28	1500	1.49 52.6	19.8 0.08	33		
9GV1224P1J01**	24	20.4 to 27.6	100	1.5	36.0	6400	6.35 224.0	360 1.45	64		
9GV1224P1H01**			100	0.8	19.2	5200	5.16 182.3	237 0.95	58		
9GV1248P1J01	48	40.8 to 55.2	100	0.75	36.0	6400	6.35 224.0	360.0 1.45	64		
			0	0.06	2.88	1500	1.49 52.6	26.1 0.106	33		

* PWM frequency: 25 kHz ** Fan does not rotate when PWM duty cycle is 0%.

The following sensor and control options are available for selection.

Differs according to the model. Refer to the table on pp. 574 to 575. Without sensor Pulse sensor Lock sensor

Airflow - Static Pressure Characteristics / PWM Duty - Speed Characteristics Example

9GV1212P1J01 With pulse sensor with PWM control function

PWM duty cycle

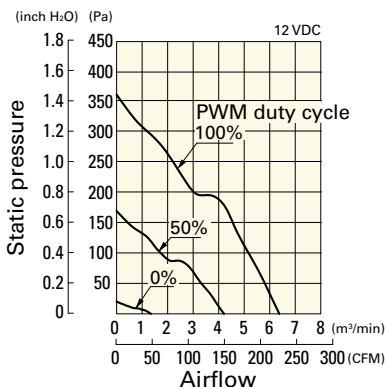

Operating voltage range

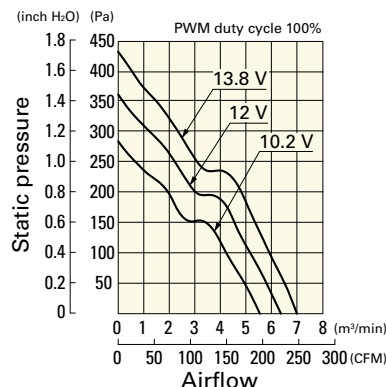

PWM duty - Speed characteristics example

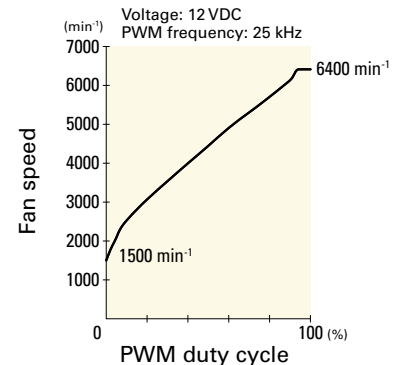

Airflow - Static Pressure Characteristics / PWM Duty - Speed Characteristics Example

9GV1212P1G01 With pulse sensor with PWM control function

PWM duty cycle

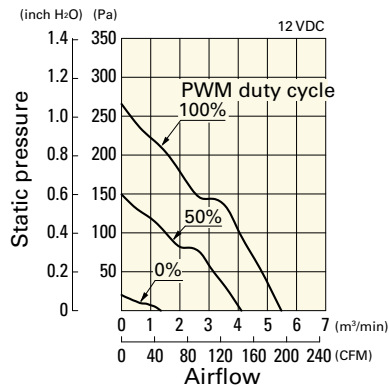

Operating voltage range

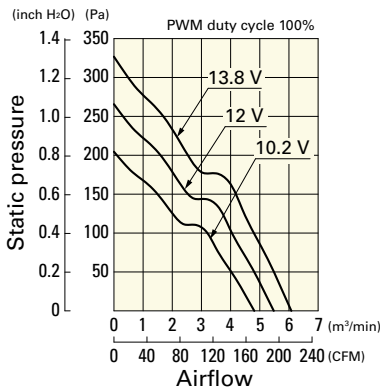

PWM duty - Speed characteristics example

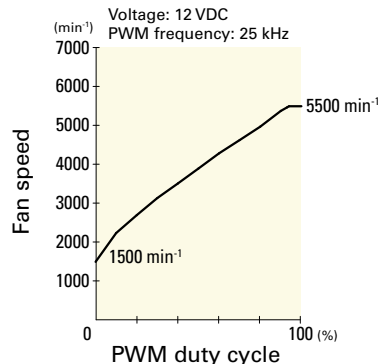

9GV1224P1J01 With pulse sensor with PWM control function

PWM duty cycle

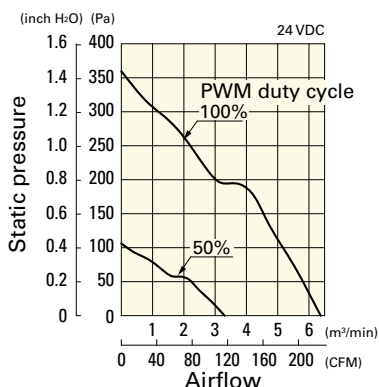

Operating voltage range

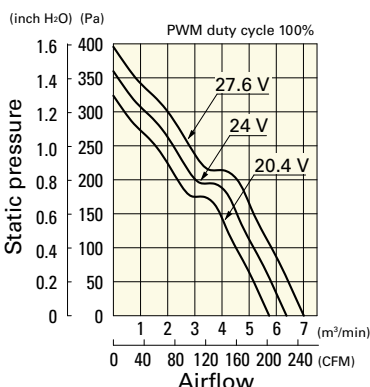

PWM duty - Speed characteristics example

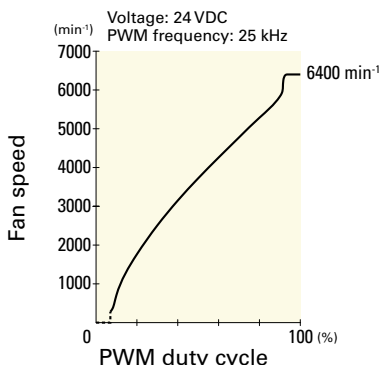

9GV1224P1H01 With pulse sensor with PWM control function

PWM duty cycle

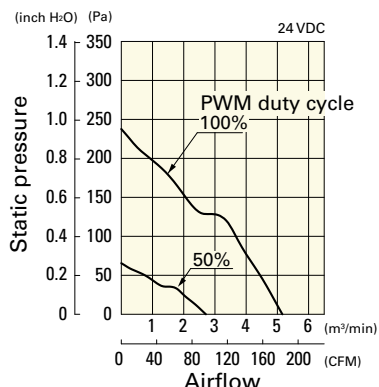

Operating voltage range

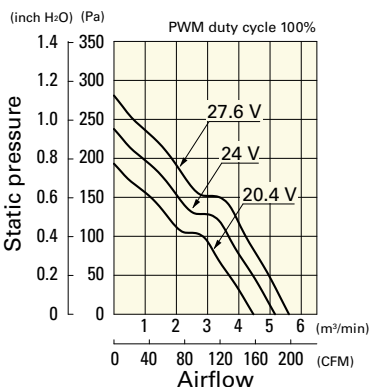

PWM duty - Speed characteristics example

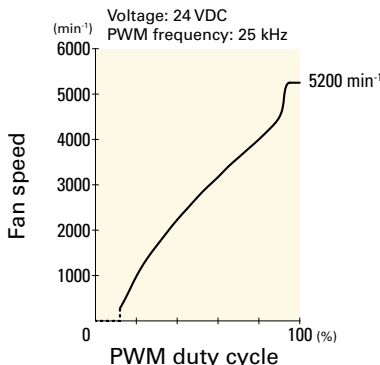

9GV1248P1J01 With pulse sensor with PWM control function

PWM duty cycle

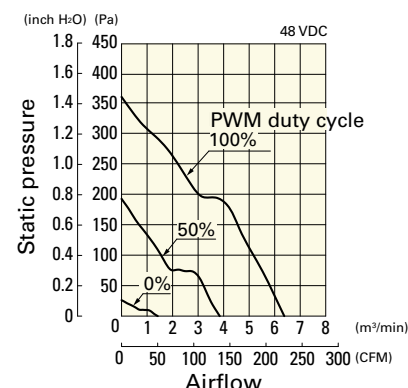

Operating voltage range

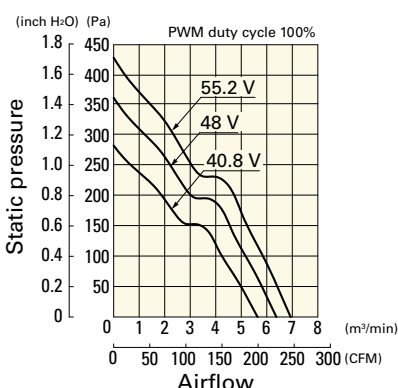

PWM duty - Speed characteristics example

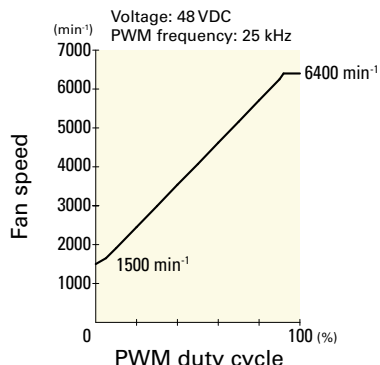

Dimensions (unit: mm) (With ribs)

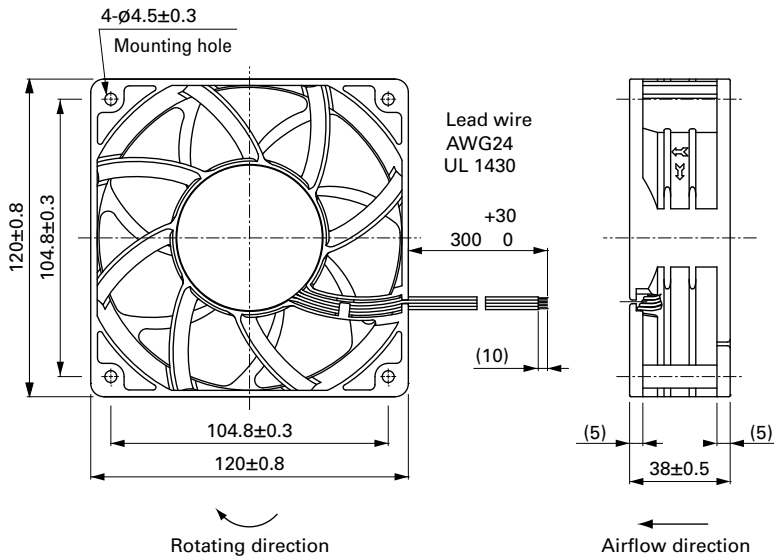

Reference Dimensions of Mounting Holes and Vent Opening (unit: mm)

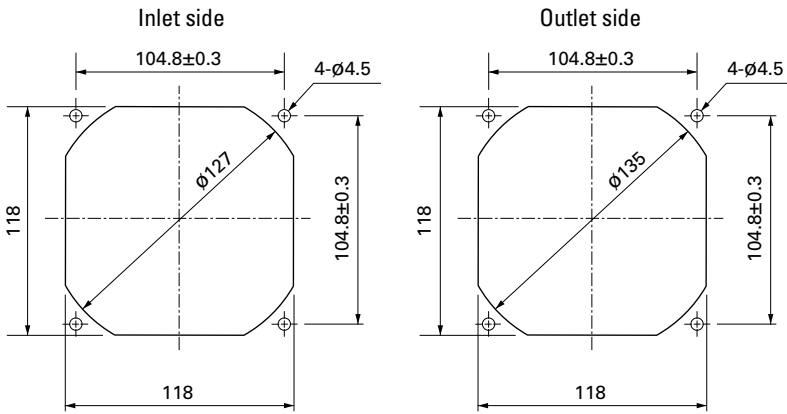

Options

Finger guards

page: p. 533

Model no.: 109-019E, 109-019K, 109-019C, 109-019H

Resin finger guards

page: p. 539

Model no.: 109-1000G

Resin filter kits

page: p. 540

Model no.: 109-1000F13 (13PPI), 109-1000F20 (20PPI),
109-1000F30 (30PPI), 109-1000F40 (40PPI)

Mouser Electronics

Authorized Distributor

Click to View Pricing, Inventory, Delivery & Lifecycle Information:

Sanyo Denki:

[9GV1212J101](#) [9GV1224P1J011](#) [9GV1212P1J011](#) [9GV1224P1H01](#) [9GV1248P1J01](#) [9GV1212P1J01](#)
[9GV1224P1H011](#) [9GV1224P1J01](#) [9GV1212P1G011](#) [9GV1212P1G01](#) [9GV1224J102](#) [9GV1224H101](#)
[9GV1248P1B10](#) [9GV1212J102](#) [9GV1248J101](#) [9GV1248J102](#) [9GV1224H102](#) [9GV1248P1J011](#) [9GV1248J1011](#)
[9GV1224J1011](#) [9GV1224J101](#) [9GV1212G1011](#) [9GV1224H1011](#) [9GV1224H1021](#) [9GV1224J1021](#) [9GV1224J1D011](#)
[9GV1212J1011](#) [9GV1248J1021](#) [9GV1212J1021](#) [9GV1224H1D011](#) [9GV1224H1D01](#) [9GV1248J1D01](#)
[9GV1212J1D01](#) [9GV1212G1D011](#) [9GV1224J1D01](#)