

# Sicma-2



## 2.8 mm female and male terminals

### Features

- Sicma technology
- One-piece construction
- 4 contact points
- 5 mm pitch
- High current carrying capacity
- Low contact mating force
- Compatible with a large range of connector sealing technologies (single wire sealing, mat-seal)
- Suitable for secondary lock
- Also suitable for 3 mm tabs
- Selective gold-plated versions available

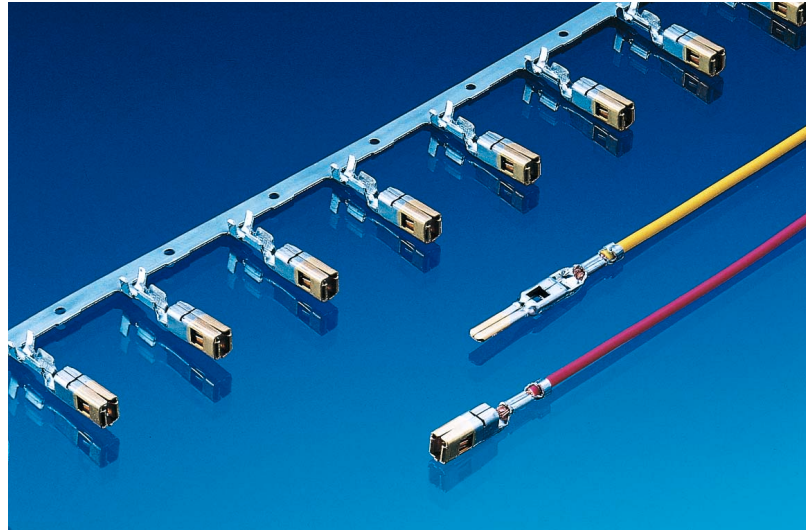

### Performance characteristics

- Contact resistance: < 1 m $\Omega$
- Contact mating force: < 7 N
- Contact unmating force: < 5 N
- Current carrying capacity
 

at 23°C up to approx.:	35 A
at 85°C up to approx.:	23 A
at 100°C up to approx.:	20 A
at 125°C up to approx.:	11 A

### Packing

- No. of terminals per reel: Consult us
- No. of reels per packing: Consult us

### Tooling

- Manual crimping tool: Consult us
- Mini applicator: Consult us

Part Numbers	Type	Wire size range (in mm <sup>2</sup> )		Insulation $\varnothing$ (in mm)	Material	Plating
		Min.	Max.	Max.		
211 CC3S1120	Female	0.35	0.75	2.20	CuMg	Sn
211 CC3S2120	Female	1.00	2.50	3.00	CuMg	Sn
211 CC3S3120	Female	3.00	5.00	3.90	CuMg	Sn
211 CC3S1220	Female	0.35	0.75	2.20	CuMg	Au 1.27 $\mu$ m
211 CC3S2220	Female	1.00	2.50	3.00	CuMg	Au 1.27 $\mu$ m
211 CL3S1120	Male	0.35	0.75	2.20	CuSn	Sn
211 CL3S2120	Male	1.00	2.50	3.00	CuSn	Sn
211 CL3S3120	Male	3.00	5.00	3.90	CuSn	Sn
211 CL3S1220	Male	0.35	0.75	2.20	CuSn	Au 1.27 $\mu$ m
211 CL3S2220	Male	1.00	2.50	3.00	CuSn	Au 1.27 $\mu$ m

# Sicma-2

## 2.8 mm female and male terminals

### Dimensional characteristics

Notes :

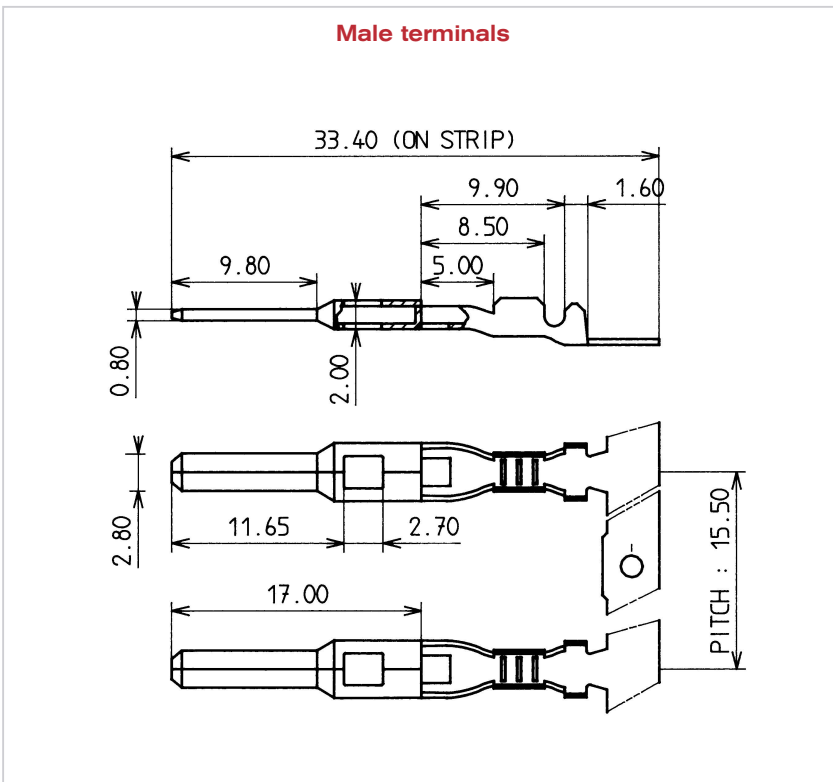
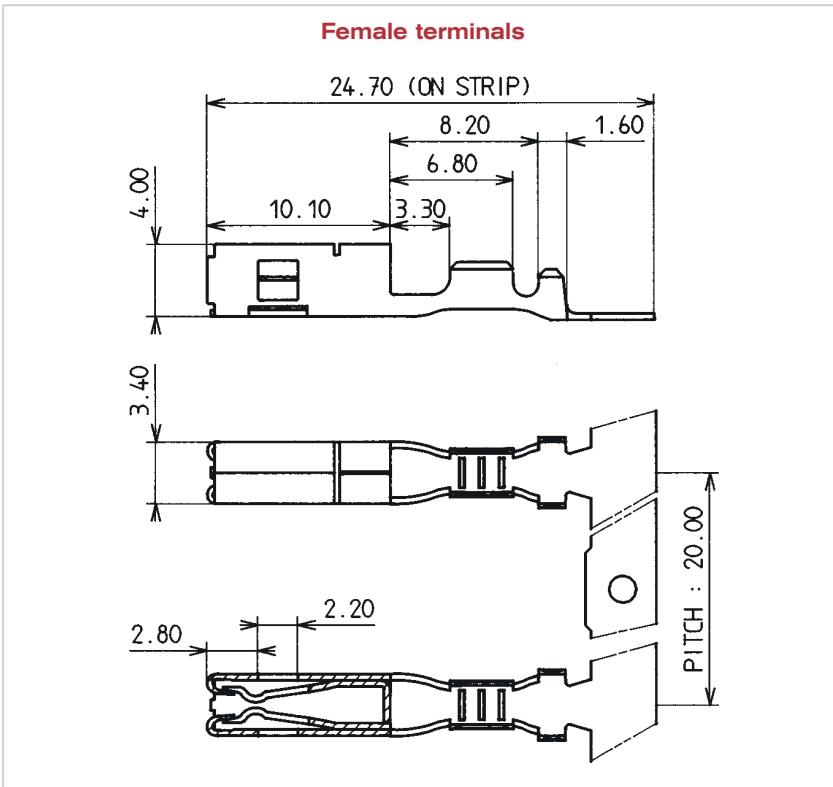

# Mouser Electronics

Authorized Distributor

Click to View Pricing, Inventory, Delivery & Lifecycle Information:

[Aptiv:](#)

[211CC3S3120](#)