

# Metallized Polyester Film Capacitors MKT Radial Epoxy Lacquered Type

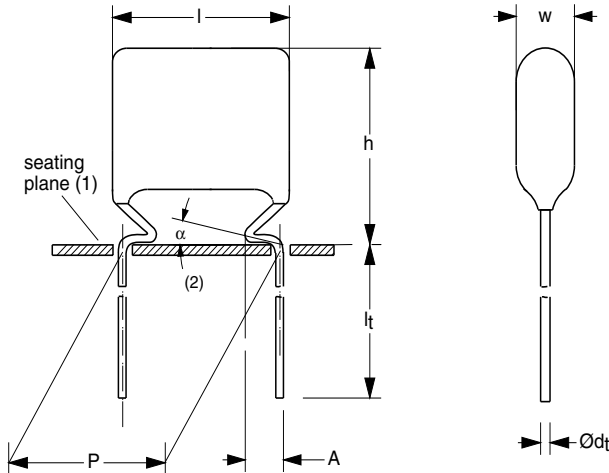

Dimensions in mm

- (1) Hole  $\varnothing$  1.0 for  $d_t = 0.6$  mm  
Hole  $\varnothing$  1.3 for  $d_t = 0.8$  mm
- (2)  $0 \leq \alpha < 50^\circ$
- (3)  $A = 2.0 + 1.0/-0.5$  mm (pitch = 10.0 mm)  
 $A = 2.5 + 1.4/-0.5$  mm (pitch = 15.0 mm, 22.5 mm and 27.5 mm)

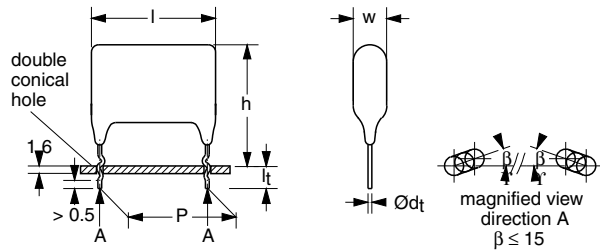

Dimensions in mm

## APPLICATIONS

Blocking and coupling. Bypass and energy reservoir

## MARKING

C-value; tolerance; rated voltage

## DIELECTRIC

Polyester film

## ELECTRODES

Vacuum deposited aluminium

## FEATURES

Available taped on reel and loose in box

- Material categorization:  
for definitions of compliance please see  
[www.vishay.com/doc?99912](http://www.vishay.com/doc?99912)



RoHS  
COMPLIANT

## COATING

Flame retardant epoxy material (UL-class 94 V-0)

## CONSTRUCTION

Wound mono construction

## LEADS

Tinned wire

## CAPACITANCE RANGE (E12 SERIES)

0.001 to 1.0  $\mu$ F

## CAPACITANCE TOLERANCE

$\pm 10\%$ ;  $\pm 5\%$

## RATED (DC) VOLTAGE

63 V; 100 V; 250 V; 400 V; 630 V

## RATED (AC) VOLTAGE

40 V; 63 V; 160 V; 220 V; 250 V

## CLIMATIC CATEGORY

55/105/56

## RATED TEMPERATURE

85 °C

## MAXIMUM APPLICATION TEMPERATURE

105 °C

## REFERENCE SPECIFICATIONS

IEC 60384-2

## PERFORMANCE GRADE

Grade 1 (long life)

## DETAIL SPECIFICATION

For more detailed data and test requirements see "Type detail specification HQN-384-02/101"

**COMPOSITION OF CATALOG NUMBER**

| TYPE AND PITCHES |         |
|------------------|---------|
| 368              | 10.0 mm |
|                  | 15.0 mm |
|                  | 22.5 mm |
|                  | 27.5 mm |

**CAPACITANCE**  
(numerically)

| MULTIPLIER<br>(nF) |   |
|--------------------|---|
| 0.1                | 2 |
| 1                  | 3 |
| 10                 | 4 |
| 100                | 5 |

Example:  
104 = 10 x 10 = 100 nF

|       |     |    |    |   |
|-------|-----|----|----|---|
| 2222  | 368 | XX | XX | X |
| BFC2* | 368 | XX | XX | X |

\* Use this partnumber for those with access to the Vishay's SAP system and Partners web-site within the Americas

| TYPE | PACKAGING     | LEAD CONFIGURATION  | ON REQUEST |      |       |       |       |       |
|------|---------------|---|------------|------|-------|-------|-------|-------|
|      |               |   | C-TOL      | 63 V | 100 V | 250 V | 400 V | 630 V |
| 368  | loose in box  | lead length 4.0 + 1.0/- 0.5 mm  | ± 10 %     | 15   | 25    | 45    | 55    | 65    |
|      |               |   | ± 5 %      | 16   | 26    | 46    | 56    | 66    |
|      |               | lead length 4.0 + 1.0/- 0.5 mm (lock lead)  | ± 10 %     | -    | 90    | 90    | 90    | 90    |
|      |               | dimensions of this code numbers stays between brackets  |            |      |       |       |       |       |
|      |               | lead length 3.5 ± 0.5 mm  | ± 10 %     | 13   | 23    | 43    | 53    | 63    |
|      |               |   | ± 5 %      | 17   | 27    | 47    | 57    | 67    |
|      |               | long leads:<br>19.0 ± 4.0 mm for lead pitch = 15.0 mm<br>25.0 ± 4.0 mm for lead pitch = 22.5 mm<br>24.0 ± 4.0 mm for lead pitch = 27.5 mm | ± 10 %     | 11   | 21    | 41    | 51    | 61    |
|      |               |   | ± 5 %      | 12   | 22    | 42    | 52    | 62    |
|      | taped on reel | H = 16.0 mm; P <sub>0</sub> = 12.7 mm;<br>reel diameter = 500 mm  | ± 10 %     | 18   | 28    | 48    | 58    | 68    |
|      |               |   | ± 5 %      | 19   | 29    | 49    | 59    | 69    |

**SPECIFIC REFERENCE DATA**

| DESCRIPTION   | VALUE                   |                          |                          |                 |                     |
|---|-------------------------|--------------------------|--------------------------|-----------------|---------------------|
|   | at 1 kHz                | at 10 kHz                | at 100 kHz               |                 |                     |
| Tangent of loss angle:  |                         |                          |                          |                 |                     |
| C ≤ 0.1 μF  | ≤ 75 x 10 <sup>-4</sup> | ≤ 130 x 10 <sup>-4</sup> | ≤ 225 x 10 <sup>-4</sup> |                 |                     |
| 0.1 μF < C ≤ 0.47 μF  | ≤ 75 x 10 <sup>-4</sup> | ≤ 130 x 10 <sup>-4</sup> | ≤ 300 x 10 <sup>-4</sup> |                 |                     |
| 0.47 μF < C ≤ 1.0 μF  | ≤ 75 x 10 <sup>-4</sup> | ≤ 130 x 10 <sup>-4</sup> | -                        |                 |                     |
| Rated voltage pulse slope (dU/dt) <sub>R</sub>                          | at 63 V (DC)            | at 100 V (DC)            | at 250 V (DC)            | at 400 V (DC)   | at 630 V (DC)       |
| P = 10 mm   | 30 V/μs                 | 30 V/μs                  | 70 V/μs                  | 110 V/μs        | 70 V/μs             |
| P = 15 mm   |                         | 20 V/μs                  | 28 V/μs                  | 44 V/μs         | 70 V/μs             |
| P = 22.5 mm   |                         | 8 V/μs                   | 12 V/μs                  | 20 V/μs         | 28 V/μs             |
| P = 27.5 mm   |                         | 7 V/μs                   | 10 V/μs                  | 16 V/μs         | 24 V/μs             |
| R between leads, for C ≤ 0.33 μF:                                       |                         |                          |                          |                 |                     |
| at 10 V; 1 minute   | > 15000 MΩ              |                          |                          |                 |                     |
| at 100 V; 1 minute  |                         | > 15000 MΩ               | > 30000 MΩ               | > 30000 MΩ      |                     |
| at 500 V; 1 minute  |                         |                          |                          |                 | > 30000 MΩ          |
| RC between leads, for C > 0.33 μF:                                      |                         |                          |                          |                 |                     |
| at 10 V; 1 minute   | > 5000 s                |                          |                          |                 |                     |
| at 100 V; 1 minute  |                         | > 5000 s                 | > 10000 s                | > 10000 s       |                     |
| at 500 V; 1 minute  |                         |                          |                          |                 | > 10000 s           |
| R between interconnecting leads and casing;                             |                         |                          |                          |                 |                     |
| at 10 V; 1 minute   | > 30000 MΩ              |                          |                          |                 |                     |
| at 100 V; 1 minute  |                         | > 30000 MΩ               | > 30000 MΩ               | > 30000 MΩ      |                     |
| at 500 V; 1 minute  |                         |                          |                          |                 | > 30000 MΩ          |
| Withstanding (DC) voltage (cut off current 10 mA);<br>rise time 100 V/s | 100 V; 1 minute         | 160 V; 1 minute          | 400 V; 1 minute          | 640 V; 1 minute | 1008 V;<br>1 minute |
| Withstanding (DC) voltage between leads and case                        | 200 V; 1 minute         | 200 V; 1 minute          | 500 V; 1 minute          | 800 V; 1 minute | 1260 V;<br>1 minute |



$U_{Rdc} = 63\text{ V}$ ;  $U_{Rac} = 40\text{ V}$

| C<br>( $\mu\text{F}$ )   | DIMENSIONS<br>$w_{\text{max}} \times h_{\text{max}} \times l_{\text{max}}$<br>(mm) | MASS<br>(g) | CATALOG NUMBER 2222 368 ..... AND PACKAGING |             |                  |      |                                  |      |
|--|--|-------------|---|-------------|------------------|------|----------------------------------|------|
|  |  |             | LOOSE IN BOX                                |             |                  | REEL | LOOSE IN BOX                     |      |
|  |  |             | $l_t = 4.0 + 1.0/-0.5\text{ mm}$            | short leads | long leads       | SPQ  | $l_t = 4.0 + 1.0/-0.5\text{ mm}$ | SPQ  |
|  |  |             | C-tol = $\pm 10\%$                          | SPQ         | SPQ              |      | C-tol = $\pm 10\%$               |      |
| last 5 digits of catalog number  | last 5 digits of catalog number  |             |   |             |                  |      |                                  |      |
| <b>Pitch = <math>10.0 \pm 0.4\text{ mm}</math>; <math>d_t = 0.60 \pm 0.06\text{ mm}</math></b> |  |             |   |             | <b>lock lead</b> |      |                                  |      |
| 0.22   | 4.2 x 13.2 (15.5) x 12.5   | 0.5         | 15224                                       | 2000        | 1000             | 1300 | 90316                            | 1100 |
| 0.27   | 4.0 x 12.8 (15.5) x 12.5   | 0.5         | 15274                                       | 2000        | 1000             | 1300 | 90317                            | 1100 |
| 0.33   | 4.3 x 13.1 (15.5) x 12.5   | 0.5         | 15334                                       | 2000        | 1000             | 1300 | 90318                            | 1100 |
| 0.39   | 4.2 x 12.9 (15.5) x 12.5   | 0.5         | 15394                                       | 2000        | 1000             | 1300 | 90319                            | 1100 |
| 0.47   | 4.3 x 13.4 (16.0) x 12.5   | 0.5         | 15474                                       | 2000        | 1000             | 1200 | 90321                            | 1000 |
| 0.56   | 4.7 x 13.7 (16.0) x 12.5   | 0.5         | 15564                                       | 2000        | 1000             | 1200 | 90322                            | 1000 |
| 0.68   | 5.1 x 14.1 (16.5) x 12.5   | 0.6         | 15684                                       | 2000        | 1000             | 1100 | 90323                            | 1500 |
| 0.82   | 5.5 x 14.5 (17.0) x 12.5   | 0.6         | 15824                                       | 2000        | 1000             | 1000 | 90324                            | 1250 |
| 1.0  | 6.0 x 15.0 (17.5) x 12.5   | 0.8         | 15105                                       | 2000        | 1000             | 900  | 90325                            | 1250 |

$U_{Rdc} = 100\text{ V}$ ;  $U_{Rac} = 63\text{ V}$

| C<br>( $\mu\text{F}$ )   | DIMENSIONS<br>$w_{\text{max}} \times h_{\text{max}} \times l_{\text{max}}$<br>(mm) | MASS<br>(g) | CATALOG NUMBER 2222 368 ..... AND PACKAGING |             |                  |      |                                  |      |
|--|--|-------------|---|-------------|------------------|------|----------------------------------|------|
|  |  |             | LOOSE IN BOX                                |             |                  | REEL | LOOSE IN BOX                     |      |
|  |  |             | $l_t = 4.0 + 1.0/-0.5\text{ mm}$            | short leads | long leads       | SPQ  | $l_t = 4.0 + 1.0/-0.5\text{ mm}$ | SPQ  |
|  |  |             | C-tol = $\pm 10\%$                          | SPQ         | SPQ              |      | C-tol = $\pm 10\%$               |      |
| last 5 digits of catalog number  | last 5 digits of catalog number  |             |   |             |                  |      |                                  |      |
| <b>Pitch = <math>10.0 \pm 0.4\text{ mm}</math>; <math>d_t = 0.60 \pm 0.06\text{ mm}</math></b> |  |             |   |             | <b>lock lead</b> |      |                                  |      |
| 0.056  | 4.0 x 13.0 (15.0) x 12.5   | 0.4         | 25563                                       | 2000        | 1000             | 1500 | 90205                            | 1250 |
| 0.068  |  |             | 25683                                       |             |                  |      | 90206                            |      |
| 0.082  | 3.7 x 12.7 (15.0) x 12.5   | 0.4         | 25823                                       | 2000        | 1000             | 1500 | 90207                            | 1250 |
| 0.10   | 4.0 x 13.0 (15.0) x 12.5   | 0.4         | 25104                                       | 2000        | 1000             | 1500 | 90208                            | 1250 |
| 0.12   | 4.3 x 13.3 (15.0) x 12.5   | 0.4         | 25124                                       | 2000        | 1000             | 1500 | 90209                            | 1250 |
| 0.15   | 3.9 x 12.9 (15.0) x 12.5   | 0.4         | 25154                                       | 2000        | 1000             | 1500 | 90211                            | 1250 |
| 0.18   | 4.2 x 13.2 (15.5) x 12.5   | 0.5         | 25184                                       | 2000        | 1000             | 1300 | 90212                            | 1100 |
| 0.22   | 4.5 x 13.6 (16.0) x 12.5   | 0.5         | 25224                                       | 2000        | 1000             | 1200 | 90213                            | 1000 |
| <b>Pitch = <math>15.0 \pm 0.4\text{ mm}</math>; <math>d_t = 0.80 \pm 0.08\text{ mm}</math></b> |  |             |   |             | <b>lock lead</b> |      |                                  |      |
| 0.27   | 5.0 x 14.0 (17.0) x 17.5   | 0.6         | 25274                                       | 2000        | 1000             | 1200 | 90214                            | 1750 |
| 0.33   |  |             | 25334                                       |             |                  |      | 90215                            |      |
| 0.39   |  |             | 25394                                       |             |                  |      | 90216                            |      |
| 0.47   | 5.5 x 14.5 (17.5) x 17.5   | 0.7         | 25474                                       | 2000        | 1000             | 1100 | 90217                            | 1500 |
| 0.56   |  |             | 25564                                       |             |                  |      | 90218                            |      |
| 0.68   | 6.0 x 15.0 (18.0) x 17.5   | 0.9         | 25684                                       | 2000        | 1000             | 1000 | 90219                            | 1500 |
| 0.82   | 6.5 x 15.5 (18.5) x 17.5   | 1.0         | 25824                                       | 1000        | 1000             | 900  | 90221                            | 1250 |
| 1.0  | 7.5 x 16.5 (19.5) x 17.5   | 1.3         | 25105                                       | 1000        | 1000             | 800  | 90222                            | 1000 |



| C<br>( $\mu$ F)  | DIMENSIONS<br>$w_{max} \times h_{max} \times l_{max}$<br>(mm) | MASS<br>(g) | CATALOG NUMBER 2222 368 ..... AND PACKAGING |             |            |      |                              |      |
|--|---|-------------|---|-------------|------------|------|------------------------------|------|
|  |   |             | LOOSE IN BOX                                |             |            | REEL | LOOSE IN BOX                 |      |
|  |   |             | $l_t =$<br>4.0 + 1.0/- 0.5 mm               | short leads | long leads | SPQ  | $l_t =$<br>4.0 + 1.0/-0.5 mm | SPQ  |
|  |   |             | C-tol = $\pm$ 10 %                          | SPQ         | SPQ        |      | C-tol = $\pm$ 10 %           |      |
| last 5 digits of<br>catalog number   | last 5 digits of<br>catalog number                            |             |   |             |            |      |                              |      |
| <b>Pitch = 22.5 <math>\pm</math> 0.4 mm; <math>d_t = 0.80 \pm 0.08</math> mm</b> |   |             |   |             |            |      | <b>lock lead</b>             |      |
| 1.2  | 6.0 x 18.0 (21.0) x 26.0                                      | 2.5         | 25125                                       | 1000        | 1000       |      | 90223                        | 1000 |
| 1.5  |   |             | 25155                                       |             |            |      | 90224                        |      |
| 1.8  | 7.0 x 19.0 (22.0) x 26.0                                      | 3.2         | 25185                                       | 1000        | 1000       |      | 90225                        | 900  |
| 2.2  | 7.5 x 19.5 (23.0) x 26.0                                      | 3.5         | 25225                                       | 1000        | 500        |      | 90226                        | 750  |
| 2.7  | 8.5 x 21.5 (24.0) x 26.0                                      | 4.1         | 25275                                       | 1000        | 500        |      | 90227                        | 600  |
| 3.3  | 9.0 x 22.0 (24.5) x 26.0                                      | 4.5         | 25335                                       | 1000        | 500        |      | 90228                        | 600  |
| <b>Pitch = 27.5 <math>\pm</math> 0.4 mm; <math>d_t = 0.80 \pm 0.08</math> mm</b> |   |             |   |             |            |      | <b>lock lead</b>             |      |
| 3.9  | 9.0 x 22.0 (24.0) x 30.0                                      | 4.8         | 25395                                       | 500         | 500        |      | 90229                        | 500  |
| 4.7  | 10.0 x 23.0 (25.0) x 30.0                                     | 5.5         | 25475                                       | 500         | 500        |      | 90178                        | 400  |
| 5.6  | 11.0 x 24.0 (26.0) x 30.0                                     | 6.2         | 25565                                       | 500         | 250        |      | 90231                        | 350  |
| 6.8  | 12.0 x 25.0 (27.0) x 30.0                                     | 6.8         | 25685                                       | 500         | 250        |      | 90232                        | 350  |

$U_{Rdc} = 250$  V;  $U_{Rac} = 160$  V

| C<br>( $\mu$ F)  | DIMENSIONS<br>$w_{max} \times h_{max} \times l_{max}$<br>(mm) | MASS<br>(g) | CATALOG NUMBER 2222 368 ..... AND PACKAGING |             |            |      |                              |      |
|--|---|-------------|---|-------------|------------|------|------------------------------|------|
|  |   |             | LOOSE IN BOX                                |             |            | REEL | LOOSE IN BOX                 |      |
|  |   |             | $l_t =$<br>4.0 + 1.0/- 0.5 mm               | short leads | long leads | SPQ  | $l_t =$<br>4.0 + 1.0/-0.5 mm | SPQ  |
|  |   |             | C-tol = $\pm$ 10 %                          | SPQ         | SPQ        |      | C-tol = $\pm$ 10 %           |      |
| last 5 digits of<br>catalog number   | last 5 digits of<br>catalog number                            |             |   |             |            |      |                              |      |
| <b>Pitch = 10.0 <math>\pm</math> 0.4 mm; <math>d_t = 0.60 \pm 0.06</math> mm</b> |   |             |   |             |            |      | <b>lock lead</b>             |      |
| 0.027  | 4.2 x 13.0 (15.0) x 12.5                                      | 0.4         | 45273                                       | 2000        | 1000       | 1500 | 90233                        | 1250 |
| 0.033  | 4.6 x 13.0 (15.0) x 12.5                                      | 0.5         | 45333                                       | 2000        | 1000       | 1300 | 90234                        | 1250 |
| 0.039  | 4.0 x 13.0 (15.0) x 12.5                                      | 0.4         | 45393                                       | 2000        | 1000       | 1500 | 90235                        | 1250 |
| 0.047  | 4.5 x 13.5 (15.5) x 12.5                                      | 0.5         | 45473                                       | 2000        | 1000       | 1500 | 90176                        | 1250 |
| 0.056  | 4.6 x 13.5 (15.5) x 12.5                                      | 0.5         | 45563                                       | 2000        | 1000       | 1300 | 90236                        | 1100 |
| 0.068  |   |             | 45683                                       |             |            |      | 90237                        |      |
| 0.082  | 4.4 x 13.4 (16.0) x 12.5                                      | 0.5         | 45823                                       | 2000        | 1000       | 1200 | 90238                        | 1000 |
| 0.10   | 4.7 x 13.7 (16.0) x 12.5                                      | 0.5         | 45104                                       | 2000        | 1000       | 1200 | 90177                        | 1000 |
| <b>Pitch = 15.0 <math>\pm</math> 0.4 mm; <math>d_t = 0.80 \pm 0.08</math> mm</b> |   |             |   |             |            |      | <b>lock lead</b>             |      |
| 0.12   | 5.0 x 14.0 (17.0) x 17.5                                      | 0.6         | 45124                                       | 2000        | 1000       | 1200 | 90239                        | 1750 |
| 0.15   |   |             | 45154                                       |             |            |      | 90241                        |      |
| 0.18   | 5.5 x 14.5 (17.5) x 17.5                                      | 0.7         | 45184                                       | 2000        | 1000       | 1100 | 90242                        | 1500 |
| 0.22   | 6.0 x 15.0 (18.0) x 17.5                                      | 0.9         | 45224                                       | 2000        | 1000       | 1000 | 90243                        | 1500 |
| 0.27   | 6.0 x 15.5 (18.5) x 17.5                                      | 1.0         | 45274                                       | 2000        | 1000       | 900  | 90244                        | 1250 |
| 0.33   | 6.8 x 16.0 (19.0) x 17.5                                      | 1.2         | 45334                                       | 1000        | 1000       | 800  | 90245                        | 1250 |
| <b>Pitch = 22.5 <math>\pm</math> 0.4 mm; <math>d_t = 0.80 \pm 0.08</math> mm</b> |   |             |   |             |            |      | <b>lock lead</b>             |      |
| 0.39   | 5.0 x 17.0 (20.0) x 26.0                                      | 1.8         | 45394                                       | 1000        | 1000       |      | 90246                        | 1250 |
| 0.47   | 5.5 x 17.5 (20.5) x 26.0                                      | 2.2         | 45474                                       | 1000        | 1000       |      | 90247                        | 1250 |
| 0.56   | 6.0 x 18.0 (21.0) x 26.0                                      | 2.5         | 45564                                       | 1000        | 1000       |      | 90248                        | 1000 |
| 0.68   | 6.6 x 18.5 (21.5) x 26.0                                      | 2.8         | 45684                                       | 1000        | 1000       |      | 90249                        | 1000 |
| 0.82   | 7.2 x 19.0 (22.0) x 26.0                                      | 3.2         | 45824                                       | 1000        | 1000       |      | 90251                        | 900  |
| 1.0  | 8.0 x 20.0 (23.0) x 26.0                                      | 3.8         | 45105                                       | 1000        | 500        |      | 90252                        | 750  |



| C<br>( $\mu$ F)                                     | DIMENSIONS<br>$w_{max} \times h_{max} \times l_{max}$<br>(mm) | MASS<br>(g) | CATALOG NUMBER 2222 368 ..... AND PACKAGING |             |            |      |                              |     |
|---|---|-------------|---|-------------|------------|------|------------------------------|-----|
|   |   |             | LOOSE IN BOX                                |             |            | REEL | LOOSE IN BOX                 |     |
|   |   |             | $l_t =$<br>4.0 + 1.0/- 0.5 mm               | short leads | long leads | SPQ  | $l_t =$<br>4.0 + 1.0/-0.5 mm | SPQ |
|   |   |             | C-tol = $\pm$ 10 %                          | SPQ         | SPQ        |      | C-tol = $\pm$ 10 %           |     |
| last 5 digits of<br>catalog number                  | last 5 digits of<br>catalog number                            |             |   |             |            |      |                              |     |
| Pitch = 27.5 $\pm$ 0.4 mm; $d_t = 0.80 \pm 0.08$ mm |   |             |   |             |            |      | lock lead                    |     |
| 1.2   | 8.0 x 21.0 (23.0) x 30.0                                      | 4.1         | 45125                                       | 500         | 500        |      | 90253                        | 600 |
| 1.5   | 9.0 x 22.0 (25.0) x 30.0                                      | 4.8         | 45155                                       | 500         | 500        |      | 90254                        | 450 |
| 1.8   | 10.0 x 23.0 (26.0) x 30.0                                     | 5.5         | 45185                                       | 500         | 500        |      | 90255                        | 400 |
| 2.2   | 11.0 x 24.0 (27.0) x 30.0                                     | 6.2         | 45225                                       | 500         | 250        |      | 90256                        | 350 |

$U_{Rdc} = 400$  V;  $U_{Rac} = 220$  V

| C<br>( $\mu$ F)                                     | DIMENSIONS<br>$w_{max} \times h_{max} \times l_{max}$<br>(mm) | MASS<br>(g) | CATALOG NUMBER 2222 368 ..... AND PACKAGING |             |            |      |                              |      |
|---|---|-------------|---|-------------|------------|------|------------------------------|------|
|   |   |             | LOOSE IN BOX                                |             |            | REEL | LOOSE IN BOX                 |      |
|   |   |             | $l_t =$<br>4.0 + 1.0/- 0.5 mm               | short leads | long leads | SPQ  | $l_t =$<br>4.0 + 1.0/-0.5 mm | SPQ  |
|   |   |             | C-tol = $\pm$ 10 %                          | SPQ         | SPQ        |      | C-tol = $\pm$ 10 %           |      |
| last 5 digits of<br>catalog number                  | last 5 digits of<br>catalog number                            |             |   |             |            |      |                              |      |
| Pitch = 10.0 $\pm$ 0.4 mm; $d_t = 0.60 \pm 0.06$ mm |   |             |   |             |            |      | lock lead                    |      |
| 0.0010  | 4.5 x 13.5 (15.5) x 12.5                                      | 0.5         | 55102                                       | 2000        | 1000       | 1500 | 90257                        | 1100 |
| 0.0012  |   |             | 55122                                       |             |            |      | 90258                        |      |
| 0.0015  |   |             | 55152                                       |             |            |      | 90259                        |      |
| 0.0018  |   |             | 55182                                       |             |            |      | 90261                        |      |
| 0.0022  | 4.0 x 13.0 (15.5) x 12.5                                      | 0.5         | 55222                                       | 2000        | 1000       | 1500 | 90262                        | 1100 |
| 0.0027  | 4.3 x 13.3 (15.5) x 12.5                                      | 0.5         | 55272                                       | 2000        | 1000       | 1500 | 90263                        | 1100 |
| 0.0033  | 4.6 x 13.6 (15.5) x 12.5                                      | 0.5         | 55332                                       | 2000        | 1000       | 1500 | 90264                        | 1100 |
| 0.0039  | 4.0 x 13.0 (15.5) x 12.5                                      | 0.5         | 55392                                       | 2000        | 1000       | 1500 | 90265                        | 1100 |
| 0.0047  | 4.1 x 13.2 (15.5) x 12.5                                      | 0.5         | 55472                                       | 2000        | 1000       | 1500 | 90266                        | 1100 |
| 0.0056  | 4.6 x 13.6 (15.5) x 12.5                                      | 0.5         | 55562                                       | 2000        | 1000       | 1500 | 90267                        | 1100 |
| 0.0068  |   |             | 55682                                       |             |            |      | 90268                        |      |
| 0.0082  |   |             | 55822                                       |             |            |      | 90269                        |      |
| 0.010   |   |             | 55103                                       |             |            |      | 90271                        |      |
| 0.012   | 4.0 x 13.0 (15.5) x 12.5                                      | 0.5         | 55123                                       | 2000        | 1000       | 1500 | 90272                        | 1100 |
| 0.015   | 4.1 x 13.0 (15.5) x 12.5                                      | 0.5         | 55153                                       | 2000        | 1000       | 1300 | 90273                        | 1100 |
| 0.018   | 4.4 x 13.0 (15.5) x 12.5                                      | 0.5         | 55183                                       | 2000        | 1000       | 1500 | 90274                        | 1100 |
| 0.022   | 4.2 x 12.9 (15.5) x 12.5                                      | 0.5         | 55223                                       | 2000        | 1000       | 1500 | 90175                        | 1100 |
| 0.027   | 4.2 x 13.2 (15.5) x 12.5                                      | 0.5         | 55273                                       | 2000        | 1000       | 1300 | 90275                        | 1100 |
| 0.033   | 4.6 x 13.7 (15.5) x 12.5                                      | 0.5         | 55333                                       | 2000        | 1000       | 1300 | 90188                        | 1100 |
| Pitch = 15.0 $\pm$ 0.4 mm; $d_t = 0.80 \pm 0.08$ mm |   |             |   |             |            |      | lock lead                    |      |
| 0.039   | 5.0 x 13.9 (16.5) x 17.5                                      | 0.6         | 55393                                       | 2000        | 1000       | 1200 | 90276                        | 2000 |
| 0.047   | 5.4 x 14.5 (17.0) x 17.5                                      | 0.7         | 55473                                       | 2000        | 1000       | 1200 | 90277                        | 1750 |
| 0.056   | 5.0 x 13.7 (16.5) x 17.5                                      | 0.6         | 55563                                       | 2000        | 1000       | 1200 | 90278                        | 2000 |
| 0.068   | 5.0 x 13.5 (16.5) x 17.5                                      | 0.6         | 55683                                       | 2000        | 1000       | 1200 | 90279                        | 2000 |
| 0.082   | 4.8 x 14.0 (16.5) x 17.5                                      | 0.6         | 55823                                       | 2000        | 1000       | 1100 | 90281                        | 2000 |
| 0.10  | 5.3 x 14.5 (17.5) x 17.5                                      | 0.7         | 55104                                       | 2000        | 1000       | 1000 | 90186                        | 1500 |
| 0.12  | 5.7 x 15.0 (18.0) x 17.5                                      | 0.9         | 55124                                       | 1000        | 1000       | 900  | 90282                        | 1500 |
| 0.15  | 6.4 x 15.5 (18.5) x 17.5                                      | 1.0         | 55154                                       | 1000        | 1000       | 800  | 90187                        | 1250 |



| C<br>( $\mu$ F)  | DIMENSIONS<br>$w_{max} \times h_{max} \times l_{max}$<br>(mm) | MASS<br>(g) | CATALOG NUMBER 2222 368 ..... AND PACKAGING |             |            |      |                              |      |
|--|---|-------------|---|-------------|------------|------|------------------------------|------|
|  |   |             | LOOSE IN BOX                                |             |            | REEL | LOOSE IN BOX                 |      |
|  |   |             | $l_t =$<br>4.0 + 1.0/- 0.5 mm               | short leads | long leads | SPQ  | $l_t =$<br>4.0 + 1.0/-0.5 mm | SPQ  |
|  |   |             | C-tol = $\pm$ 10 %                          | SPQ         | SPQ        |      | C-tol = $\pm$ 10 %           |      |
| last 5 digits of<br>catalog number   | last 5 digits of<br>catalog number                            |             |   |             |            |      |                              |      |
| <b>Pitch = 22.5 <math>\pm</math> 0.4 mm; <math>d_t = 0.80 \pm 0.08</math> mm</b> |   |             |   |             |            |      | <b>lock lead</b>             |      |
| 0.18   | 5.6 x 17.5 (20.5) x 26.0                                      | 2.2         | 55184                                       | 1000        | 1000       |      | 90283                        | 1250 |
| 0.22   | 6.3 x 18.5 (21.5) x 26.0                                      | 2.8         | 55224                                       | 1000        | 1000       |      | 90284                        | 1000 |
| 0.27   | 6.0 x 18.0 (21.0) x 26.0                                      | 2.5         | 55274                                       | 1000        | 1000       |      | 90285                        | 1000 |
| 0.33   | 6.4 x 18.5 (21.5) x 26.0                                      | 2.8         | 55334                                       | 1000        | 1000       |      | 90286                        | 1000 |
| 0.39   | 7.1 x 19.0 (21.5) x 26.0                                      | 2.8         | 55394                                       | 1000        | 1000       |      | 90287                        | 900  |
| 0.47   | 8.0 x 20.0 (22.5) x 26.0                                      | 3.8         | 55474                                       | 1000        | 500        |      | 90179                        | 750  |
| <b>Pitch = 27.5 <math>\pm</math> 0.4 mm; <math>d_t = 0.80 \pm 0.08</math> mm</b> |   |             |   |             |            |      | <b>lock lead</b>             |      |
| 0.56   | 7.5 x 20.5 (22.5) x 30.0                                      | 3.8         | 55564                                       | 500         | 500        |      | 90288                        | 600  |
| 0.68   | 8.5 x 21.5 (23.5) x 30.0                                      | 4.5         | 55684                                       | 500         | 500        |      | 90289                        | 500  |
| 0.82   | 9.5 x 22.5 (24.5) x 30.0                                      | 5.2         | 55824                                       | 500         | 500        |      | 90291                        | 450  |
| 1.0  | 10.5 x 23.5 (26.5) x 30.0                                     | 5.8         | 55105                                       | 500         | 250        |      | 90292                        | 350  |

$U_{Rdc} = 630$  V;  $U_{Rac} = 250$  V

| C<br>( $\mu$ F)  | DIMENSIONS<br>$w_{max} \times h_{max} \times l_{max}$<br>(mm) | MASS<br>(g) | CATALOG NUMBER 2222 368 ..... AND PACKAGING |             |            |      |                              |      |
|--|---|-------------|---|-------------|------------|------|------------------------------|------|
|  |   |             | LOOSE IN BOX                                |             |            | REEL | LOOSE IN BOX                 |      |
|  |   |             | $l_t =$<br>4.0 + 1.0/- 0.5 mm               | short leads | long leads | SPQ  | $l_t =$<br>4.0 + 1.0/-0.5 mm | SPQ  |
|  |   |             | C-tol = $\pm$ 10 %                          | SPQ         | SPQ        |      | C-tol = $\pm$ 10 %           |      |
| last 5 digits of<br>catalog number   | last 5 digits of<br>catalog number                            |             |   |             |            |      |                              |      |
| <b>Pitch = 10.0 <math>\pm</math> 0.4 mm; <math>d_t = 0.60 \pm 0.06</math> mm</b> |   |             |   |             |            |      | <b>lock lead</b>             |      |
| 0.010  | 4.3 x 13.1 (15.5) x 12.5                                      | 0.5         | 65103                                       | 2000        | 1000       | 1300 | 90293                        | 1100 |
| 0.012  | 4.6 x 13.4 (16.0) x 12.5                                      | 0.5         | 65123                                       | 2000        | 1000       | 1200 | 90294                        | 1000 |
| 0.015  | 4.9 x 13.9 (16.5) x 12.5                                      | 0.6         | 65153                                       | 2000        | 1000       | 1100 | 90295                        | 1500 |
| 0.018  | 5.3 x 14.3 (17.0) x 12.5                                      | 0.6         | 65183                                       | 2000        | 1000       | 1000 | 90296                        | 1250 |
| 0.022  | 5.9 x 14.9 (17.5) x 12.5                                      | 0.8         | 65223                                       | 2000        | 1000       | 900  | 90297                        | 1250 |
| <b>Pitch = 15.0 <math>\pm</math> 0.4 mm; <math>d_t = 0.80 \pm 0.08</math> mm</b> |   |             |   |             |            |      | <b>lock lead</b>             |      |
| 0.027  | 5.5 x 14.5 (17.5) x 17.5                                      | 0.7         | 65273                                       | 2000        | 1000       | 1100 | 90298                        | 1500 |
| 0.033  | 6.0 x 15.0 (18.0) x 17.5                                      | 0.9         | 65333                                       | 2000        | 1000       | 1000 | 90299                        | 1500 |
| 0.039  | 6.3 x 15.5 (18.5) x 17.5                                      | 1.0         | 65393                                       | 2000        | 1000       | 900  | 90301                        | 1250 |
| 0.047  | 7.0 x 16.0 (19.0) x 17.5                                      | 1.2         | 65473                                       | 2000        | 1000       | 800  | 90302                        | 1250 |
| 0.056  | 7.5 x 16.5 (19.5) x 17.5                                      | 1.3         | 65563                                       | 1000        | 1000       | 800  | 90303                        | 1000 |
| 0.068  | 8.0 x 17.0 (20.0) x 17.5                                      | 1.4         | 65683                                       | 1000        | 1000       | 750  | 90304                        | 1000 |
| <b>Pitch = 22.5 <math>\pm</math> 0.4 mm; <math>d_t = 0.80 \pm 0.08</math> mm</b> |   |             |   |             |            |      | <b>lock lead</b>             |      |
| 0.082  | 6.1 x 18.0 (21.0) x 26.0                                      | 2.5         | 65823                                       | 1000        | 1000       |      | 90305                        | 1000 |
| 0.10   | 7.0 x 19.0 (22.0) x 26.0                                      | 3.2         | 65104                                       | 1000        | 1000       |      | 90306                        | 900  |
| 0.12   | 7.2 x 19.5 (22.5) x 26.0                                      | 3.5         | 65124                                       | 1000        | 1000       |      | 90307                        | 750  |
| 0.15   | 8.0 x 21.0 (23.0) x 26.0                                      | 3.8         | 65154                                       | 1000        | 500        |      | 90308                        | 750  |
| 0.18   | 9.0 x 22.0 (24.0) x 26.0                                      | 4.5         | 65184                                       | 1000        | 500        |      | 90309                        | 600  |
| 0.22   | 10.0 x 23.0 (25.0) x 26.0                                     | 5.2         | 65224                                       | 1000        | 500        |      | 90311                        | 550  |



| C<br>( $\mu$ F)                                     | DIMENSIONS<br>$w_{max} \times h_{max} \times l_{max}$<br>(mm) | MASS<br>(g) | CATALOG NUMBER 2222 368 ..... AND PACKAGING |             |            |       |                              |     |
|---|---|-------------|---|-------------|------------|-------|------------------------------|-----|
|   |   |             | LOOSE IN BOX                                |             |            | REEL  | LOOSE IN BOX                 |     |
|   |   |             | $l_t =$<br>4.0 + 1.0/- 0.5 mm               | short leads | long leads | SPQ   | $l_t =$<br>4.0 + 1.0/-0.5 mm | SPQ |
|   |   |             | C-tol = $\pm 10$ %                          | SPQ         | SPQ        |       | C-tol = $\pm 10$ %           |     |
| last 5 digits of<br>catalog number                  | lock lead   |             | last 5 digits of<br>catalog number          |             |            |       |                              |     |
| Pitch = $27.5 \pm 0.4$ mm; $d_t = 0.80 \pm 0.08$ mm |   |             |   |             |            |       |                              |     |
| 0.27  | 10.0 x 23.0 (25.0) x 30.0                                     | 5.5         | 65274                                       | 500         | 500        | 90312 | 400                          |     |
| 0.33  | 11.5 x 24.5 (26.5) x 30.0                                     | 6.5         | 65334                                       | 500         | 250        | 90313 | 350                          |     |
| 0.39  | 12.5 x 25.5 (28.5) x 30.0                                     | 7.1         | 65394                                       | 500         | 250        | 90314 | 300                          |     |
| 0.47  | 14.0 x 27.0 (30.0) x 30.0                                     | 8.2         | 65474                                       | 250         | 250        | 90315 | 250                          |     |

**CAPACITANCE**

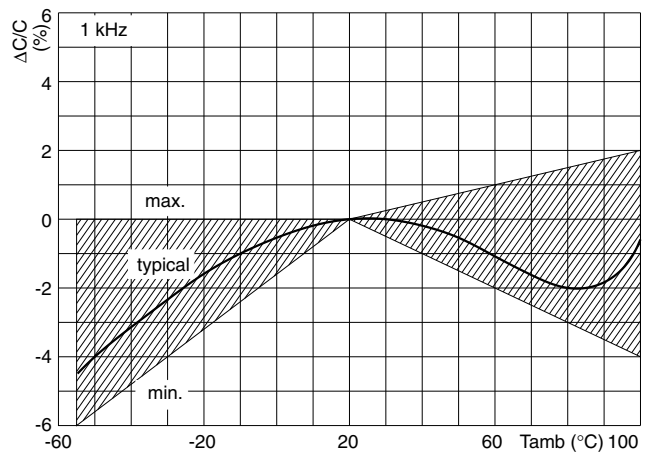
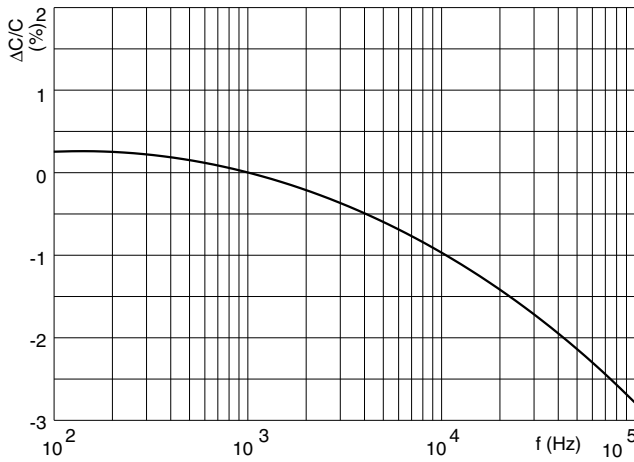

**IMPEDANCE**

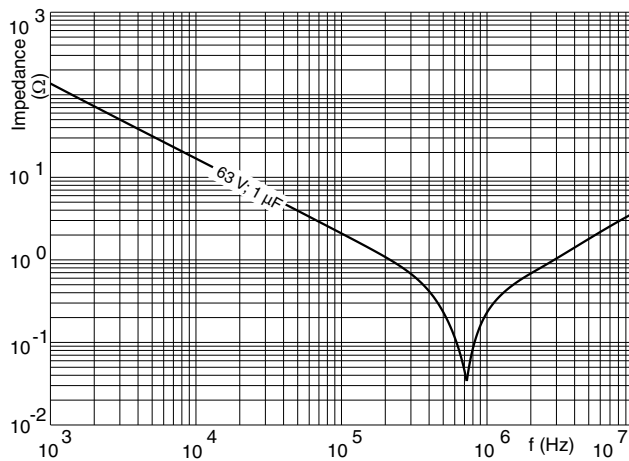



MAXIMUM RMS VOLTAGE (SINEWAVE) AS A FUNCTION OF FREQUENCY

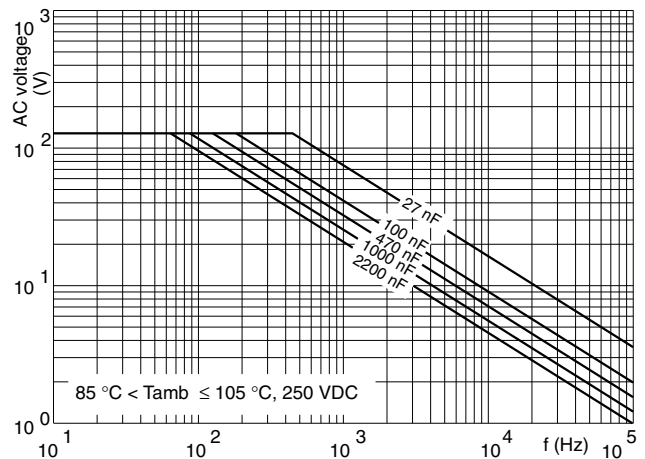
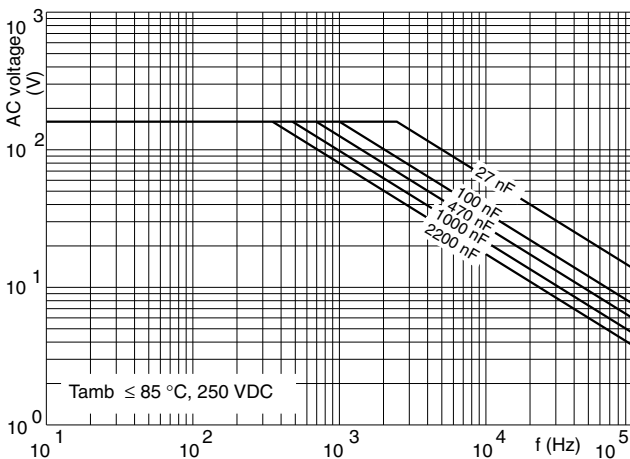
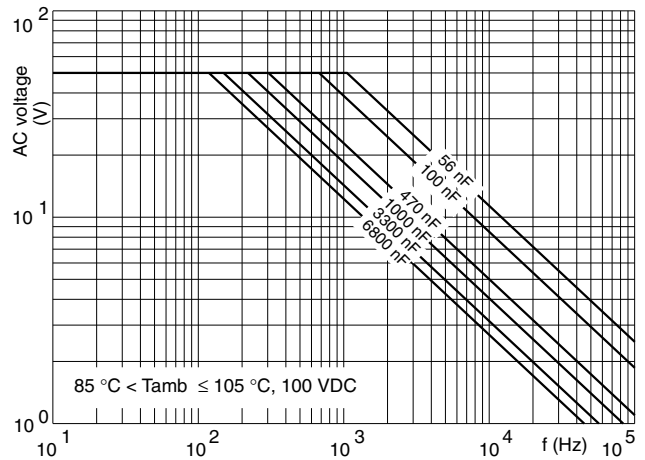
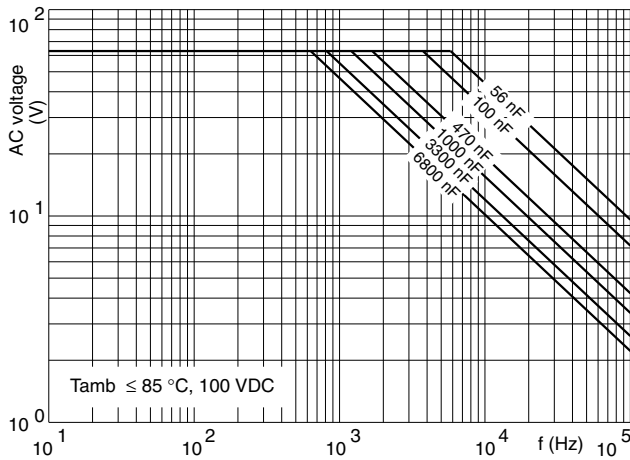
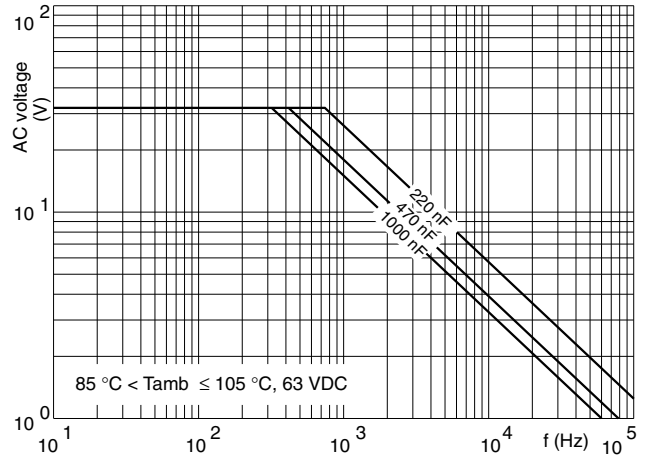
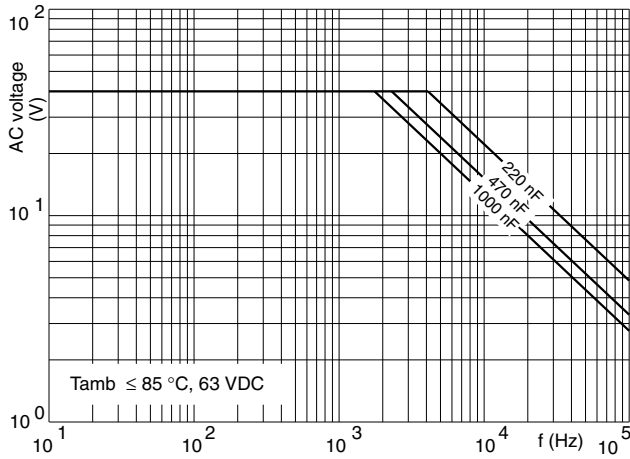



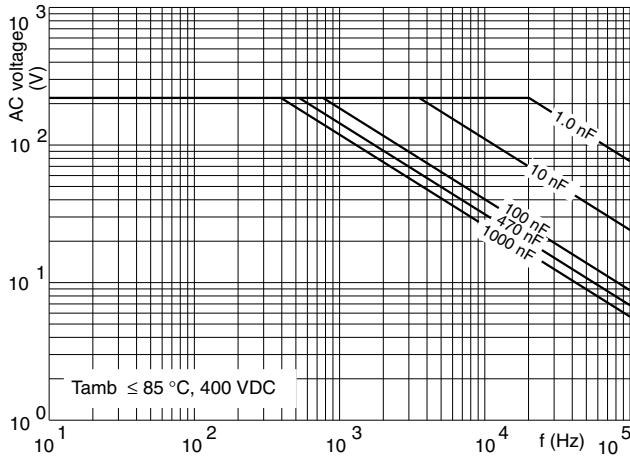



## **Disclaimer**

ALL PRODUCT, PRODUCT SPECIFICATIONS AND DATA ARE SUBJECT TO CHANGE WITHOUT NOTICE TO IMPROVE RELIABILITY, FUNCTION OR DESIGN OR OTHERWISE.

Vishay Intertechnology, Inc., its affiliates, agents, and employees, and all persons acting on its or their behalf (collectively, "Vishay"), disclaim any and all liability for any errors, inaccuracies or incompleteness contained in any datasheet or in any other disclosure relating to any product.

Vishay makes no warranty, representation or guarantee regarding the suitability of the products for any particular purpose or the continuing production of any product. To the maximum extent permitted by applicable law, Vishay disclaims (i) any and all liability arising out of the application or use of any product, (ii) any and all liability, including without limitation special, consequential or incidental damages, and (iii) any and all implied warranties, including warranties of fitness for particular purpose, non-infringement and merchantability.

Statements regarding the suitability of products for certain types of applications are based on Vishay's knowledge of typical requirements that are often placed on Vishay products in generic applications. Such statements are not binding statements about the suitability of products for a particular application. It is the customer's responsibility to validate that a particular product with the properties described in the product specification is suitable for use in a particular application. Parameters provided in datasheets and / or specifications may vary in different applications and performance may vary over time. All operating parameters, including typical parameters, must be validated for each customer application by the customer's technical experts. Product specifications do not expand or otherwise modify Vishay's terms and conditions of purchase, including but not limited to the warranty expressed therein.

Except as expressly indicated in writing, Vishay products are not designed for use in medical, life-saving, or life-sustaining applications or for any other application in which the failure of the Vishay product could result in personal injury or death. Customers using or selling Vishay products not expressly indicated for use in such applications do so at their own risk. Please contact authorized Vishay personnel to obtain written terms and conditions regarding products designed for such applications.

No license, express or implied, by estoppel or otherwise, to any intellectual property rights is granted by this document or by any conduct of Vishay. Product names and markings noted herein may be trademarks of their respective owners.

# Mouser Electronics

Authorized Distributor

Click to View Pricing, Inventory, Delivery & Lifecycle Information:

## Vishay:

[BFC236825475](#) [BFC236825104](#) [BFC236855223](#) [BFC236825474](#) [BFC236825224](#) [BFC236821104](#) [BFC236821105](#)  
[BFC236821474](#) [BFC236821475](#) [BFC236821565](#) [BFC236821685](#) [BFC236825105](#) [BFC236825154](#) [BFC236825184](#)  
[BFC236825225](#) [BFC236825335](#) [BFC236825564](#) [BFC236825684](#) [BFC236828154](#) [BFC236841104](#) [BFC236841105](#)  
[BFC236841224](#) [BFC236841225](#) [BFC236843104](#) [BFC236845155](#) [BFC236845224](#) [BFC236845225](#) [BFC236845333](#)  
[BFC236845334](#) [BFC236845473](#) [BFC236845474](#) [BFC236845563](#) [BFC236845684](#) [BFC236848104](#) [BFC236848224](#)  
[BFC236851105](#) [BFC236851152](#) [BFC236851392](#) [BFC236855102](#) [BFC236855105](#) [BFC236855122](#) [BFC236855154](#)  
[BFC236855224](#) [BFC236855332](#) [BFC236855333](#) [BFC236855334](#) [BFC236855472](#) [BFC236855473](#) [BFC236855474](#)  
[BFC236855682](#) [BFC236855683](#) [BFC236855684](#) [BFC236858103](#) [BFC236858104](#) [BFC236861474](#) [BFC236863103](#)  
[BFC236865103](#) [BFC236865104](#) [BFC236865223](#) [BFC236865224](#) [BFC236865473](#) [BFC236865474](#) [BFC236865683](#)  
[BFC236866103](#) [BFC236866104](#) [BFC236866123](#) [BFC236866124](#) [BFC236866153](#) [BFC236866154](#) [BFC236866183](#)  
[BFC236866184](#) [BFC236866223](#) [BFC236866224](#) [BFC236866273](#) [BFC236866274](#) [BFC236866333](#) [BFC236866334](#)  
[BFC236866393](#) [BFC236866394](#) [BFC236866473](#) [BFC236866474](#) [BFC236866563](#) [BFC236866683](#) [BFC236866823](#)  
[BFC236867103](#) [BFC236867104](#) [BFC236867123](#) [BFC236867124](#) [BFC236867153](#) [BFC236867154](#) [BFC236867183](#)  
[BFC236867184](#) [BFC236867223](#) [BFC236867224](#) [BFC236867273](#) [BFC236867274](#) [BFC236867333](#) [BFC236867334](#)  
[BFC236867393](#) [BFC236867394](#)