

THIS DRAWING IS UNPUBLISHED. RELEASED FOR PUBLICATION
 © COPYRIGHT - By - ALL RIGHTS RESERVED.

REVISIONS					
P	LTR	DESCRIPTION	DATE	DWN	APVD
	U2	REVISED PER ECO-11-004587	11MAR11	RK	HMR
	V	REVISED PER ECO-17-002209	11APR2017	RS	MM

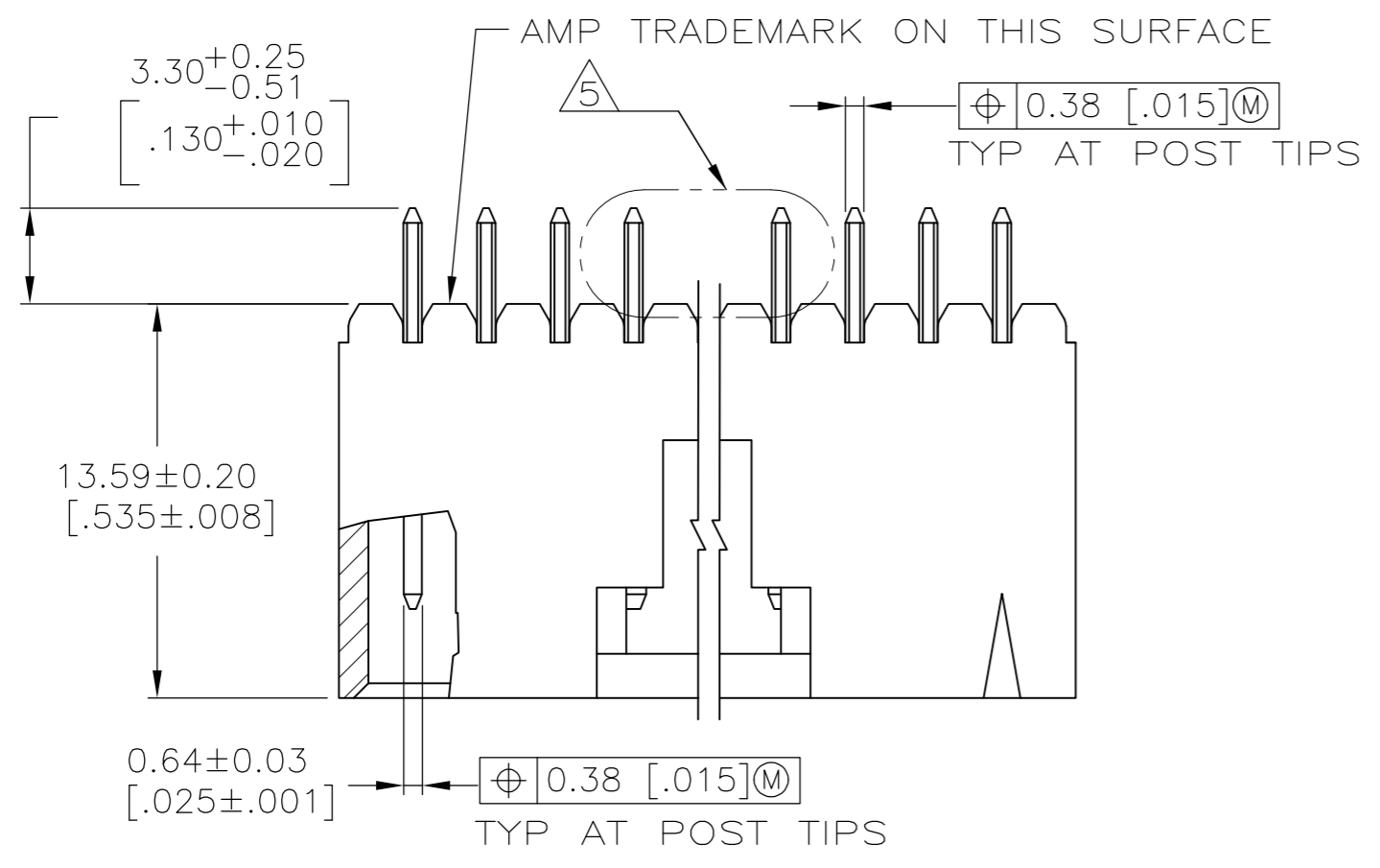

- 1 0.000381 [0.00015] GOLD IN THE CONTACT AREA, 0.00254-0.00508 [0.00100-0.00200] MATTE TIN-LEAD ON THE SOLDER TAIL, ALL OVER ALL OVER 0.00127 [0.00050] NICKEL.
- 2 POINT OF MEASUREMENT FOR PLATING THICKNESS
- 3 THE NOTED DIMENSIONS APPLY FROM THE BASIC DIMENSION LINE (NOT THE POST CENTERLINE) TO THE SURFACE INDICATED
- 4 ONE POLARIZATION SLOT FOR 2 AND 3 POSITION ASSEMBLIES ONLY.
- 5 SELECT POST TAILS FORMED TO PROVIDE CONNECTOR HOLD DOWN UNTIL SOLDERED, CONFIGURATION ACCEPTS 0.69-2.03 [0.027-.080] THICK PRINTED CIRCUIT BOARD (SEE DETAIL Z).
- 6 DIMENSIONS NOTED ARE FOR SOLDER STENCIL LAYOUT FOR USE WITH 1.57±0.20 [.062±.008] THICK PRINTED CIRCUIT BOARDS.
- 7 PARTS ARE PACKAGED IN GANG OF TUBES

- 8 OBSOLETE PART NO., REFER TO DWG 104909 FOR POS 13 THRU 25.
- 9 HOUSING: HIGH TEMPERATURE LCP, COLOR-BLACK. POSTS: BRASS.
- 10 0.000381 [0.00015] GOLD IN THE CONTACT AREA, 0.00254-0.00508 [0.00100-0.00200] MATTE TIN ON THE SOLDER TAIL, ALL OVER ALL OVER 0.00127 [0.00050] NICKEL.
- 11 SUPERSEDED

PART NO.	SUPERSEDED BY
1-104362-2	1-104909-2
1-104362-4	1-104909-4
1-104362-7	1-104909-7
2-104362-2	—
2-104362-3	—

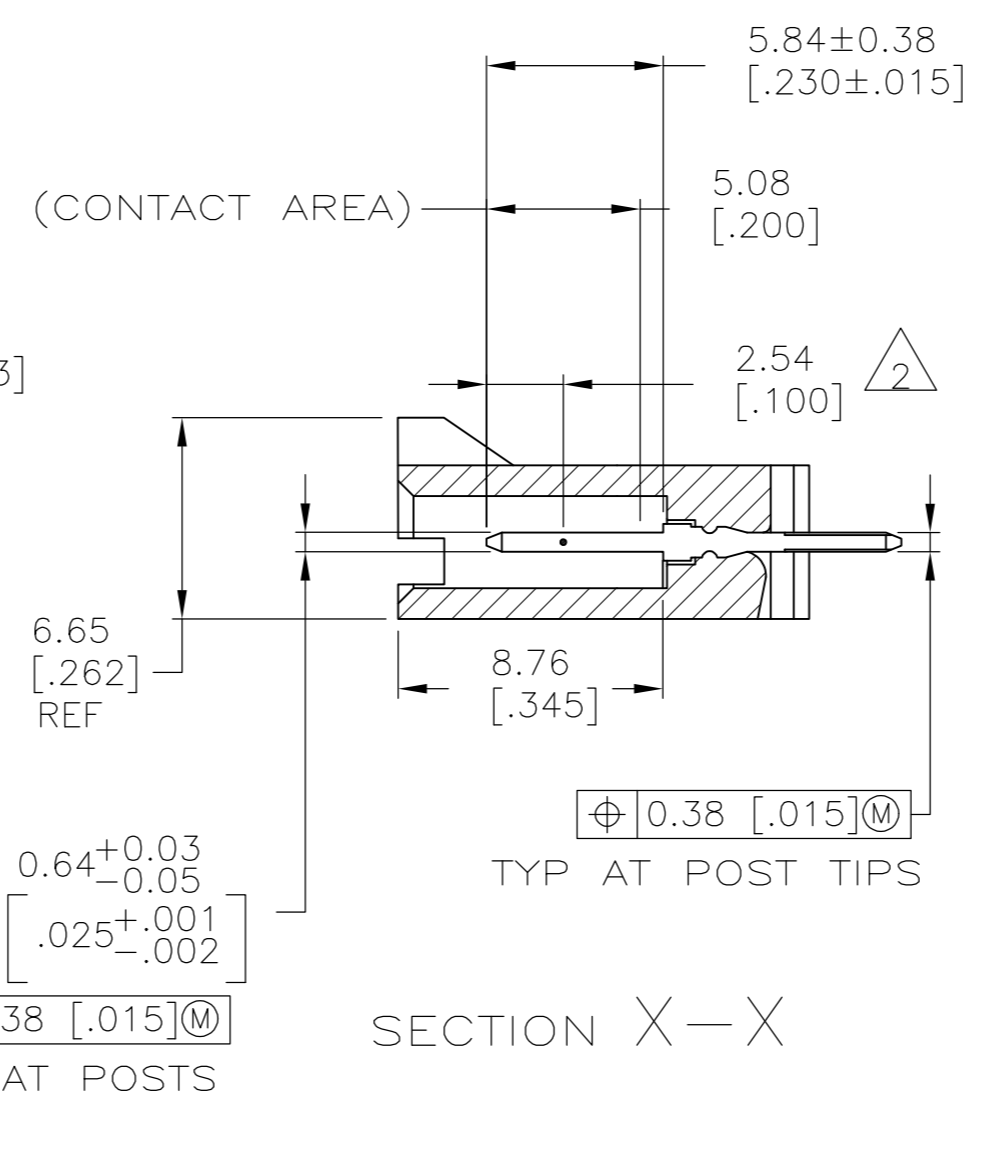
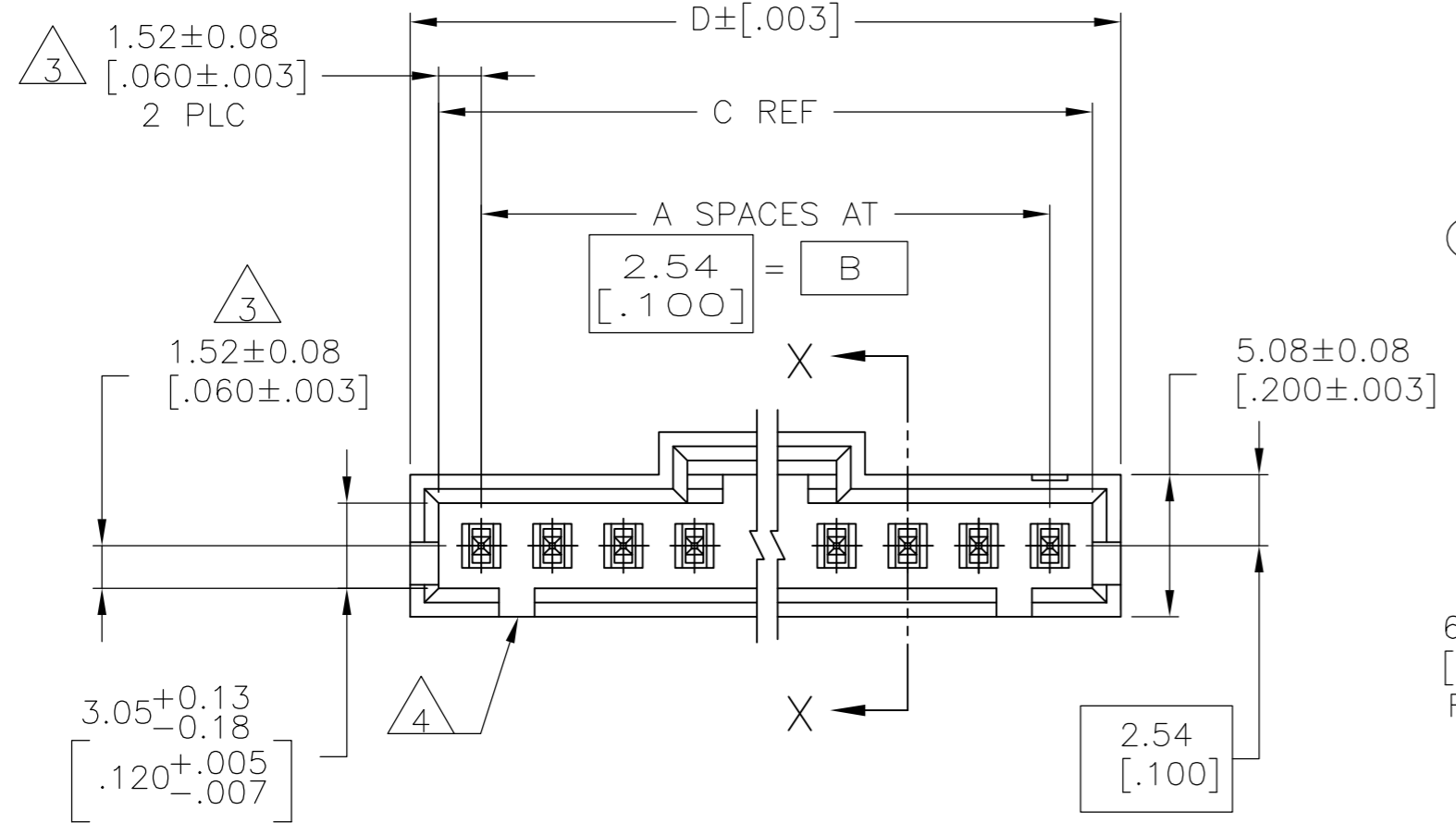

PLATING	D	C	B	A	NO OF POSN	ASSEMBLY PART NUMBER
10	32.89 [1.295]	30.99 [1.220]	27.94 [1.100]	11	12	6-104362-1
10	30.35 [1.195]	28.45 [1.120]	25.4 [1.000]	10	11	6-104362-0
10	27.81 [1.095]	25.91 [1.020]	22.86 [0.900]	9	10	5-104362-9
10	25.27 [0.995]	23.37 [0.920]	20.32 [0.800]	8	9	5-104362-8
10	22.73 [0.895]	20.83 [0.820]	17.78 [0.700]	7	8	5-104362-7
10	20.19 [0.795]	18.29 [0.720]	15.24 [0.600]	6	7	5-104362-6
10	17.65 [0.695]	15.75 [0.620]	12.7 [0.500]	5	6	5-104362-5
10	15.11 [0.595]	13.21 [0.520]	10.16 [0.400]	4	5	5-104362-4
10	12.57 [0.495]	10.67 [0.420]	7.62 [0.300]	3	4	5-104362-3
10	10.03 [0.395]	8.13 [0.320]	5.08 [0.200]	2	3	5-104362-2
10	7.49 [0.295]	5.59 [0.220]	2.54 [0.100]	1	2	5-104362-1
	65.91 [2.595]	64.01 [2.520]	60.96 [2.400]	24	25	2-104362-4
	63.37 [2.495]	61.47 [2.420]	58.42 [2.300]	23	24	2-104362-3
	60.83 [2.395]	58.93 [2.320]	55.88 [2.200]	22	23	2-104362-2
	58.29 [2.295]	56.39 [2.220]	53.34 [2.100]	21	22	2-104362-1
	55.75 [2.195]	53.85 [2.120]	50.8 [2.000]	20	21	2-104362-0
	53.21 [2.095]	51.31 [2.020]	48.26 [1.900]	19	20	1-104362-9
	50.67 [1.995]	48.77 [1.920]	45.72 [1.800]	18	19	1-104362-8
	48.13 [1.895]	46.23 [1.820]	43.18 [1.700]	17	18	1-104362-7
	45.59 [1.795]	43.69 [1.720]	40.64 [1.600]	16	17	1-104362-6
	43.05 [1.695]	41.15 [1.620]	38.1 [1.500]	15	16	1-104362-5
	40.51 [1.595]	38.61 [1.520]	35.56 [1.400]	14	15	1-104362-4
	37.97 [1.495]	36.07 [1.420]	33.02 [1.300]	13	14	1-104362-3
	35.43 [1.395]	33.53 [1.320]	30.48 [1.200]	12	13	1-104362-2
1	32.89 [1.295]	30.99 [1.220]	27.94 [1.100]	11	12	1-104362-1
1	30.35 [1.195]	28.45 [1.120]	25.4 [1.000]	10	11	1-104362-0
1	27.81 [1.095]	25.91 [1.020]	22.86 [0.900]	9	10	104362-9
1	25.27 [0.995]	23.37 [0.920]	20.32 [0.800]	8	9	104362-8
1	22.73 [0.895]	20.83 [0.820]	17.78 [0.700]	7	8	104362-7
1	20.19 [0.795]	18.29 [0.720]	15.24 [0.600]	6	7	104362-6
1	17.65 [0.695]	15.75 [0.620]	12.7 [0.500]	5	6	104362-5
1	15.11 [0.595]	13.21 [0.520]	10.16 [0.400]	4	5	104362-4
1	12.57 [0.495]	10.67 [0.420]	7.62 [0.300]	3	4	104362-3
1	10.03 [0.395]	8.13 [0.320]	5.08 [0.200]	2	3	104362-2
1	7.49 [0.295]	5.59 [0.220]	2.54 [0.100]	1	2	104362-1

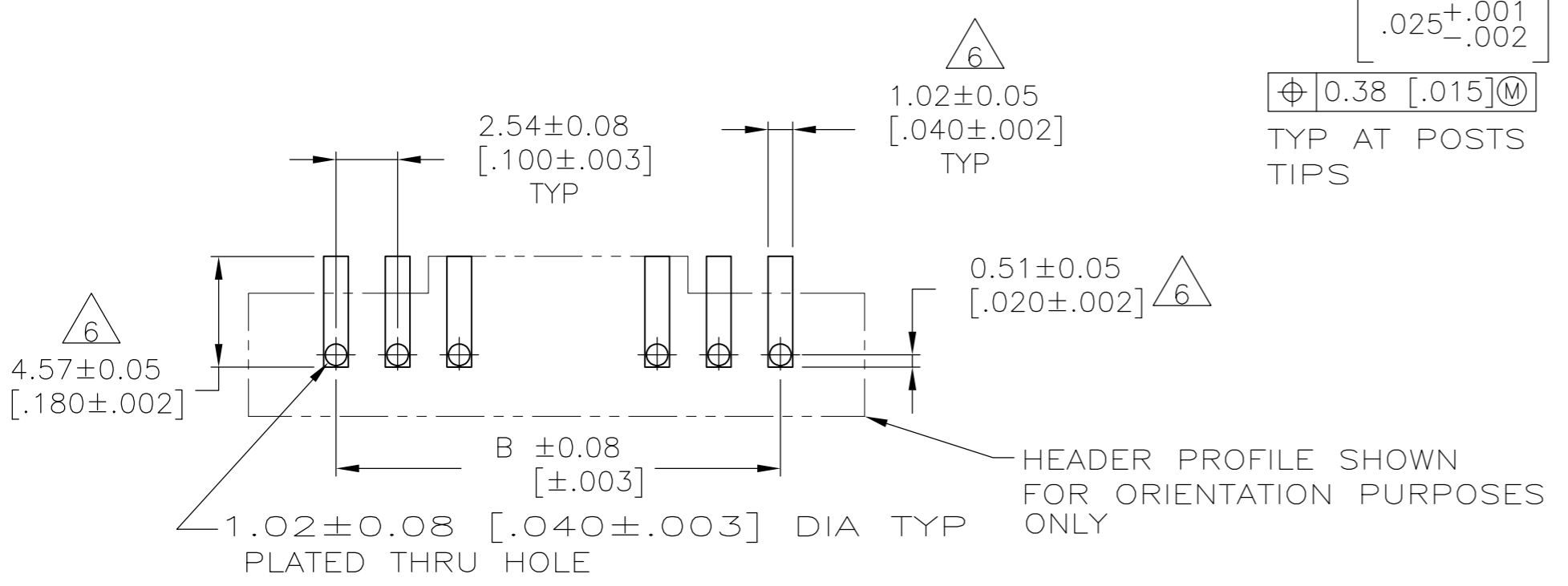

RECOMMENDED PC BOARD MOUNTING DIMENSIONS
 RECOMMENDED STENCIL THICKNESS = 0.25 [.010]

THIS DRAWING IS A CONTROLLED DOCUMENT. DWN G DOUTY 2-22-88
 CHK T C CLARK 2-22-88
 APVD - NAME -
 PRODUCT SPEC -
 APPLICATION SPEC -
 WEIGHT -
 CUSTOMER DRAWING

TE Connectivity
 HEADER ASSY, AMPMODU MTE, VERTICAL SINGLE ROW, .100 C/L, .025 SQ POST POLARIZED, WITH LATCHING & HOLD DOWN
 SIZE A2 CAGE CODE 00779 DRAWING NO C=104362 RESTRICTED TO -
 SCALE 4:1 SHEET 1 OF 1 REV V

Mouser Electronics

Authorized Distributor

Click to View Pricing, Inventory, Delivery & Lifecycle Information:

[TE Connectivity:](#)

[5-104362-5](#)