

Series 48EM

12MM MINIATURE SEALED ELECTRO-MECHANICAL

This rugged multi-option sealed pushbutton series offers the utmost in choices of mounting styles, colors, terminations, bezels, lighting and momentary or alternate-action switching. The Series 48 offers all these options in one compact package size.



APPLICATIONS

- Office equipment
- Medical equipment
- Industrial machinery
- Outdoor controls
- Mass transportation
- Food processing equipment

KEY FEATURES:

- Momentary or maintained action
- Gold contacts
- Many button colors
- Choice of LED colors (or non-lighted versions)
- Long life
- Solder, PC terminals or Wireleads
- Panel sealed to IP 67

ACTUAL SIZE

ORDERING INFORMATION:

Switch Function	Switch Termination	Module Type	Bezel Type	LED Color †	Button Color	Mounting Type	Voltage Resistor
Momentary	Solder Tabs	48-1	RB - Round, Black	N - None	RD - Red	B - Bushing	If Blank*
Maintained	Solder Tabs	48-2	SB - Square, Black	R - Red	GR - Green	S - Snap-fit	05 - 5V forward
Momentary	PC	48-5	RC - Round, Chrome	G - Green	BK - Black		
Maintained	PC	48-6	SC - Square, Chrome	Y - Yellow	BL - Blue		
Momentary	Wire Leads	48-A		A - Amber	YL - Yellow		
Maintained	Wire Leads	48-B		B - Blue	OR - Orange		
				W - White	CR - Chrome		
				RB - Red / Blue	PK - Black with Standby Symbol		
				RG - Red / Green	WH - White		

† Lighted switches come with wires on LEDs to protect from solder heat.

* Current limiting resistor is required to limit LED forward current to 20 mA (not included).

STANDARDS / AGENCY / RATINGS:



PRODUCT DRAWINGS

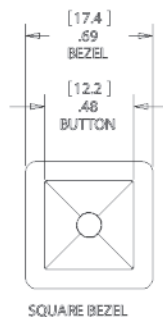
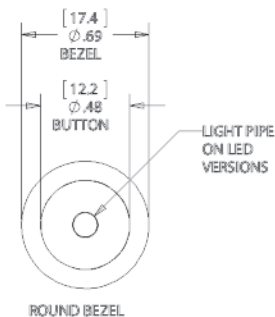
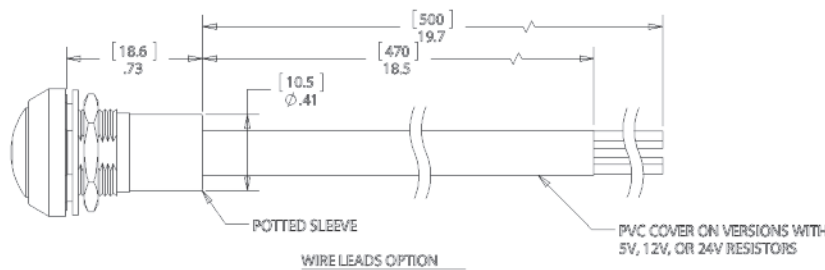
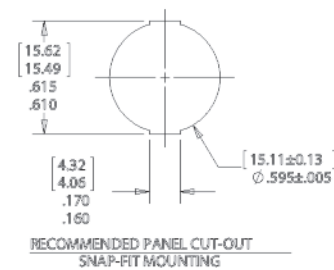
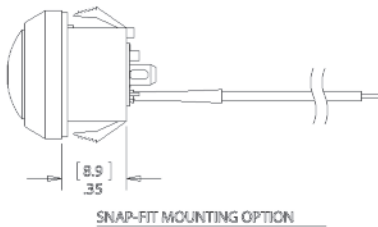
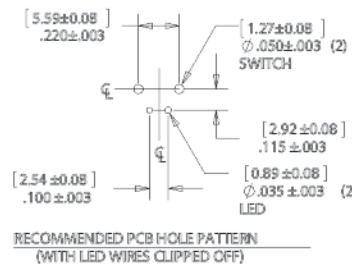
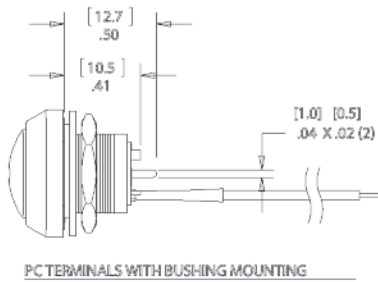
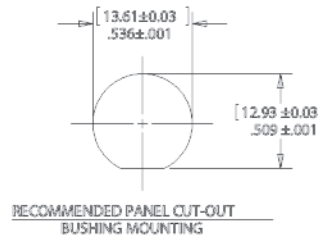
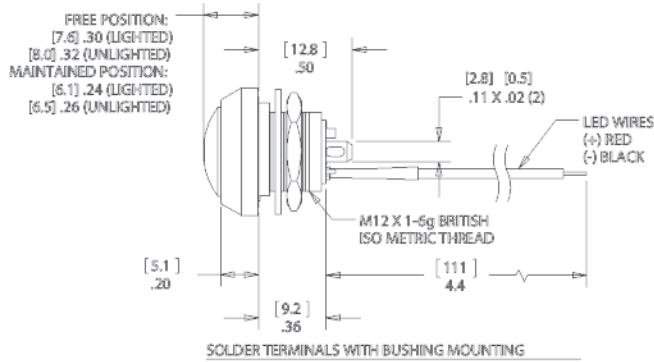

[MILLIMETERS]
 [INCHES]

MECHANICAL CHARACTERISTICS

CIRCUIT:
 SPST-NO-DB (FORM X)

BUTTON TRAVEL (NOM):
 [2.3] .09

OPERATING FORCE (NOM):
 [3N] 306g

CONTACT BOUNCE (NOM):
 1 ms

PANEL THICKNESS:
 BUSHING MOUNTING: [0.5-3.0]
 .02-.12
 SNAP-FIT MOUNTING: [1.3-3.0]
 .05-.12

NUT TORQUE (MAX):
 [11.5 kgf/cm] 10 lb/in

HARDWARE
 BUSHING MOUNTING: BULK
 PACKAGED SEALING WASHER
 AND HEX NUT ARE INCLUDED.

ENVIRONMENTAL SPECIFICATIONS

ACTUATOR INGRESS PROTECTION:
 IP67

OPERATING TEMPERATURE:
 [-40 C to +85 C] -40 F to +185 F

ELECTRICAL SPECIFICATIONS

CURRENT RATING (resistive):
 250mA @ 12VDC, 100K CYCLES
 150mA @ 28VDC, 150K CYCLES
 (MOMENTARY)
 100mA @ 48VDC, 100K CYCLES
 10mA @ 12VDC, 1 MILLION CYCLES
 (MOMENTARY)

DIELECTRIC STRENGTH:
 1,000 VAC

INSULATION RESISTANCE:
 1G OHM

CONTACT RESISTANCE:
 50m OHMS

WIRE LEADS:
 UL STYLE 1007
 26 AWG, STRANDED

Mouser Electronics

Authorized Distributor

Click to View Pricing, Inventory, Delivery & Lifecycle Information:

ITW Switches:

[48-7-RB-N-RD-B](#) [48-2-RC-N-CR-B](#) [48-1-SB-N-BK-B](#) [48-1-RB-N-BK-B](#) [48-1-SB-N-RD-B](#) [48-1-RB-N-RD-B](#) [48-5RB-G-BK-B](#) [48-5-RB-N-BK-B](#) [48-2-RB-R-BK-B](#) [48-7-RB-N-BK-B](#) [48-1-RB-R-BK-B](#) [48-2-RB-N-BK-B](#) [48-7-RC-N-CR-B](#) [48-2-RB-N-RD-B](#) [48-7-RB-R-BK-B](#) [48-1-RC-N-CR-B](#) [48-1-SB-R-BK-B](#) [48-1-SB-R-GR-B](#) [48-3-RB-N-BK-B](#) [48-1-RB-N-YL-B](#) [48-1-RB-N-GR-B](#) [48-1-RB-N-OR-B](#) [48-1-RB-N-BL-B](#) [48-1-RB-N-BK-S](#) [48-2-RB-W-YL-B-05](#) [48-2-RB-W-YL-B](#) [48-1-RB-G-BK-B](#) [48-1-RB-N-RD-S](#) [48-A-SB-N-WH-S](#) [48-A-SB-N-BK-S](#) [48-A-SB-N-RD-B](#) [48-A-SB-N-GR-B](#) [48-A-SB-N-BK-B](#) [48-A-SB-N-BL-B](#) [48-A-RB-N-YL-B](#) [48-A-RB-N-OR-B](#) [48-A-RB-N-WH-B](#) [48-5-RB-G-BK-B](#) [48-2-RB-N-GR-B](#)